

PEDESTRIAN FEATURES



CREATING AN ATTRACTIVE DESTINATION

The design, scale and quality of buildings, streets and landscaping can create TOD areas that are pleasant places to walk, bike, relax and attract people. Pedestrian safety and comfort are crucial to the success of transit-oriented development.

Public areas or places around the transit stops or stations can be part of a community or neighborhood “lifestyle center” that is friendly to pedestrians. Features could include public plazas, pedestrian malls, outdoor markets, decorative gardens or other public amenities.

BUILDING PLACEMENT AND FEATURES

Building Placement

Buildings can create an attractive environment for pedestrians by being close to the sidewalk. Putting street-facing buildings at the street with minimal setbacks helps "define" the sidewalk as a pedestrian environment, adds activity and architectural variety to the sidewalk and street, and creates an interesting environment for walking.

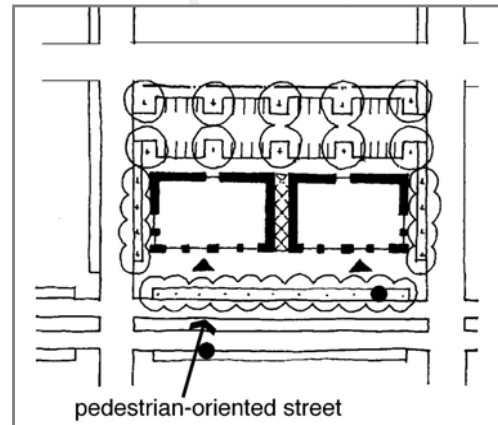

KEY:
▲ Building Entrance
● Transit Stops

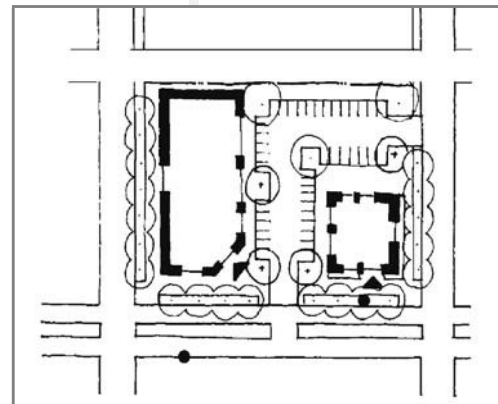

KEY:
▲ Building Entrance
● Transit Stops

Ideally, buildings in a TOD line the majority of a pedestrian-oriented street's frontage

Some breaks in the building line and narrow parking lots between buildings are workable as long as there is sufficient street-facing frontage.

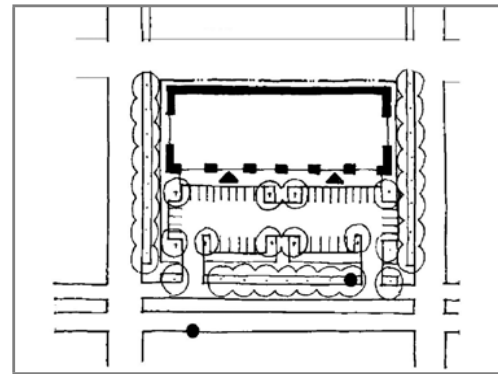

KEY:
▲ Building Entrance
● Transit Stops

Windows and Entries

Having recurring windows and multiple entries helps keep an "eye" on the street, making the street safer for pedestrians, and making the street a more interesting walking environment.

Street-facing facades that are relatively blank and parking lots in front of buildings are not friendly to pedestrians.

Rule of Thumb

Minimum amount of ground-floor window space in central TOD area = 40 percent of building's length



Display windows are an option but not mirrored windows or clerestory (high-level windows that admit light while preventing outsiders from looking in).

Mixed-use and commercial buildings in a TOD address neighborhood streets with entries and windows, not blank walls or loading docks.

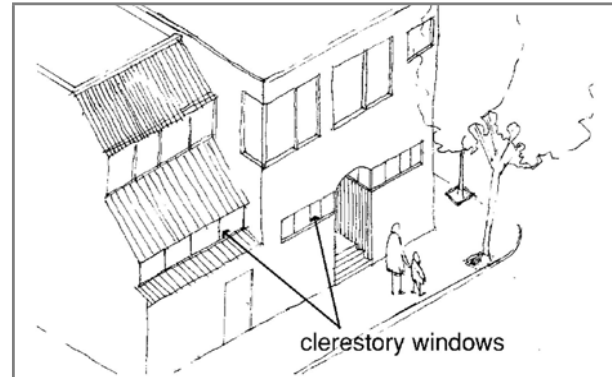

Clerestory windows do not provide “transparency” between public and private spaces and, consequently, can detract from a pedestrian-friendly environment.

Building Height

Multi-story buildings provide definition and a sense of enclosure to the street and establish a sense of vitality (see sketch below).

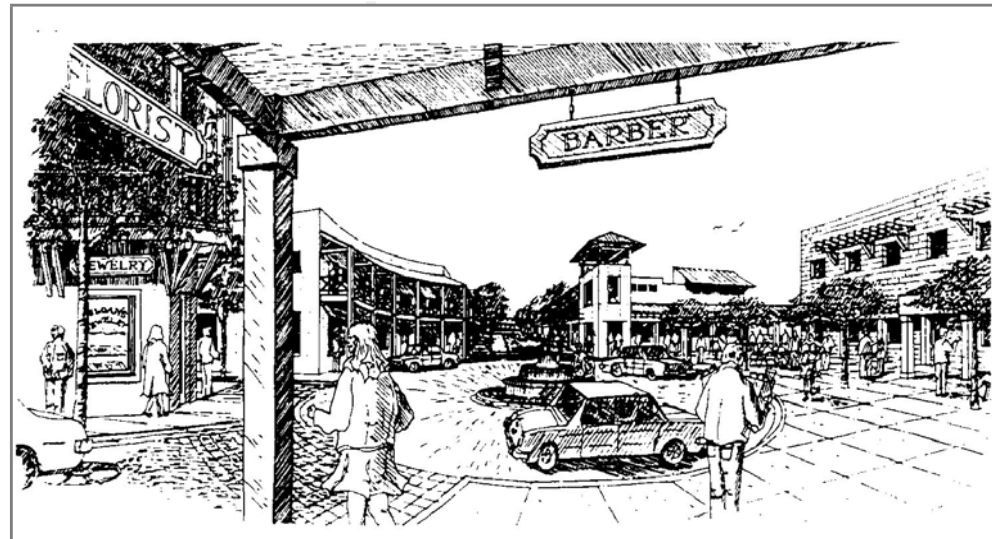

DESIGN FOR CLIMATE

Arcades, awnings and other overhangs on buildings can mitigate the effects of the region's snowy winters and hot summers. Building design and placement need to provide enough room for snow storage so that pedestrian movement is not impeded as the winter progresses and snow banks get larger and higher.

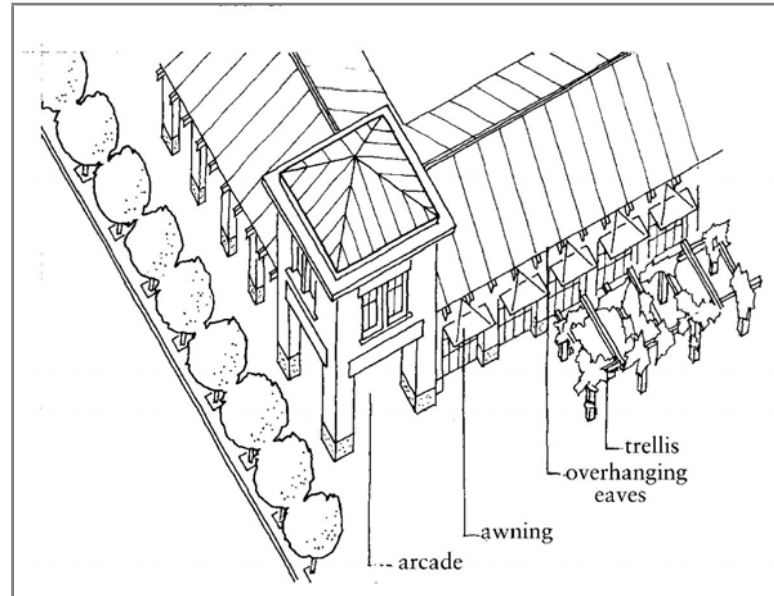

Shelters, such as awnings, arcades and trellises, can help protect pedestrians from summer heat and winter cold.

STREET CONNECTIONS

A grid of pedestrian-scaled streets enhances accessibility between the areas nearest the transit stop or station, on one hand, and the adjacent commercial, residential and civic areas, on the other. An interconnected network of streets minimizes walking and cycling distances and distributes traffic to reduce volumes on local streets.

Streets with sidewalks and pedestrian paths through the TOD offer direct, quick connections to transit and the area next to it. Neighborhood or local streets are narrow, to slow down drivers and thus “calm” automobile traffic to speeds that are more compatible with children, pedestrians and cyclists. Through traffic remains outside the TOD, on larger, arterial streets.

Rules of Thumb

Minimum internals for streets through TOD:

- Suburban settings = every 1,200 feet.
- Urban settings = every 800 feet
- Pedestrian connections = more frequent intervals.

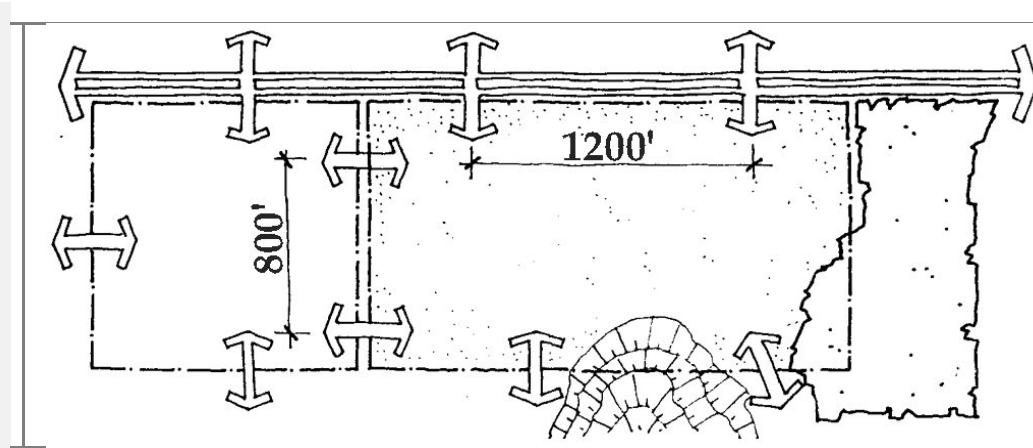

Frequent access points and local connections help distribute traffic and create a pedestrian friendly street network. (The dimensions shown here are maximum desirable separations; more frequent connections are preferred).

The addition of internal street or alley connections can break up the scale of mega-blocks in existing suburban areas. Existing cul-de-sacs could be connected back to through-streets, either with automobile-accessible roads or pathways.

STREET DESIGN

Streets in TODs can be designed to slow traffic and minimize pedestrian crossing distances, while accommodating reasonable traffic demand levels and access requirements for emergency vehicles.

Traffic management and convenient pedestrian street crossings are especially important in the TOD, surrounding transit stops or stations and other areas where high levels of pedestrian activity are expected. Narrower roadway widths, raised crosswalks, and other traffic calming strategies help slow and manage automobile traffic so that pedestrians feel more comfortable.

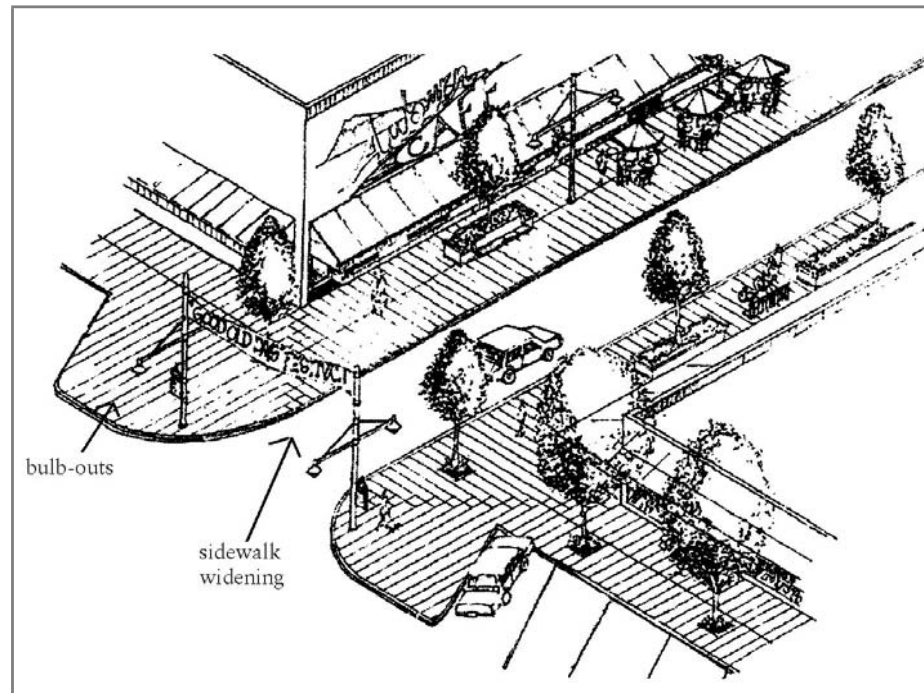

Small changes to street widths can make a big difference in creating a pedestrian-friendly environment. (Graphic source: "Creating Transit Station Communities," Puget Sound Regional Council, 1999)

Traffic calming techniques can reduce and slow traffic on streets in the TOD central area. Existing wide roadways can be narrowed to "tame the street" by, for example:

- Adding on-street parking
- Widening sidewalks
- Adding center median planting strips or
- Using "bulbs-outs" (where sidewalks are widened into the parking lane of streets at pedestrian crossings) at corners.

Drainage and snow removal and storage are factors to consider in the design and maintenance of these features.

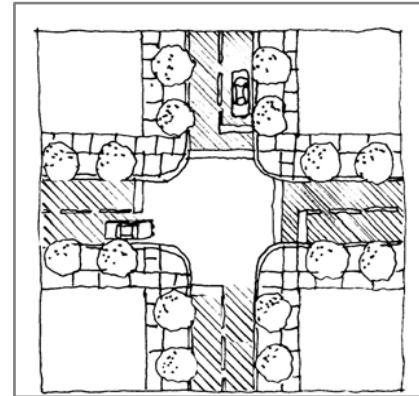
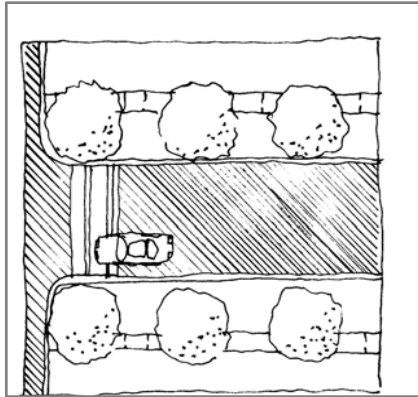

Left: Textured crosswalk paving such as brick, helps slow down cars at intersections, making pedestrian crossings safer. Brightly painted crosswalks help as well.

Right: Raised and/or textured intersections force cars to slow down through an entire intersection.

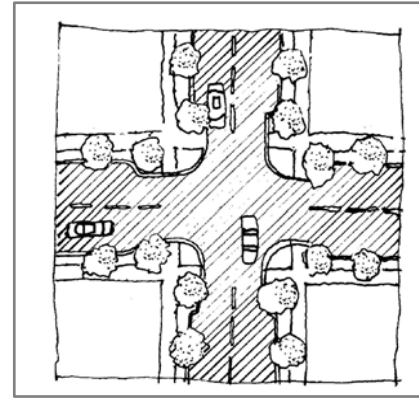
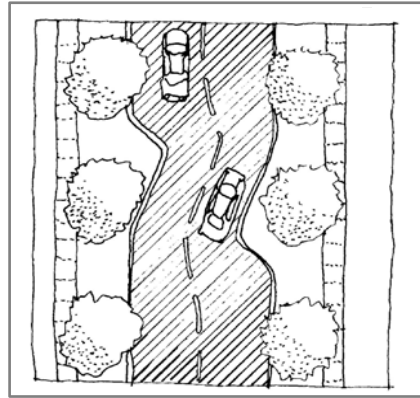

Left: Angled slow points (left) are curbed or other physical barriers to a straight path on a roadway.

Right: Knockdowns or bulb-outs narrow the intersection or at mid-block. They preserve room for on-street parking and make it easier for pedestrians to cross otherwise-wide streets.

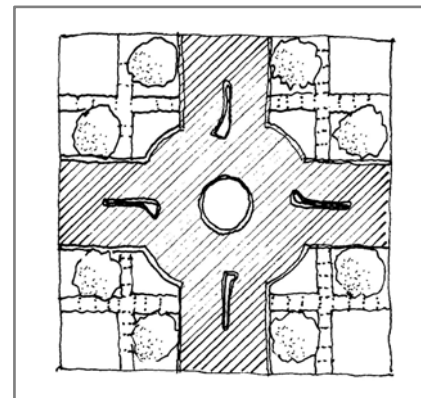
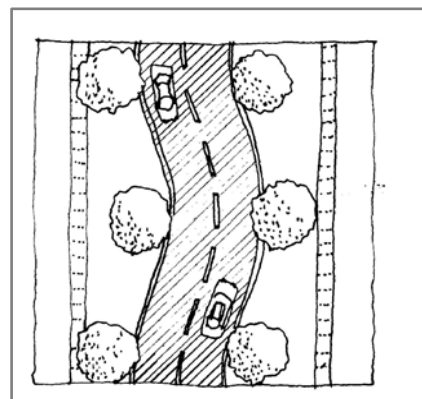

Left: Chicanes are another example of varying the roadway alignment to slow down traffic.

Right: Roundabouts deflect cars out of their straight-line path through an intersection. Adding landscaping also helps break up the uninterrupted sight lines, which encourage drivers to speed.

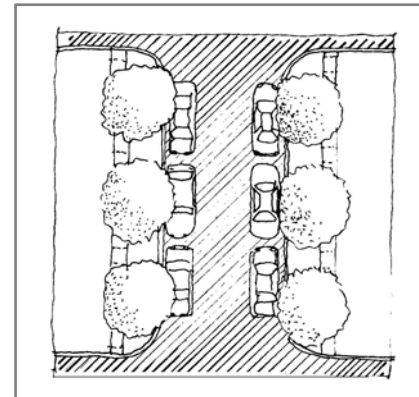
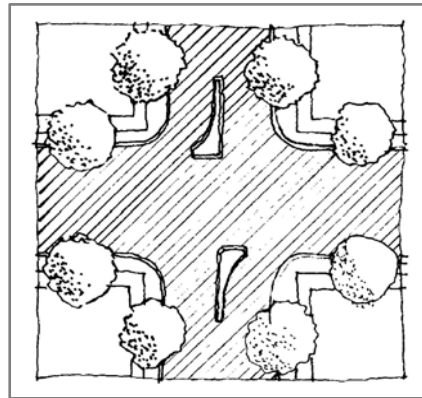

Left: Forced-turn barriers also help change the traffic routes through a neighborhood, while allowing traffic on a through street to remain unchanged.

Right: Street narrowing by adding on-street parking or re-striping the street to narrow driving lanes creates a wider parking lane, which can also function as a cycling path.

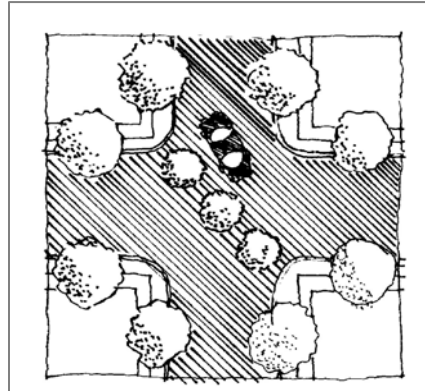

Left: Diagonal road closures can reduce or slow cut-through traffic. The closure can be a continuous planted strip, bollards, or circular planters. Bollards and planters enable bicycle access through the barrier.

STREET ALIGNMENT

Local street alignments should discourage high volumes of through traffic in the TOD. High volumes of through traffic should remain outside the TOD.

Retail businesses that traditionally locate on high-traffic streets to be visible to through traffic can still be sited on an arterial that defines the edge of a TOD, adjacent to the transit station and other public services.

Streets within TODs can be offset using T-intersections to slow traffic. Traffic calming measures can also discourage through traffic by reducing speeds on local streets.

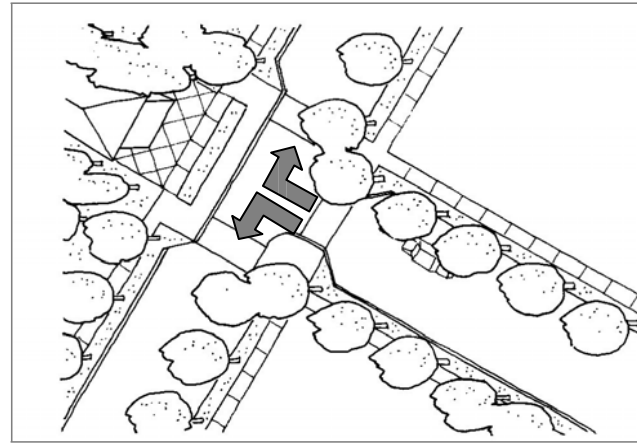

When heavy traffic adversely affects neighborhood streets, road closures can convert 4-way intersections to T-intersections while retaining pedestrian and bicycle connections.

SIDEWALKS

The design of sidewalks is crucial in TODs and surrounding areas. A planting strip with street trees is one way to separate sidewalks from roadways. Street trees and planting strips enhance neighborhoods, separate pedestrians from cars, shelter pedestrians from hot summer sun, and provide a location for snowplows to dump snow without blocking sidewalk paths.

Planning efforts to retrofit developed areas can explore methods to fit in street trees and other pedestrian amenities. Examples include retrofitting planting strips, widening sidewalks or planting trees in “bulb outs” within parking lanes. Widened sidewalks also allow greater maneuverability by wheelchair users.

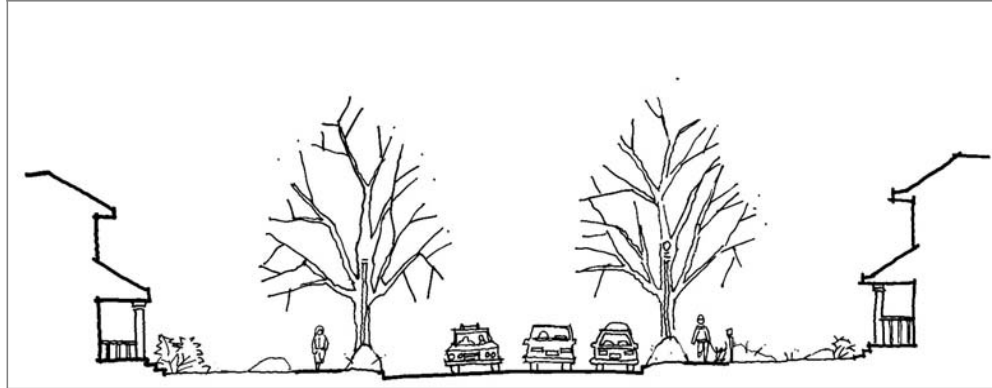

Planting strips between curbs and sidewalks, with recurring shade trees, make walking a pleasant experience, buffer pedestrians from street traffic and provide a place for plows to dump snow.

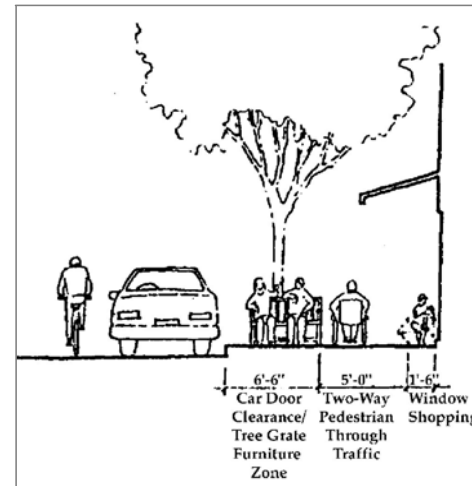
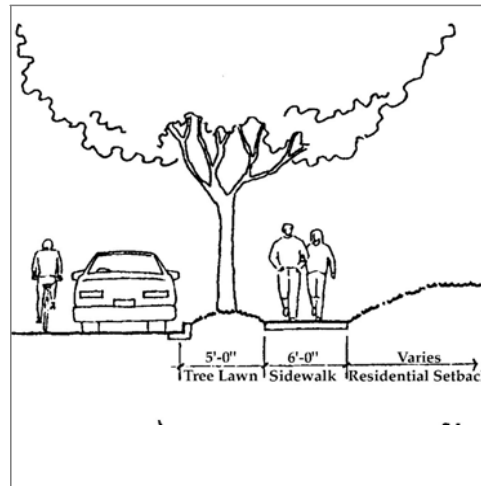

Sidewalks can be scaled to their level of use. While continuous planting strips are appropriate in residential areas, continuous sidewalks with tree wells may be more appropriate in front of retail shops.

BIKE FACILITIES

In the absence of safe, low automobile-traffic routes, bike lanes can be established along major arterial streets, linear open spaces or railroad rights-of-way, especially to connect to transit. Bike lanes along arterial streets beyond the TOD create paths for cyclists to get into TODs and other destinations.

CONNECTIONS TO SURROUNDING AREAS

The slower traffic and lower volumes on local streets in the TOD make them amenable to bicyclists riding in the same travel lanes as automobile traffic.

Bus movements, stops, and staging areas should be designed to minimize conflicts with bicyclists.

Mn/DOT provides State Aid Standards for combined bike/pedestrian facilities. The department also has adopted Bicycle Transportation Planning and Design Guidelines. The American Association of State Highway and Transit Officials (AASHTO) provides similar guidelines.

Street and trail connections should extend into adjacent areas to encourage walking and bicycling to TOD conveniences and transit.

In the surrounding area, frequent street and trail connections to the TOD will encourage pedestrian and bicycle trips to the core and facilitate the use of TOD transit, retail, and public facilities by surrounding area residents and employees.

The distance from the core area of a TOD measured in terms of walking time usually 5-8 minutes or one-quarter mile (1,300 feet) and may extend one-half mile around transit stop or extend to ½ mile around transit stop or each side of a centerline of a transitway.

BARRIER-FREE ACCESS

The Americans with Disabilities Act (ADA), with its statutory requirements, has raised public awareness of designing building and their surroundings for people with disabilities.

Building design and site planning in TODs should provide special attention to creating barrier-free environments to enable the disabled and mobility impaired, the elderly or parents with baby strollers, to move easily without restrictions through public spaces.

Barrier-free accessibility includes access to transit stops and stations and to the retail, civic, employment and residential uses found in a TOD.

Planning for accessibility requires thinking through the trip a person with a disability makes from beginning to end. In particular, site and building design should provide:

- Sufficient width and maneuvering room to accommodate people using wheelchairs;
- Features that require turning or reaching (such as door openers, ticket machines, and other devices) that are designed to be usable by everyone;
- Tactile or audible cues to allow the vision-impaired to move about independently;
- Visible cues for hearing-impaired;
- Short, smooth, direct, well-signed routes, preferably on level ground and weather-protected, to minimize distances that disabled and elderly people should travel between transit, building entrances, and other common destinations;
- Accessible, comfortable waiting and rest areas.