



Southwest LRT (METRO Green Line Extension) Project

Supplemental Draft EIS Comments

**Public Comments at the Eden Prairie Public Hearing, June 17, 2015**

July 2015



Public Hearing - 6/17/2015  
Southwest Green Line LRT Extension

1  
2  
3  
4  
5  
6  
7  
8  
9  
10  
11  
12  
13  
14  
15  
16  
17  
18  
19  
20  
21  
22  
23  
24  
25

-----  
In re: )  
Public Hearings on Southwest )  
Green Line LRT Extension )  
-----

TRANSCRIPT OF PROCEEDINGS

The following is the transcript of proceedings,  
taken before Rebekah J. Bishop, Notary Public, Registered  
Professional Reporter, Certified Realtime Reporter, at the  
Eden Prairie City Hall, 8080 Mitchell Road, Eden Prairie,  
Minnesota 55344, commencing at 6:03 p.m. on June 17, 2015.

**Public Hearing - 6/17/2015**  
**Southwest Green Line LRT Extension**

1  
2  
3  
4  
5  
6  
7  
8  
9  
10  
11  
12  
13  
14  
15  
16  
17  
18  
19  
20  
21  
22  
23  
24  
25

A P P E A R A N C E S

Metropolitan Council:

Adam Duininck  
Jennifer Munt  
Steve Chavez  
Deb Barber  
Gary Cunningham



**Public Hearing - 6/17/2015**  
**Southwest Green Line LRT Extension**

1 P R O C E E D I N G S

2 MR. DUININCK: The room got quiet; that must  
3 mean it's time to start. Good evening, everyone.  
4 Welcome. Thanks a lot for being here.

5 Welcome, this is a hearing on the  
6 supplemental DEIS being held by the Metropolitan  
7 Council, by myself, Adam Duininck, and a bunch of  
8 council members which I'm glad to introduce:

9 Good evening, Jennifer Munt, who has been  
10 very active on this corridor on the CAC -- she coaches  
11 the CAC, the Citizens' Advisory Committee; Council  
12 Member Deb Barber from Scott and Carver County, most  
13 of -- both of those counties; and Council Member Gary  
14 Cunningham, who represents Minneapolis and a couple of  
15 communities just north and west of Minneapolis.

16 So, good evening. Before we get to the more  
17 formal part of the program to take testimony and  
18 everything from the folks that have signed up, we're  
19 going to have a quick presentation from Nani Jacobson  
20 from the project office.

21 (Per request, presentation not reported.)

22 MR. DUININCK: All right. Thank you, Nani.  
23 Thanks for the presentation.

24 Before we get started, I just want to  
25 recognize a few other folks who have joined us: One,

**Public Hearing - 6/17/2015**  
**Southwest Green Line LRT Extension**

1 Council Member, Steve Chavez, from Dakota County, and  
2 Hennepin County Commissioner, Jan Callison. Thanks a  
3 lot for being here, Jan, and for all your work on this  
4 project.

5 Before we get started, I just want to just  
6 mention a few, kind of, ground rules here. Tonight is  
7 focused on the draft DEIS. There might be questions --  
8 other questions related to the project, certainly, with  
9 what's been in the news for the last couple months.  
10 Please feel free to talk to our project office staff  
11 about that and the council members and myself about  
12 that after the meeting, but for the purpose of the  
13 public hearing, it's to -- to comment specifically on  
14 the supplemental draft environmental impact statement.

15 Individuals will have up to two minutes to  
16 give their presentation; groups up to three minutes.  
17 And I just ask that you state your name and address for  
18 the record. I'll do my best to read the handwriting  
19 and pronounce your name, so hopefully I -- as somebody  
20 who has his name routinely butchered, I'll try to do my  
21 best to pronounce everyone's names.

22 And I also just want to remind everyone that  
23 if you're not interested in speaking tonight, you have  
24 other ways to comment via e-mail and mail and certainly  
25 with registering your comments with us here tonight in

**Public Hearing - 6/17/2015**  
**Southwest Green Line LRT Extension**

1 person. We did extend the public comment period 15  
2 days to July 21st, so there still is just about a  
3 month -- a little bit over a month to give comment.

4 So with that, we'll begin going through the  
5 names. We've only had five people sign up tonight. So  
6 I'm not going to be too strict of an enforcer on the  
7 time, but we do want to respect everyone else's time  
8 here who is here tonight.

9 So, first, we will hear from Bob Carney.

10 EP-01 MR. CARNEY: Thank you.

11 MR. DUININCK: You ready?

12 MR. CARNEY: Oh, yeah.

13 Bob "Again" Carney, Jr., Minneapolis,  
14 Minnesota, 4232 Colfax Avenue South. Just by way of  
15 disclosure, I'm a registered lobbyist for "We the  
16 People," an informal association. I spoke yesterday.

17 Very briefly, first of all, the draft -- the  
18 Supplemental Draft Environmental Impact Statement,  
19 Section 5.2 says, "Remaining funding is assumed to come  
20 from . . . the State, 10 percent."

21 Now, as -- as many know, at this point, the  
22 State legislature cancelled \$30 million in  
23 appropriation from 2013 for Southwest Light Rail. That  
24 brings the total the State has put in to about  
25 \$15 million.

**Public Hearing - 6/17/2015**  
**Southwest Green Line LRT Extension**

1                   The current plan, as I understand it, is to  
2                   try to cut back from \$2 billion to \$1.65 billion.  
3                   Ten percent of \$1.65 billion is \$165 million, so the  
4                   State is \$150 million short at this point.

5                   I talked with Speaker Daudt at the special  
6                   session. I asked him, "Is there any chance of the  
7                   legislature putting more money into Southwest Light  
8                   Rail next year?" He said, "No."

9                   So unless money comes from somewhere else --  
10                  and my understanding is CTIB said they're not going to  
11                  go anywhere above 1.65; I don't know what Hennepin  
12                  County has said. Unless money comes from somewhere  
13                  else, there is a \$300 million shortfall in the dollars  
14                  available for the project.

15                  In addition, I'm very concerned about the  
16                  idea of continuing to spend to get to the point where  
17                  you say, "Well, we have to do it now because we've  
18                  spent so much."

19                  Now, the current reported number has been  
20                  \$59 million spent so far, but I have an e-mail from a  
21                  project engineer at Hennepin County who is working on  
22                  this. I asked him what the current spending for the  
23                  railroad authority has been, and he said \$34 million.  
24                  The number that I have from Met Council is  
25                  \$10.9 million.

**Public Hearing - 6/17/2015**  
**Southwest Green Line LRT Extension**

1 I'm showing, actually, the total spending is  
2 closer to \$90 million, but my real concern is that when  
3 you look at the amount that is scheduled to be  
4 disbursed from CTIB this year and the amount that is  
5 budgeted for Hennepin County and has not yet been  
6 spent, we're looking at an additional \$67.3 million.

7 My real concern is that a very hard look  
8 needs to be taken at whether we should simply freeze  
9 spending at this point. This project is in such deep  
10 trouble. It has been cut already so substantially in  
11 terms of threatening viability, and now the money  
12 available is -- is in such doubt that we simply need to  
13 stop and take a look at whether we should simply put a  
14 freeze and go back to the drawing board.

15 Thank you.

16 MR. DUININCK: Thank you.

17 The next speaker is Melitta Mayer.

18 EP-02 MS. MAYER: Hi, I'm a resident of Eden  
19 Prairie, and I live at 13175 Spencer Sweet Pea Lane.

20 I am just going to keep this very short and  
21 sweet. I am totally against the LRT project. I think  
22 it's horribly costly, overly expensive, and we have a  
23 great bus system. The Southwest bus system should be  
24 expanded, made bigger and better. It's already in  
25 place; there's nothing wrong with it. Why can't we

**Public Hearing - 6/17/2015**  
**Southwest Green Line LRT Extension**

1           just expand that and take whatever remaining money  
2           there is, fix our roads and our bridges?

3                       That's all I want to say. Thank you.

4                       MR. DUININCK: All right. Thank you for your  
5           comments.

6                       Next speaker is Nancy Arieta.

7           EP-03 MS. ARIETA: You want me real close?

8                       MR. DUININCK: Yes, that would be great.  
9           Thanks.

10                      MS. ARIETA: Thanks, everybody, for doing the  
11           hard work. I appreciate the task; I don't appreciate  
12           light rail. There's a lot of misgivings that I have;  
13           one thing, in particular, is the cost. And I agree  
14           with the last speaker, our bus system is fantastic.  
15           I'm always in favor of that.

16                      I also want to say the cost is horrendous,  
17           and because we're being pushed by the knowledge of  
18           federal dollars, and if we don't do this and we don't  
19           do that, I hope I'm correct in saying that there's a  
20           push and a shove behind all this.

21                      As I understand, from what I heard speaking  
22           to people, too, a lot of it was an agreement with  
23           United Health that pulled a lot of this together, and I  
24           didn't -- I didn't like that idea very much on that.

25                      Making us go forward with something may not

**Public Hearing - 6/17/2015**  
**Southwest Green Line LRT Extension**

1           be the best thing. Progress is not always good. As a  
2           matter of fact, progress can also create a whole bunch  
3           more dilemmas. I see the accidents happening on  
4           University, the accidents on Hiawatha. I drive the  
5           Hiawatha area frequently, and I see -- I just see the  
6           mess that occurs a lot, and traffic tie-ups, snarls,  
7           people being in -- in danger by trying to scurry across  
8           things.

9                         Anyway, I'm not for the light rail. My son  
10           disagrees with me, but that's okay.

11                        Thank you for hearing me.

12                        MR. DUININCK: Thank you. Thank you very  
13           much.

14                        The next person is Ellen --

15           EP-04 MS. HOERLE: Hoerle.

16                        MR. DUININCK: Hoerle. Thank you.

17                        MS. HOERLE: Well, I wasn't sure what I was  
18           going to speak about, and I still am not, so -- but I'm  
19           here to support; I'm sorry. I am so thankful for you  
20           guys, and I'm so thankful for this project. And I  
21           don't commute, but I -- every time I try to get  
22           downtown in the evening, and any time of day, anywhere,  
23           it's a nightmare, and it's an hour to get downtown.

24                        One day I -- okay. So we have two  
25           representatives; we have David Hann, and we have

**Public Hearing - 6/17/2015**  
**Southwest Green Line LRT Extension**

1 Jenifer Loon. And both of them have been opposed to  
2 any money, one penny being spent on light rail.

3 And after they had -- was it last year we had  
4 a primary -- Republican Jennifer Loon was all about --  
5 wonderful about how she supported the intersection  
6 of -- the improvements of 494 and 169. And I had to go  
7 downtown at about 5:00 in the afternoon, and as soon as  
8 I went through that brand-new intersection, I ran into  
9 a parking lot, because I was headed east on 494. It  
10 took me an hour to get to downtown.

11 If my -- if I -- we had Southwest Light Rail,  
12 my person I was picking up, he could have taken it from  
13 the bus. And he could have taken it all the way out to  
14 Eden Prairie, and I would have never had to go  
15 anywhere. I spent an hour getting there and an hour  
16 back. That's an hour of my time and my gas and  
17 everything else.

18 It requires private investment on my part to  
19 purchase a car to -- and that's what people don't  
20 understand. They say, "Oh, the cost is so high," but  
21 that's -- but you're getting a system. You're getting  
22 a system where you can sit in a seat, and you can take  
23 from Eden Prairie and go all the way to St. Paul. And  
24 you can sit there and -- and do whatever you want,  
25 so -- instead of having to spite traffic and, you know,



**Public Hearing - 6/17/2015**  
**Southwest Green Line LRT Extension**

1           ruin the environment and everything else.

2                       So I am so supportive of this project, and so  
3 I had -- once I heard everyone was against it, I'm  
4 like, "I'm going to get up and speak."

5                       The other thing is it's just so good for  
6 everybody -- I mean, for this community. And it's just  
7 going to create so many more options for people to get  
8 out of this community in the evening and then for  
9 people to come -- come here, you know, in the evening  
10 and all of the wonderful things I've been -- you know,  
11 with the Green Line and how the ridership is well  
12 beyond projections.

13                      I'm just -- I'm just here to support. So,  
14 you've got my name, and so -- I live in Eden Prairie,  
15 too. I forgot to say that part.

16                      MR. DUININCK: Thank you. Thank you very  
17 much for your comments.

18                      Yeah, just a reminder, if you'd state your  
19 name and address for the record.

20                      Next is Joseph Lange [sic].

21                      EP-05 MR. LAMPE: Lampe, L-A-M-P-E.

22                      MR. DUININCK: Oh, M-P. I'm sorry.

23                      MR. LAMPE: I may not have printed that  
24 clearly.

25                      MR. DUININCK: No problem.

**Public Hearing - 6/17/2015**  
**Southwest Green Line LRT Extension**

1                   MR. LAMPE: I'm here to try to save the  
2                   project.

3                   MR. DUININCK: All right. Thank you.

4                   MR. LAMPE: I have a 60-page submission of  
5                   exhibits. You will get one by mail. I didn't think to  
6                   bring yours; I wasn't sure you'd be here tonight. But  
7                   I can turn in this unaddressed blank.

8                   This is quite a dramatic change to the  
9                   project, but it will save a lot of money and provide a  
10                  very superior experience for Eden Prairie. In terms of  
11                  environment impacts, think about no vibration or  
12                  acoustic noise, no buried cable ducts, no at-grade  
13                  street crossings or trail crossings, no pilings or  
14                  retaining walls --

15                  AUDIENCE MEMBER: He's not -- I -- we don't  
16                  hear him.

17                  MR. LAMPE: You're not hearing?

18                  MR. DUININCK: A little closer, please.

19                  MR. LAMPE: This thing is aimed low. I'll  
20                  try to kiss it; is that better?

21                  AUDIENCE MEMBER: Yes.

22                  MR. LAMPE: Thank you. These are all  
23                  environmental improvements that would result from the  
24                  plan that I'm turning in. No at-grade street or trail  
25                  crossings, no pilings or retaining walls, no overhead

**Public Hearing - 6/17/2015**  
**Southwest Green Line LRT Extension**

1 power catenary, no traction power substations, no  
2 ongoing track and switch maintenance, no replacement of  
3 poorly-compacted soils, no relocation of freight rail,  
4 minimal utility relocations, almost no land  
5 acquisition, trivial wetlands impacts and mitigation,  
6 and minimal tree and brush removal.

7 It would take an hour to go through the  
8 presentation and PowerPoint. I can't do that; you're  
9 going to have to read the material.

10 Thank you.

11 MR. DUININCK: Thank you very much.

12 And the last person we have signed up so far  
13 is Frank Lorenz.

14 EP-06 MR. LORENZ: Frank Lorenz; I live in Edina,  
15 Minnesota.

16 I'm very much against light rail, in general,  
17 and the SWLRT, in particular. One of the hidden costs,  
18 regardless of whether you're going to be able to reduce  
19 costs by \$341 million or not is what's going to follow  
20 on as you start to make land acquisitions and actually  
21 build the project.

22 I've attended a number of hearings, both at  
23 the Metropolitan Council's committee meetings and at  
24 the Hennepin County Board meetings. And I've watched  
25 the biggest lawyers in town in their \$3,000 Italian

**Public Hearing - 6/17/2015**  
**Southwest Green Line LRT Extension**

1            silk suits waddle to the podium and make, essentially,  
2            the same statements, "Although my clients are not  
3            categorically opposed to the alignment," which means  
4            the route, "At this time, we reserve the right to" --  
5            and then they mumble something about a diminution of  
6            value because of noise, access to their property, or  
7            whatever, and then they sit down.

8                            They have set their hook. It's well-known  
9            that the wealthy, politically connected residents in  
10           the Kenilworth corridor don't want light rail, and they  
11           either are the biggest lawyers in town or have brunch  
12           with them every Sunday.

13                           So when you start to build this project,  
14           there are going to be two of the most powerful groups  
15           in the metro area with the deepest pockets, and they  
16           are going to sue Met Council. And they are going to  
17           win those lawsuits, and the residents in the Kenilworth  
18           area will be given awards of about \$300 million because  
19           their \$2 million houses will be worth only a million  
20           dollars.

21                           The other commercial property owners,  
22           apartment buildings, office buildings, retail  
23           buildings, will sue you for half a billion dollars, and  
24           they will win those lawsuits because the case law is  
25           perfectly clear. And so you can forget about the

**Public Hearing - 6/17/2015**  
**Southwest Green Line LRT Extension**

1           \$341 million problem that you say you have. Now,  
2           excuse me, there are no problems in elitist Minnesota;  
3           there are only challenges, so excuse me, the  
4           \$341 million challenge.

5                        When you get done with this a couple years  
6           later, you're going to be on the hook for \$800 million,  
7           and no penny of that will come from the federal  
8           government. They aren't going to share your mistakes.  
9           So the 900-pound gorilla at the end of the line,  
10          wherever that ends up being, is going to be these  
11          lawsuits. And you're going to lose them all, and then  
12          the taxpayers of Minnesota are going to have to pay  
13          every penny of this.

14                      The other thing is that people in north  
15          Minneapolis are being sold a complete bill of goods  
16          that there are these huge, unfilled numbers of jobs in  
17          Eden Prairie or the much-vaulted golden triangle, and  
18          if only they can get quick access from north  
19          Minneapolis to the western suburbs, their jobs problems  
20          will be solved.

21                      That's not true for two reasons: There is an  
22          outpost of more than 9,500 recent immigrants to  
23          Minnesota that live in supported housing in Eden  
24          Prairie. There's no shortage of unskilled labor or  
25          low-skilled labor in the area. The residents of

**Public Hearing - 6/17/2015**  
**Southwest Green Line LRT Extension**

1           Minneapolis-- North Minneapolis who unarguably need better  
2           jobs are not going to find them at the end of the line  
3           of SWLRT.

4                        So this is a -- this is a bad idea. You have  
5           a very good S -- Southwest bus system. You should use  
6           it; you should let them buy double decker buses which  
7           will cut the cost of operations in half. You should  
8           encourage them to run on the shoulders of the roads.

9                        But this is -- this is a project driven only  
10          by the greed and egos of the elitist people who run the  
11          unelected government called Met Council.

12                      MR. DUININCK: All right. Thank you,  
13          Mr. Lorenz.

14                      There are no others who have currently signed  
15          up, but in case anyone has joined us that is interested  
16          in testifying, I'll just open it up for a moment;  
17          otherwise, we will conclude our public hearing for the  
18          evening.

19                      Thanks, everyone, for being here. I think  
20          I'll just reiterate a couple points: One, thank you  
21          for your testimony. It all informs the public record  
22          which will be addressed in the final DEIS, hopefully,  
23          approximately a year from now, and if you have any  
24          other additional substantive comments, you can leave  
25          them via e-mail or via mail. We can provide you all

**Public Hearing - 6/17/2015**  
**Southwest Green Line LRT Extension**

1 with that information.

2 So thanks again for being here, and I'm sure  
3 those of us in the front room and the folks in the  
4 project office will stick around for a little bit. So  
5 thanks again for coming. Have a good night.

6 (Proceedings concluded at 6:32 p.m.)

7

8

9

10

11

12

13

14

15

16

17

18

19

20

21

22

23

24

25

**Public Hearing - 6/17/2015  
Southwest Green Line LRT Extension**

1 STATE OF MINNESOTA )  
 : ss CERTIFICATE  
2 COUNTY OF ANOKA )

3

4 BE IT KNOWN that I, Rebekah J. Bishop, took the  
foregoing transcript of proceedings;

5

6 That the foregoing transcript of proceedings is a  
true record of the testimony given;

7

That I am not related to any of the parties  
hereto, nor an employee of them, nor interested in the  
8 outcome of the action;

9 That the cost of the original has been charged to  
the party who noticed the transcript of proceedings, and  
10 that all parties who ordered copies have been charged at the  
same rate for such copies;

11

12 WITNESS MY HAND AND SEAL this 25th day of June,  
2015.

13

14

\_\_\_\_\_  
Rebekah J. Bishop, RPR, CRR  
Notary Public  
My Commission Expires 1/31/2020

15

16

17

18

19

20

21

22

23

24

25



Comment Card

From: Nancy Arieta

EPCC-02

SOUTHWEST

Green Line LRT Extension

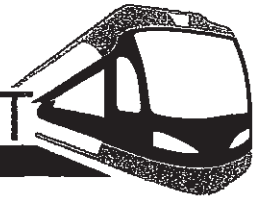

Date 6/17/15

Comment: I am against Light rail in Eden Prairie

my I know a person who chose not to live in a condo bldg because light rail <sup>is</sup> ~~was~~ right next to bldg.

See other side

vibration, noise, Traffic Tie ups

accidents, tear ups is permanent on roads cities

appreciate all your Tax payer paid jobs.

Is no different from streetcars.

Because Fed \$ are available does that force us to take it?

Our city does well with our wonderful bus SW Transit.

progress is not always bringing progress.

I am covering the SWLRT story, including the “Minnesota Media Establishment’s” role as de facto participants

I’m happy to report that on June 16<sup>th</sup>, **Finance and Commerce** became the first “Establishment” Minnesota media organization to report on the Legislatures action – their article had this headline (finance-commerce.com):

*Legislature takes back \$30M for Southwest LRT*

This is progress, but the story needs to be widely reported – Minnesotans have a right to know about this.

My web site, [www.bobagain.com](http://www.bobagain.com), has extensive reporting on this story – I invite you to visit it, and don’t hesitate to call or e-mail me. On youtube, my bobagain channel also has several videos.

**My own digging shows about \$90 million has been spent on SWLRT so far (way above the \$59 million widely reported). But the real issue is freezing spending on this project. Counties are set to spend \$67.3 million MORE – this year – unless we put the brakes on. Visit my web site for details.**



**The State cancelled \$30 million of SWLRT funding – even a shortened current alignment cannot be built**

As a registered lobbyist for “We the People” (an informal association), I promoted an agreement that is in the 2015 “Lights On” Transportation bill. About \$30 million of the \$37 million 2013 SWLRT appropriation was unspent, and was cancelled. That money was “repurposed” for Metro Council and Metro Transit operating costs.

Without that \$30 million the total State SWLRT appropriation is now about \$15 million. When I asked House Speaker Kurt Daubt at the Special Session if the House might make money available for SWLRT in 2016, he said “no”. The SDEIS says (section 5.2) “... remaining funding is assumed to come from... the State (10 percent)...” The Metro Council’s plan assumes \$1.65 billion will be available. But with \$150 million of State money gone, the money available drops by \$300 million (\$150 million in Federal \$’s is also gone). With \$1.35 billion now available, the current alignment is dead.

# ***PRT Minnesota, Inc.***

11330 86th Ave N • Maple Grove MN 55369  
612-247-6685 • jlampe@prt-mn.com

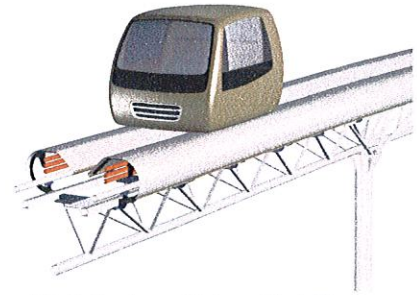

*21st Century Urban Mobility*

June 17, 2015

***COPY***

Nancy Tyra-Lukens, Mayor  
City of Eden Prairie  
8080 Mitchell Rd  
Eden Prairie, MN 55344

Dear Mayor,

This letter is addressed to you in your capacity as a member of the Southwest LRT Corridor Management Committee. Recent mandated cuts in the cost of the SW line have caught my attention, and last month I began to study the options. I have seen your written comments submitted to the Corridor Management Committee on June 3 and I am very sympathetic to the concerns and problems you raised. I am committed to solving them.

On Sunday June 7 I took a vehicle tour of Eden Prairie to examine the potential for a low cost "range extender system" if SW LRT terminates at the Golden Triangle station, which I am making the case for. Bear with me . . .

A little background -- I am a transit enthusiast. When I lived in Washington DC my mobility was primarily walking and the DC Metro. Daily transit trip share in the Twin Cities is only 3% of the 12 million daily trips by all modes. We can do better. My personal goal for the Twin Cities is 20% transit trip share by 2040.

The more I investigate the SW LRT budget cuts the more interesting it gets. I appreciate that the Corridor Management Committee currently opposes ending the line at Golden Triangle. According to the June 3 staff presentation to the Committee, the cost savings of ending it there would be \$52 to \$59 million more than the cost reduction goal of \$341 million. Additionally, other proposed cost reductions in the LRT line would be unnecessary, thereby gaining allies in the affected cities.

The savings would pay for more than half of a Personal Rapid Transit range extender system beyond the Golden Triangle. Because there would be 12 additional stations over a large area, LRT ridership would increase well beyond the original estimates. This increased ridership will improve the SW project's Cost Effectiveness Index with the FTA. To achieve high ridership, transit station walk distances should be no more than 1/4 mile. PRT stations are close together, resulting in very short walk distances.

PRT Minnesota can build a 10.7 mile Personal Rapid Transit range extender and local circulator system for about \$10 million per connectivity mile. A conceptual map of such a system is enclosed. I have provided an earlier version of it to Randy Newton in the Public Works Department for staff to discuss.



Enclosed is a short presentation on PRT made last week to the Brooklyn Park Rotary. A collection of PRT videos is at <http://www.prtconsulting.com/prtvendorvideos.html> A video animation is at <http://www.gettherefast.org/bettercampus.html> A pro and con overview is at [http://en.wikipedia.org/wiki/Personal\\_rapid\\_transit](http://en.wikipedia.org/wiki/Personal_rapid_transit) All of these items are on the enclosed DVD.

PRT technology has advanced dramatically in recent years, in great measure because of lessons learned from the deployment of four systems in other countries during the past five years. We have designed a world-class 4th generation PRT technology. Our technology is beyond the research phase, and significant engineering development has been completed. About \$20 million is needed to bring the system to manufacturing and deployment readiness. Engineering innovations from our California-based control system provider and from Ingmar Andreasson in Sweden allow peak traffic period throughput of 14,400 persons per hour, using paired 3-person vehicles at 1.5 sec headways. Ingmar's presentation at the Podcar City 8 conference is available at [https://www.youtube.com/watch?v=RI\\_2YgS9JXg](https://www.youtube.com/watch?v=RI_2YgS9JXg) and is on the enclosed DVD. A paper copy of Ingmar's PowerPoint presentation is enclosed.

The partnership of PRT Minnesota and Transit Control Solutions (TCS) has designed a PRT system with 60 MPH speeds and one second intervals between vehicles. Trip times and wait times for the PRT system will be much shorter than trips on current transit systems. Urban travel by PRT will be time and cost competitive with travel by automobile.

The TCS vehicle control system is the world's most advanced Communications Based Train Control, based on their Dynamic Block Control (DBC) technology. The TCS founder, Eugene Nishinaga, has a patent for the DBC technology, with ten more to follow. He had 37 years of employment in the transit industry, most of it with BART, followed by eight years of R&D on PRT and train control technology.

Our physical design and control technology is driving down the cost and vastly increasing the performance of PRT relative to recent systems built in other countries by Ultra, Vectus, 2GetThere and ModuTram. A major reason for skepticism of PRT by public transit agencies is that the Morgantown WV PRT and the newer PRT systems are relatively low speed and low capacity. There are no PRT designs in the US or elsewhere with the advanced functionality that the PRT Minnesota design has. Our guideway and vehicle concepts were greatly influenced by a world famous roller coaster designer.

PRT has been trapped in a loop for decades:

- The customer (such as Eden Prairie) needs a product
- The product development needs an investor (about \$20 million)
- The investor needs a customer

But we are getting close to breaking out of this loop, and Eden Prairie may be part of the solution. The city has the most ideal structure for PRT that we have found in the USA.

Historically PRT has been rejected because of its perceived low speeds and low capacity and the lack of real-world deployments. Our control, vehicle and guideway technologies solve the speed, capacity and cost issues. PRT is a proven technology, with five automated systems now operating in five countries. Driverless automated vehicles are rapidly joining

the transportation world. Rivium in the Netherlands even has a driverless automated bus system, called Park Shuttle, in operation since 2008:

<http://www.advancedtransit.org/advanced-transit/applications/rivium/>

Self-driving vehicles require control technology at least 10X more complex than PRT control, but it is being done and therefore PRT control can be done.

The low capital and operating costs of PRT, coupled with very high capacity and short trip times, means that public agencies can build PRT systems for a fraction of the cost of current transit, while achieving high ridership and reaching deep into low density suburban areas. Fare box revenues can pay the construction or operating costs. Federal government money is not needed.

Because of slow and inconvenient service compared to automobiles, transit in the US carries only 1 to 2 percent of all urban daily trips. Only six US cities have transit trip share above four percent. In our metro area daily trip share is 3%. To have a large share of daily trips, transit has to "go everywhere all the time, with automobile competitive travel time." Buses have large networks, but trip times are too long and rail has too few destinations as well as long trip times.

Transit mode share is determined by walk time, wait time, ride time, transfer time, fare, number of origins and destinations, plus other criteria like health status, age, weather and "can you afford to own and operate a car?" Total trip time is the most important factor. Current transit technology is not automobile competitive, so few people use it unless they absolutely have to. Because current transit is not a workable travel mode for most people, they drive cars. But traffic congestion continues to increase. The number of vehicle miles traveled each year increases much faster than lane miles of roads. Buses can't attract riders and there is not enough money and land to build sufficient roads and urban rail systems.

High performance PRT is the only urban travel mode that can overcome these limitations and problems. It can be built and operated at low cost relative to other modes, and can provide high capacity, large numbers of origin destination pairs and short trip times, thereby attracting riders. It is time to demonstrate these characteristics in an environment where it is complementing rather than competing with rail transit.

The decision process on SW LRT is moving rapidly and I would like to meet with you to discuss a path forward to building a world-class transit system for Eden Prairie that will complement the SW Corridor project.

Sincerely yours.

A handwritten signature in black ink that reads "Joseph Lampe". The signature is written in a cursive, flowing style.

Joseph Lampe, President  
PRT Minnesota, Inc.

cc: City Council  
Corridor Management Committee



# Range Extender for SW LRT

3.6 LRT route miles      9.6 PRT route miles

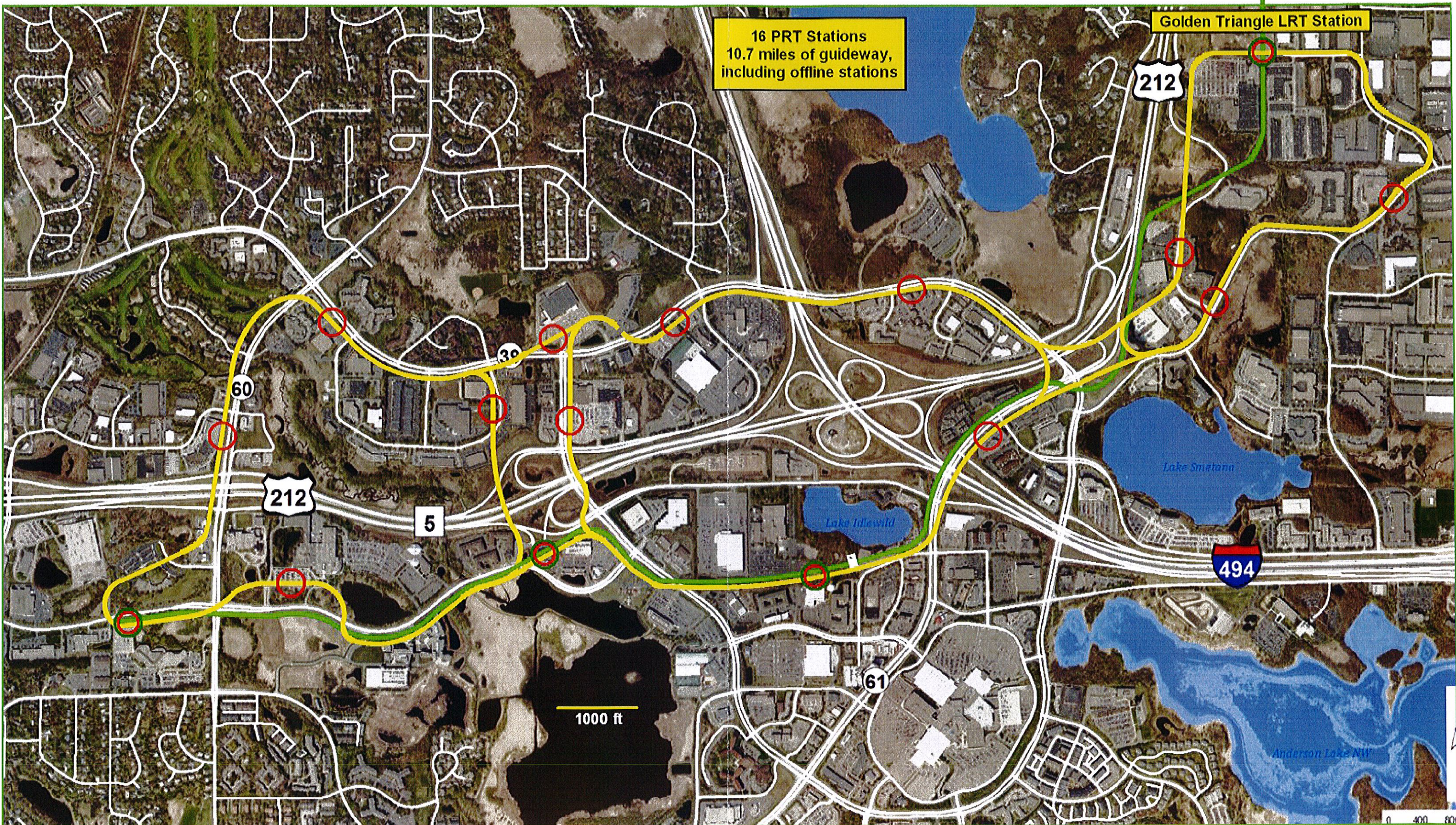

16 PRT Stations  
10.7 miles of guideway,  
including offline stations

Golden Triangle LRT Station

212

60

212

5

39

61

494

1000 ft

Lake Smitana

Lake Illsworth

Anderson Lake NW

0 400 800



## Appendix

### **PRT Simplifies Transit Planning, Construction and Operations:**

No vibration or acoustic noise emission.

No buried cable ducts -- communication links are in the guideway.

No at-grade street crossings.

No pilings or retaining walls

No overhead power catenary.

No large and expensive traction transformer-rectifier substations.

No ongoing track and switch maintenance

No replacement of poorly compacted soils

No relocation or abandonment of freight rail.

No "capital maintenance" funding requests to Legislature

Minimal utility relocations (at Heathrow there were zero).

Simple 13.8KV 3-phase power feed to 480V transformers.

Almost no land acquisition required (need only 50-year easements).

Trivial wetlands impacts and mitigation, thus greatly simplified and less expensive EIS.

Most of the system can be installed on existing public right-of-way.

3-berth stations can have a footprint as small as 19 ft x 38 ft (4 parking stalls)

Each additional loading berth adds about 9 ft to the length.

Rapid construction and installation.

Much smaller OMF building and yards.

Greatly reduced OMF staffing requirements.

Extreme flexibility and simplicity of system layout and station locations.

Near immunity to severe winter weather conditions.

Complete automation means lower operating costs.

Curve radii as small as 75 ft.

Vehicles can climb 10% grade.

etc.

etc.

etc.

**A few of the many PRT resources on the Internet:**

<http://www.ilsr.org/really-light-rail/>

StarTribune article by David Morris - Institute for Local Self Reliance

<http://gettherefast.org/bettercampus.html> (click on the video icon)

<http://youtube.com/watch?v=B7hgipbl1BK8>

collection of 20 ULTra videos - PRT at Heathrow

<http://www.advancedtransit.org/advanced-transit/applications/rivium/>

driverless automated bus system in the Netherlands

[http://www.en.wikipedia.org/wiki/Personal\\_rapid\\_transit](http://www.en.wikipedia.org/wiki/Personal_rapid_transit)

pro and con overview (somewhat out-of-date)

<http://hbswk.edu/item/6333.html>

commentary from Harvard Business School

[http://faculty.washington.edu/jbs/itrans/planetizen\\_article.htm](http://faculty.washington.edu/jbs/itrans/planetizen_article.htm)

[http://faculty.washington.edu/jbs/itrans/big/Goran\\_shortfalls.pdf](http://faculty.washington.edu/jbs/itrans/big/Goran_shortfalls.pdf)

[https://www.youtube.com/watch?v=RI\\_2YgS9JXg](https://www.youtube.com/watch?v=RI_2YgS9JXg)

Ingmar Andreasson - PRT as mass transit

<http://www.prtconsulting.com/content.html>

PRT resource site

<http://www.prtconsulting.com/prtvendorvideos.html>

assorted videos of driverless transit systems

<http://faculty.washington.edu/jbs/itrans/burke.htm>

*Innovation and Public Policy: The Case of Personal Rapid Transit* - book

<http://www.open-spaces.com/article-v3n2-bundy.php>

analysis of transit by a Seattle environmentalist

<http://www.containerstory.com>

how the standardized container industry revolutionized shipping  
(history lesson on technological innovation)



## PERSONAL RAPID TRANSIT (PRT)

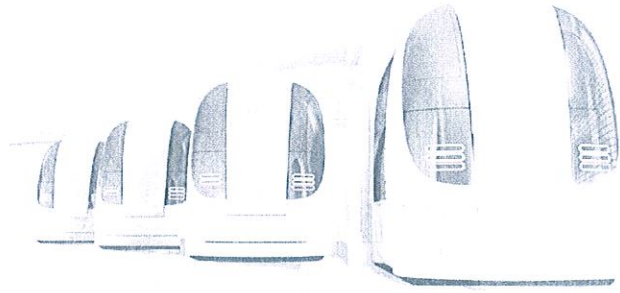

*Urban Mobility for the 21<sup>st</sup> Century*

June 16, 2015

"The Americans have need of the telephone, but we do not. We have plenty of messenger boys."  
- Sir William Preece, Chief Engineer, British Post Office, 1878



"The idea that cavalry will be replaced by these iron coaches is absurd. It is little short of treasonous."  
- Comment of Aide-de-camp to Field Marshal Haig,  
at tank demonstration, 1916



"How, sir, would you make a ship sail against the wind and currents by lighting a bonfire under her deck? I pray you, excuse me, I have not the time to listen to such nonsense." - Napoleon Bonaparte, when told of Robert Fulton's steamboat, 1800s

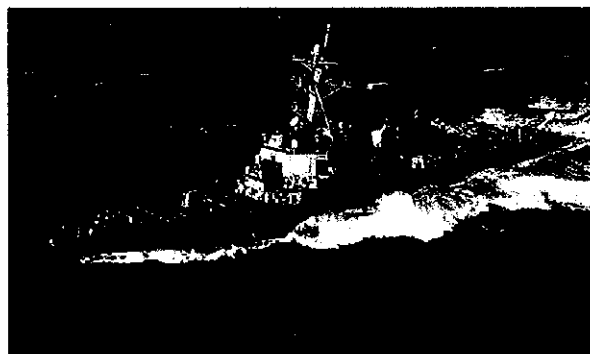

"No one will pay good money to get from Berlin to Potsdam in one hour when he can ride his horse there in one day for free." - King William I of Prussia, on trains, 1864

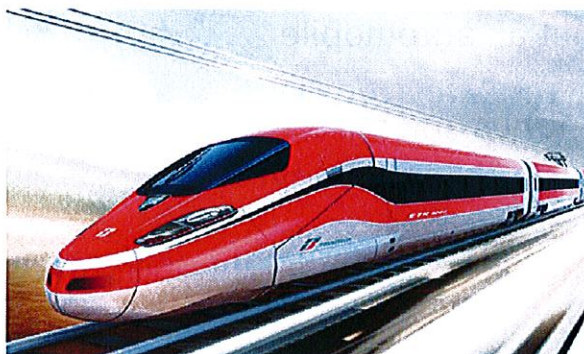

## The Problem

- Increasing traffic congestion & travel delays
- Vehicle Miles Traveled increase much faster than Lane Miles Built
- Taxpayers oppose fuel taxes to build more roads
- Current transit is unworkable for most urban trips
- Only six US cities are above 4% transit trip share
- Most US cities are at 1-2% transit trip share

## More Problems

- Increasing need for urban mobility without an automobile
- Current bus and rail technology can't improve urban mobility
- 60-year backlog of federal transit funding requests

## The Solution is Personal Rapid Transit ( *ULtra-Light Rail* )

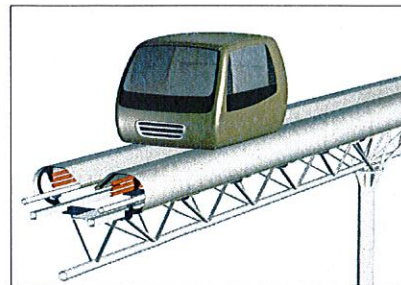



## Morgantown, WV - 1975

8.7 mile system  
20 passenger vehicles  
Cost \$130 million

Still operating in 2015  
No accidents in 40 years



## PRT Technology Maturation

PRT has an extended R&D history  
Now has entered the Early Adopter stage

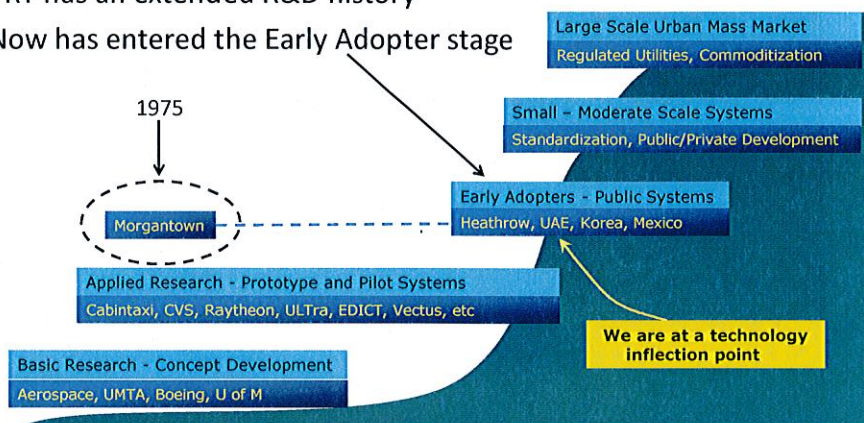

Booz | Allen | Hamilton

PRT for the Microsoft Campus  
( *extending the range of rail transit* )

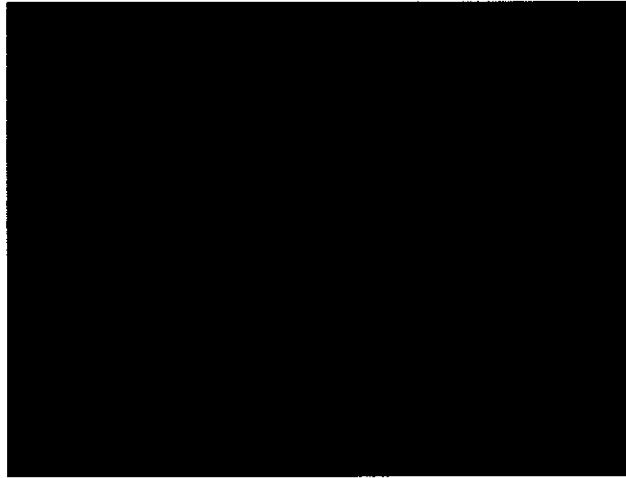

Recent Automated Transit  
( *no sound track* )

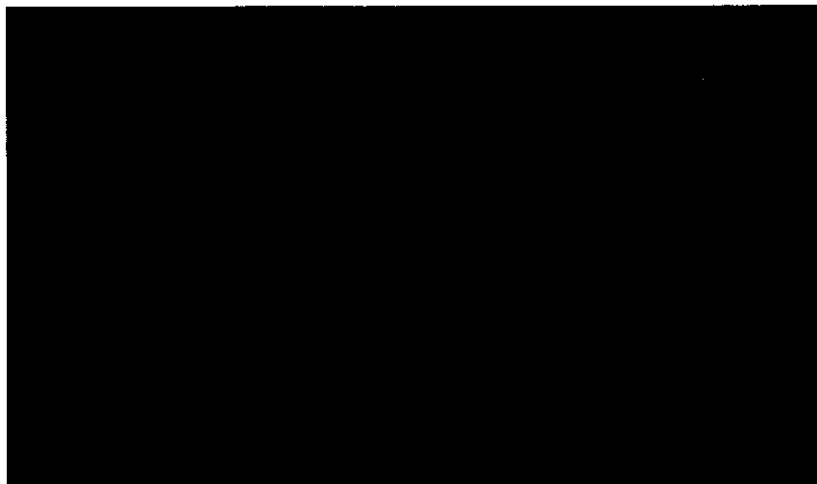

## PRT Urban Integration

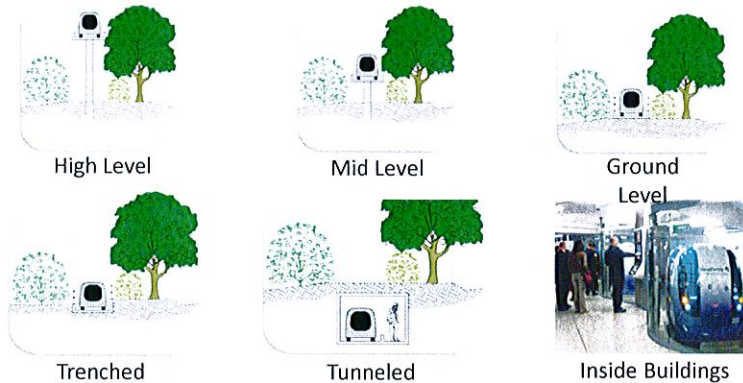

Can be attached to sides of buildings and bridges

## Why So Few Transit Riders?

- Rail and buses have long trip times
- Rail has very few stations
- Rail is very expensive and intrusive, so large networks cannot be built
- Transit is inconvenient for most urban trips
  - *walk time, wait time, trip time, transfers, weather*

## Why PRT Has High Ridership

- Many stations, closely spaced
- Short trip times, travel up to 60 MPH
- The high capacity of rail transit
- Private, safe, secure and seated ride
- On-demand service, no waiting at stations
- Trips are direct to destination, no stops or transfers
- All weather, available 24x7, handicapped accessible
- Efficiently serves lower population density areas

## Cost/Benefit Analysis

- PRT has Low Capital Costs:  
about 10% of LRT per connectivity mile
- PRT has Low Operating Costs:  
50% of LRT and bus transit
- The PRT MN design has High Capacity  
and Short Trip Times
- Life-Cycle Cost per passenger mile is low



## Benefits to Communities

- Flexible, non-intrusive design
- Simple route planning and urban integration
- Network and corridor layouts are feasible
- Energy efficient – equivalent to 80 MPG auto
- Able to climb and descend 10% grades
- No need for Federal transit funding
- Reduced transit operating subsidies

## Benefits to Transit Agencies and Government

- Increased transit accessibility and use
- Reduced need for road expansion
- Low construction costs
- Low operating costs
- No need for federal funding to build systems

## Data from Minneapolis/St. Paul

- Five LRT lines will cost \$6 billion, but in 2030 they will provide only 1.3% of all daily trips
- In 2030 buses will provide only 3% of all daily trips in Minneapolis/St. Paul
- 100% of public transit capital costs and 70% of operating costs are financed by taxes

## PRT for Eden Prairie

### Range Extender for SW LRT

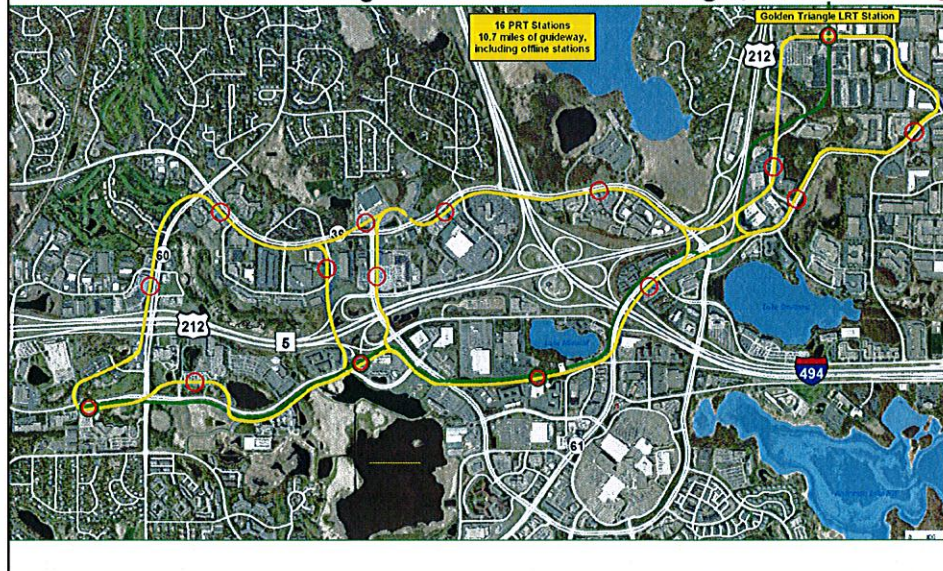

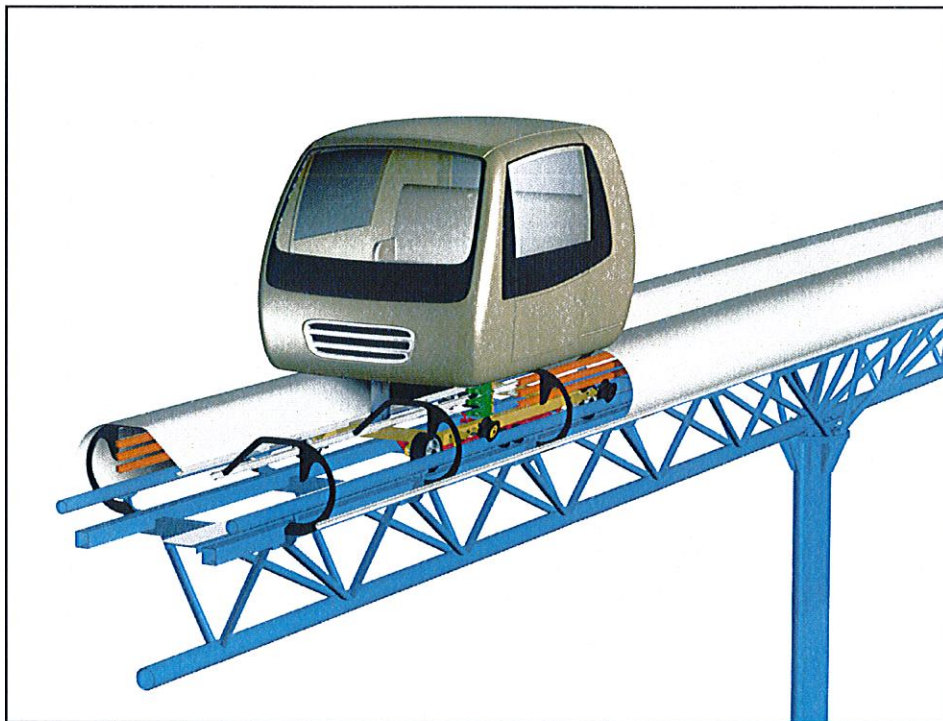
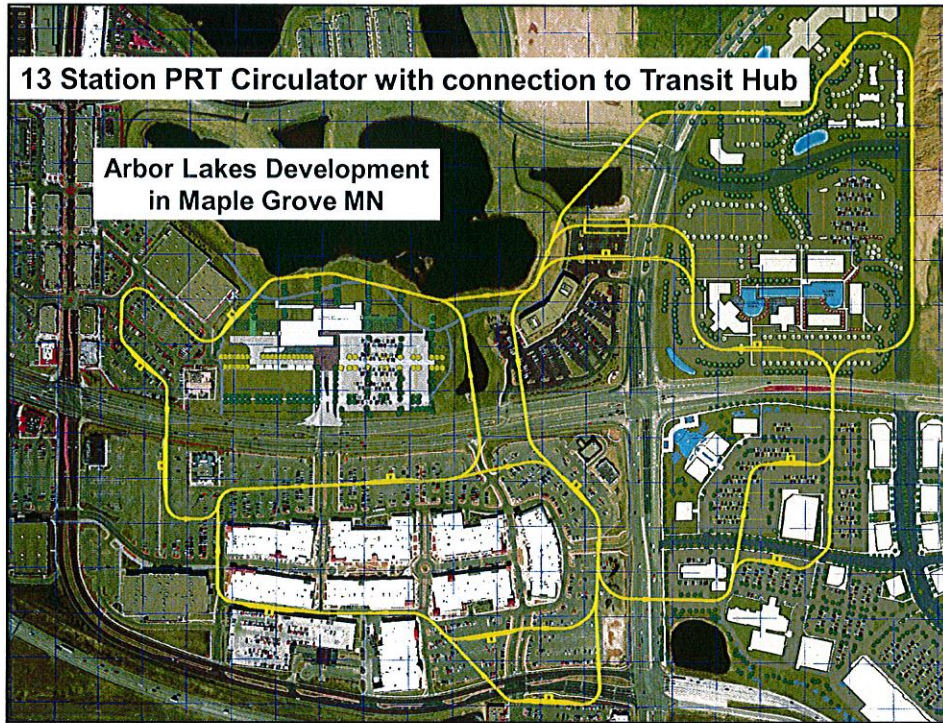



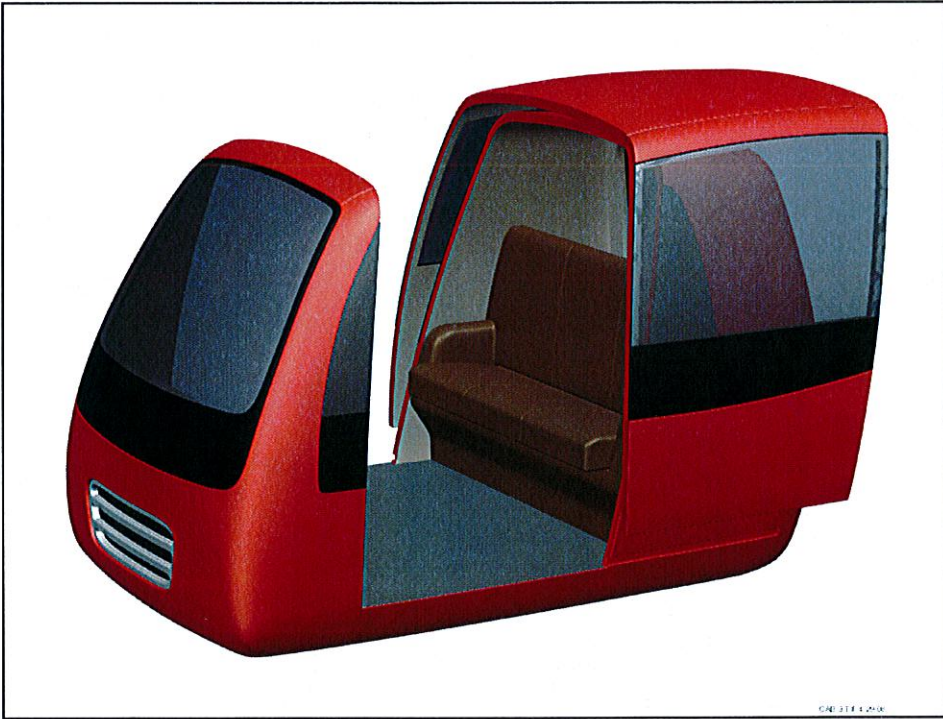
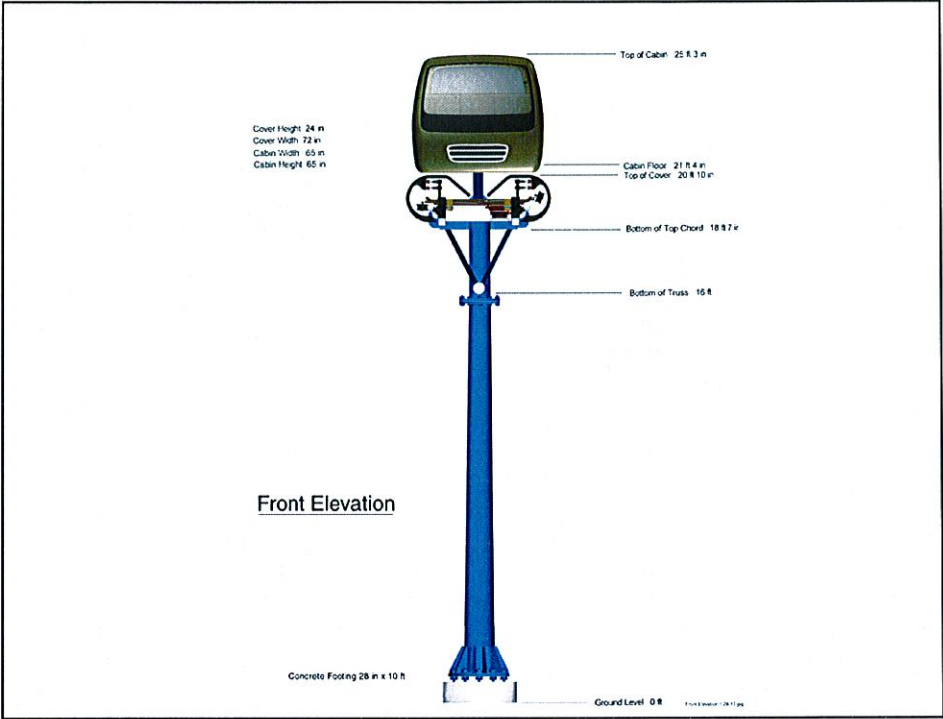

## Target Markets and Customers

- Public transit agencies ultimately will be the largest purchasers
- 250 US cities that cannot afford to build conventional rail transit
- Collector/distributor for rail stations
- Corporate campuses
- Amusement parks
- Shopping districts
- **Global market is 10 X larger than US market**

## Contact Information

- Joseph Lampe, President  
PRT Minnesota, Inc.  
612-247-6685  
[jlampe@prt-mn.com](mailto:jlampe@prt-mn.com)
- Thomas Hokr  
PRT Minnesota, Inc.  
612-840-0790  
[thokr@mhscos.com](mailto:thokr@mhscos.com)



# From personal to mass transit

Prof. em. Ingmar Andreasson

[ingmar@logistikcentrum.se](mailto:ingmar@logistikcentrum.se)

# 40 years in transportation

- Transit network planning - VIPS
- Taxi fleet management - Taxi80
- Multi-discipline PRT research - Chalmers
- Road traffic research – KTH
- 5 PRT patents
- VP, Advanced Transit Association

# Storyline

- A challenging podcar application
- Five strategies to cope with large demand
- => Mass transit with podcars





# The challenge

- Dense urban area in California
- Very large employers
- Severe highway congestion
- Promote non-car modes
- Transfers from Train and LRT
- Connecting buildings (horizontal elevator)

Contract with PRTCconsulting

Legend

Station	
28 mph main guideway	
22 mph main guideway	



ONE MILE

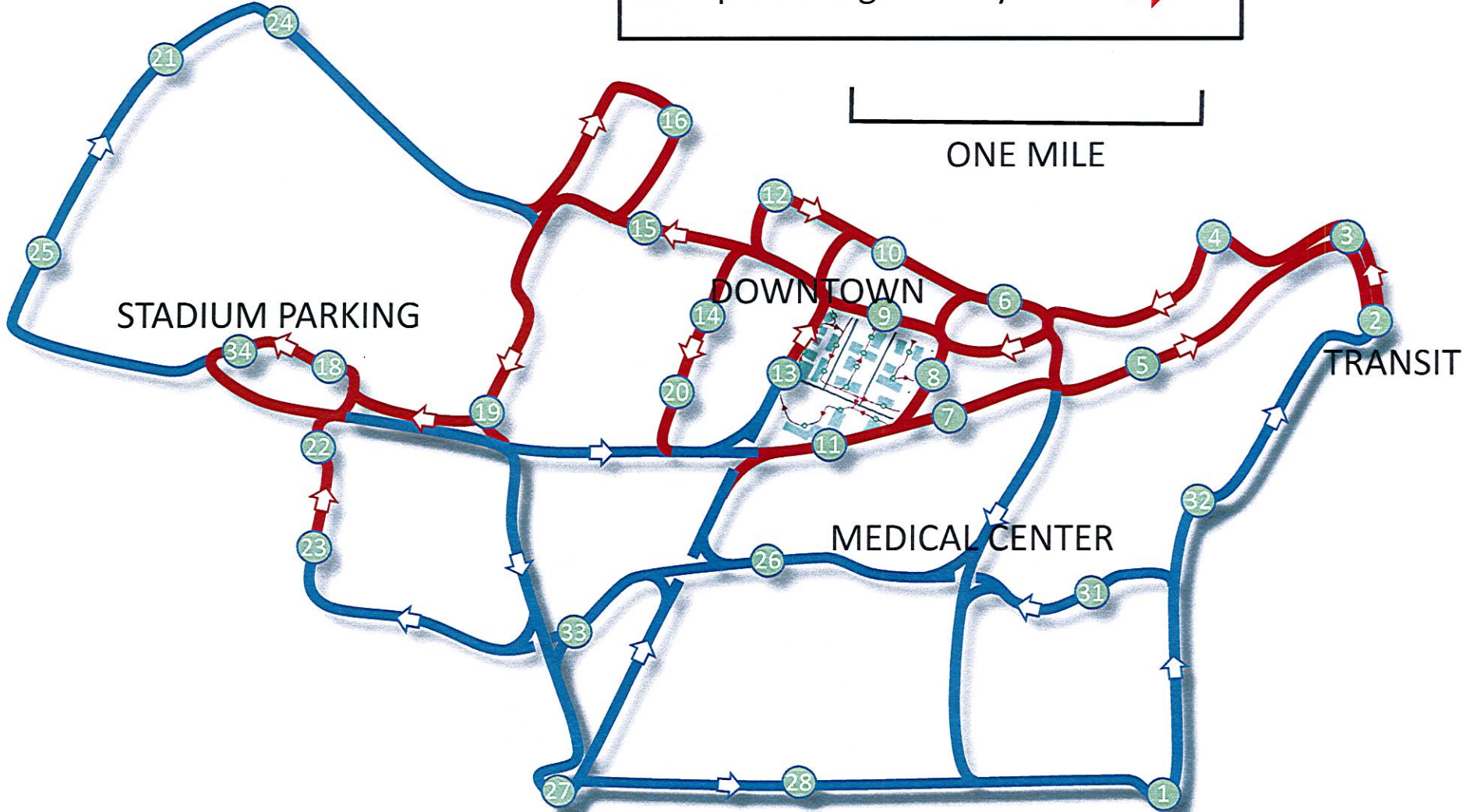

RAIL STATION



### Legend

Station

28 mph main guideway

22 mph main guideway

22 mph feeder guideway  
(with slowing at stations)

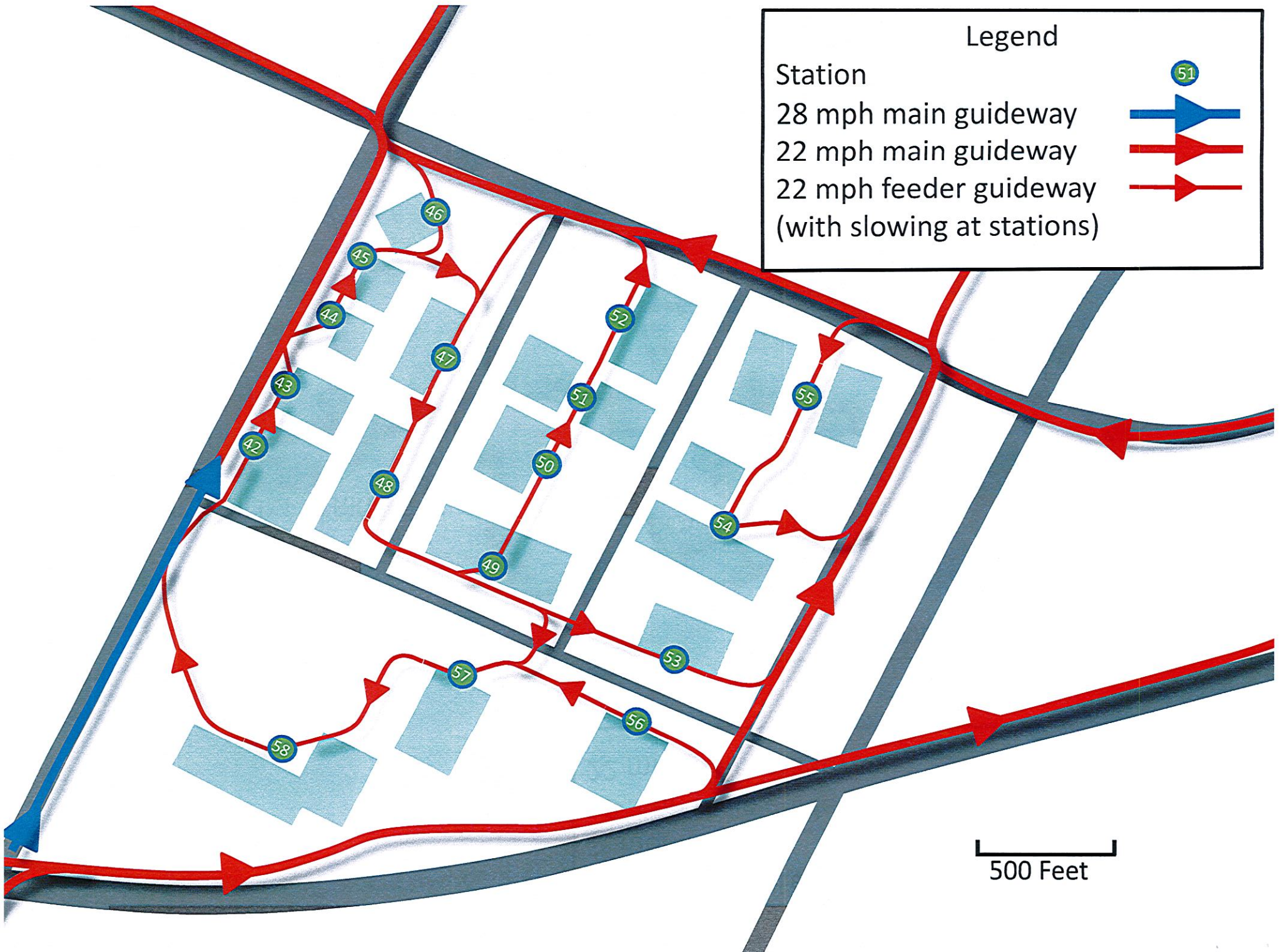
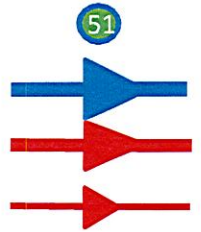

500 Feet

# Our tentative design

- 50 stations
- 48 kms main guideway (6 % double)
- 4 bi-level intersections out of 54
- Speeds 36 and 45 kph
- Headway 3 secs (as certified)
- 900 vehicles with 6-seats

# Morning peak hour demand

- 13 000 passengers
- 30 % of trips from 3 transfer stations
- 400 passengers from one train
- Many dispersed destinations



# Train / PRT station

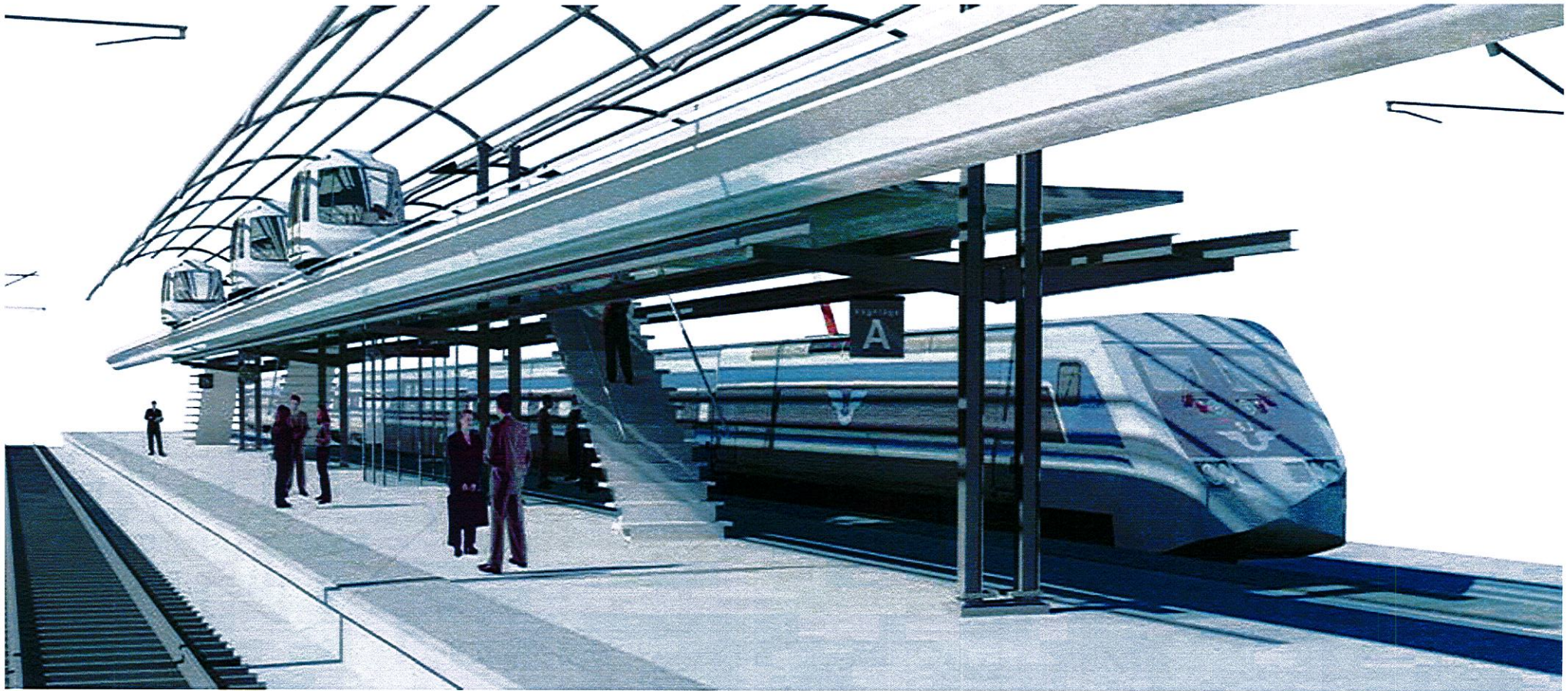



Morning peak demand 13 000 / h

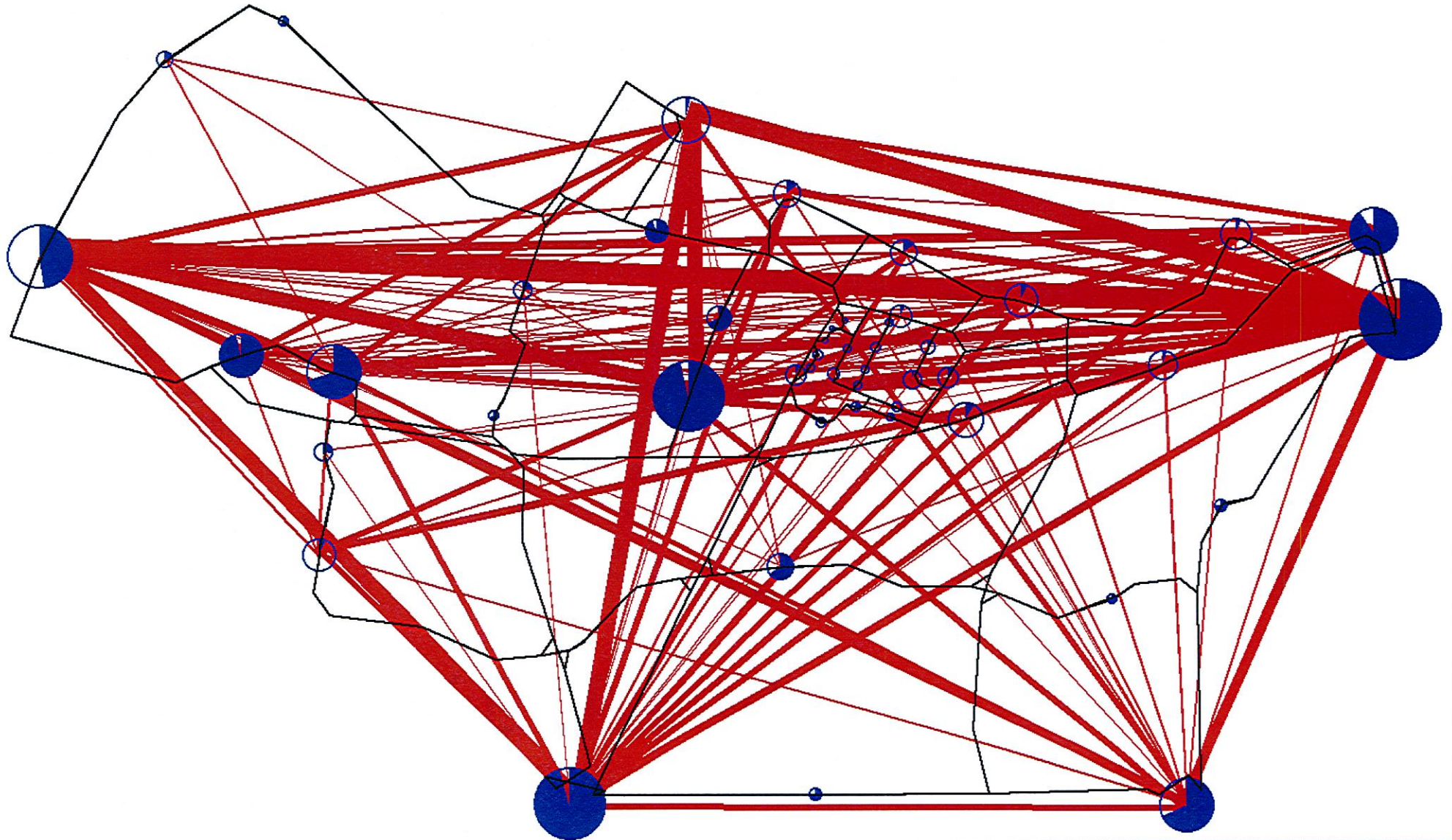

# Personal Rapid Transit

- Average 1.5 passengers per vehicle
- Can carry 4 800 passengers
- 24 mins waiting



# Ride-matching at departure

- System knows requested destinations
- First passenger determines destination
- Destination sign over vehicle
- System assigns vehicle when enough load (5 of 6)
- ...or after max holding (1 min)

# Ride-sharing morning

- In relations with  $>1$  party per minute
- 7 % of relations have 60 % of all trips
- 48 % of passengers matched
- Average load 3.9 passengers
- 11 400 passengers carried
- 11 minutes waiting

# Evening peak most challenging

- Many small origins
- Less opportunities for matching
- 43 % of passengers matched (48)
- 10 800 passengers carried (11 400)

# Standing passengers?

- Vehicle for 6 seated + 6 standing
- Limited braking => double headway
- Same capacity
- Longer station ramps

# Same capacity without standees

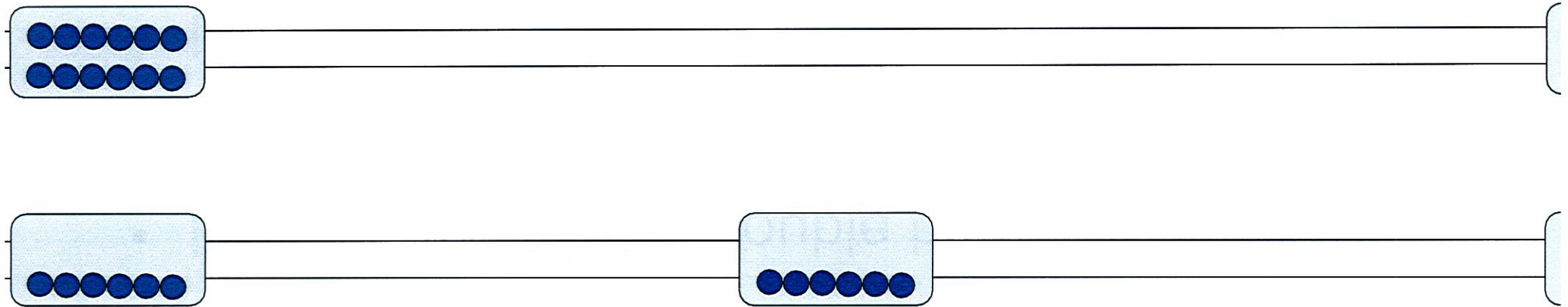

# Coupled vehicles

- Coupled in station
- Decouple in switches to different destinations
- Safe distance between couples
- 2 x line capacity at departure
- Average 1.5 en route



# Vehicle pair can safely split apart



- Can serve different destinations
- More load with two destinations
- Each vehicle goes non-stop

# Larger vehicle?

- 24 passengers including standees
- 6 sec headway
- Couple 2 x 6 seated has same capacity
- ...and can split up en route



# Coupled vehicles better than big

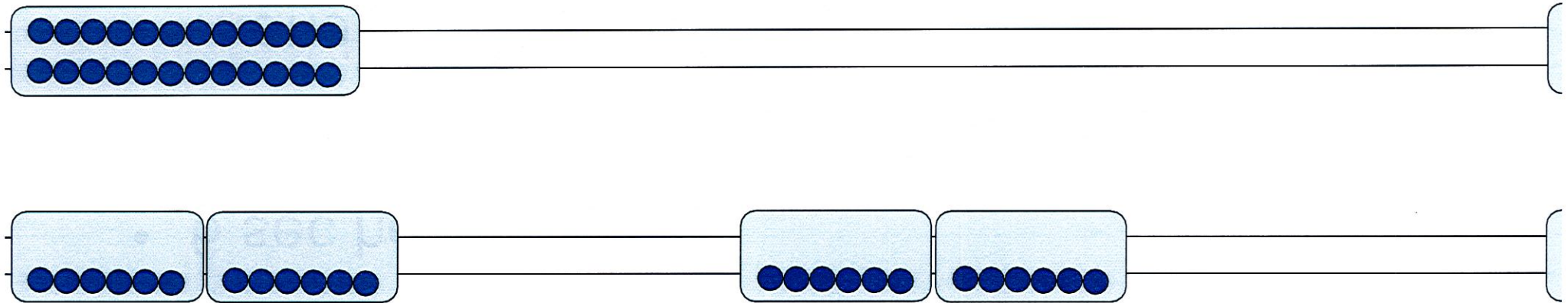

- Can serve 4 destinations

# Electronic or mechanical coupling



# Ride-sharing plus coupling

- 13 200 passengers carried evening (10 800)
- 5 mins waiting (11)
- Better – but still too much waiting

# Sharing to 2 destinations

- 26 % of departures for 2 destinations
- 58 % of passengers matched (48)
- 13 300 passengers carried
- 3.5 mins waiting (5)



# Second destination before or after

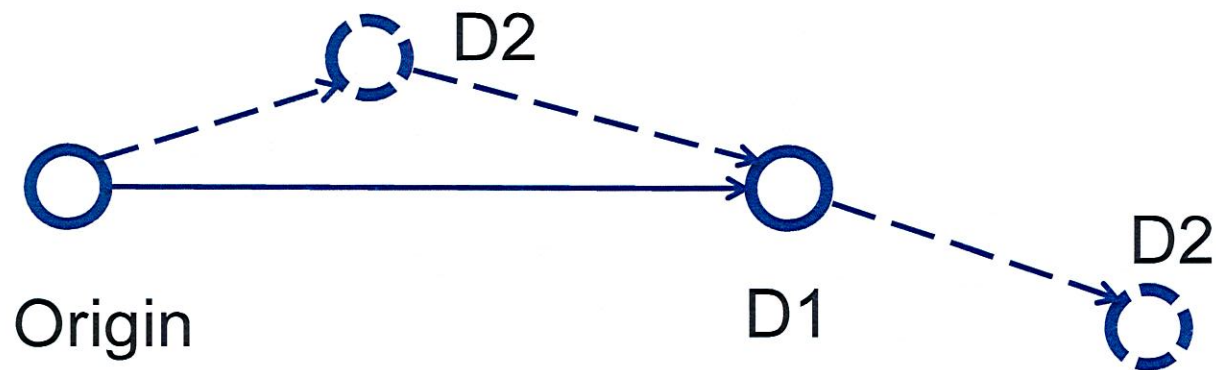

- Detours within 20 %

# Allow boarding to same destination

- When stopped to drop off
- Waiting passengers to same destination
- Destination sign over vehicle
- No reason not to allow boarding

# Ride-sharing patterns



Same O & same D



Two destinations



Allow boarding

# Sharing to 3 destinations

- 59 % of passengers matched
- 1.2 destinations average
- 13 400 passengers carried
- 3.3 mins waiting (3.5)



# Adding a third destination

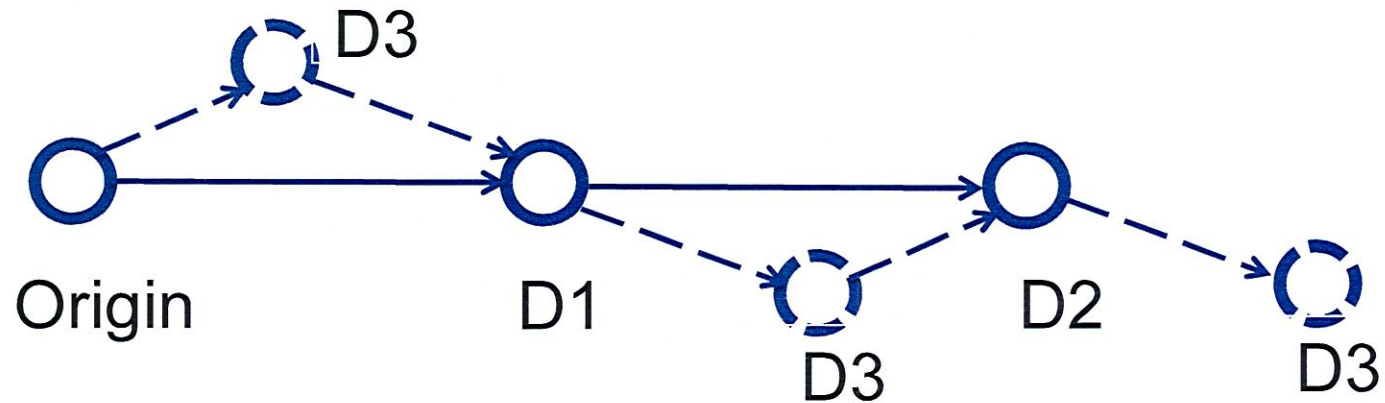

- Before, between or after

# Matching many-to-few

- Evening demands more difficult to match
- Multiple pick-ups to common destination (transfer)
- First passengers determine destinations and route
- Stopping en route to pick up for same destinations

# Stop en route to pick up

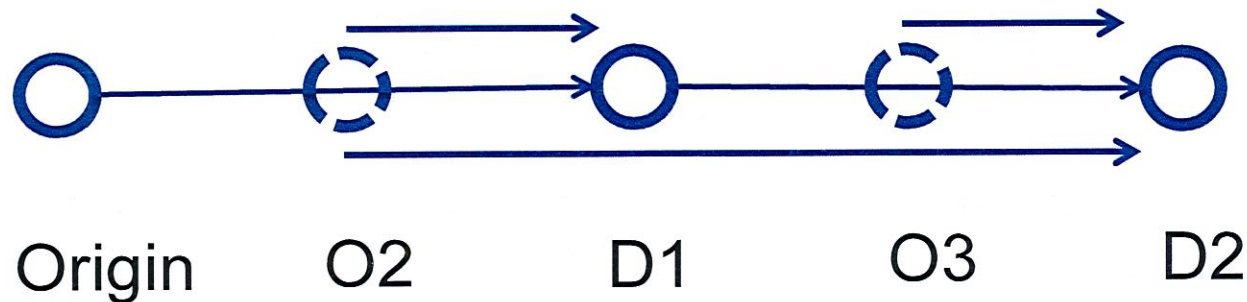

- Route fixed to one or two destinations
- Check waiting passengers en route
- Pick up for same destinations
- No passenger makes more than two extra stops

# Stop to pick up

- Picking up 2 000 passengers out of 13 400
- 0.3 intermediate stops per passenger
- 4.5 passengers per vehicle (3.9)
- All vehicles full (6) on max link
- 2.9 mins wait (3.1)
- +10 % ride time



# Ride-sharing patterns

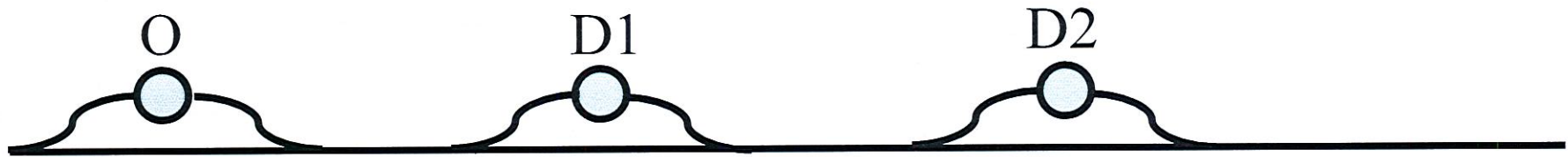

Same origin & destin



Two destinations



Allow boarding







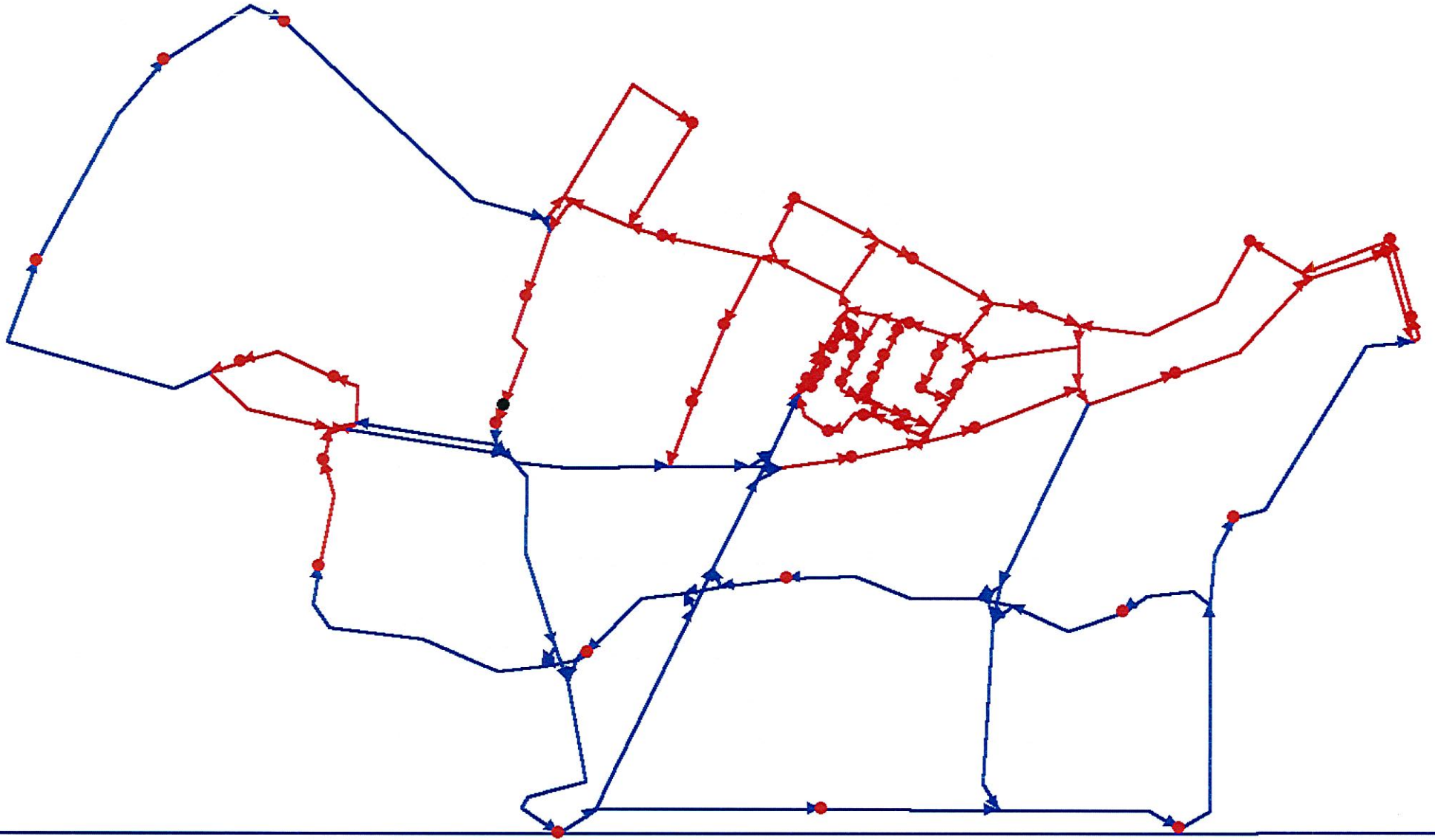

Stop to pick en route

# Network high/low speed + train



# Animation 10 x real speed

-  Empty vehicle
-  1 passenger
-  2
-  3
-  4 or more
-  Load/unload
-  Couple

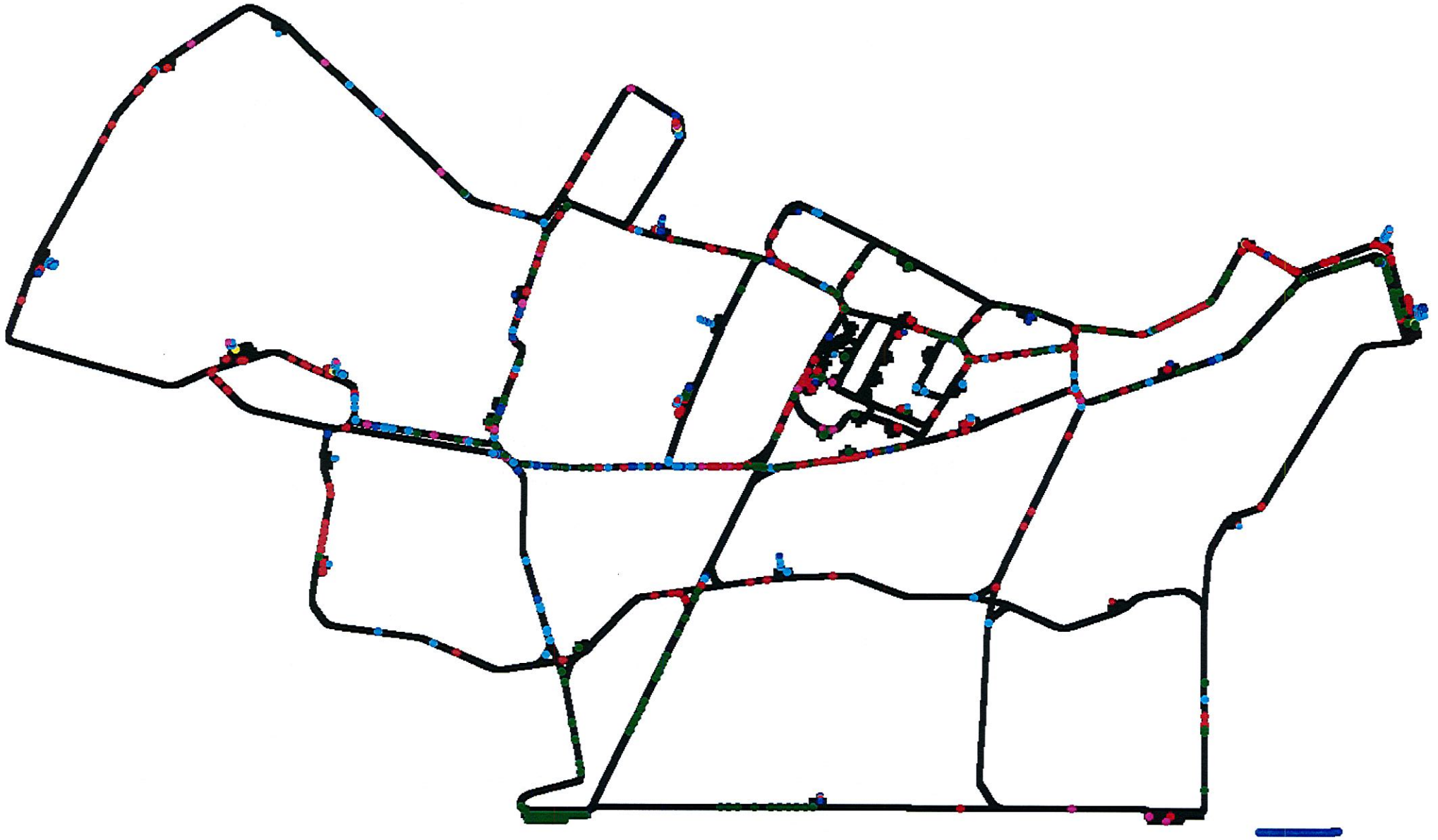



13 400 trips evening peak (6 000 link)

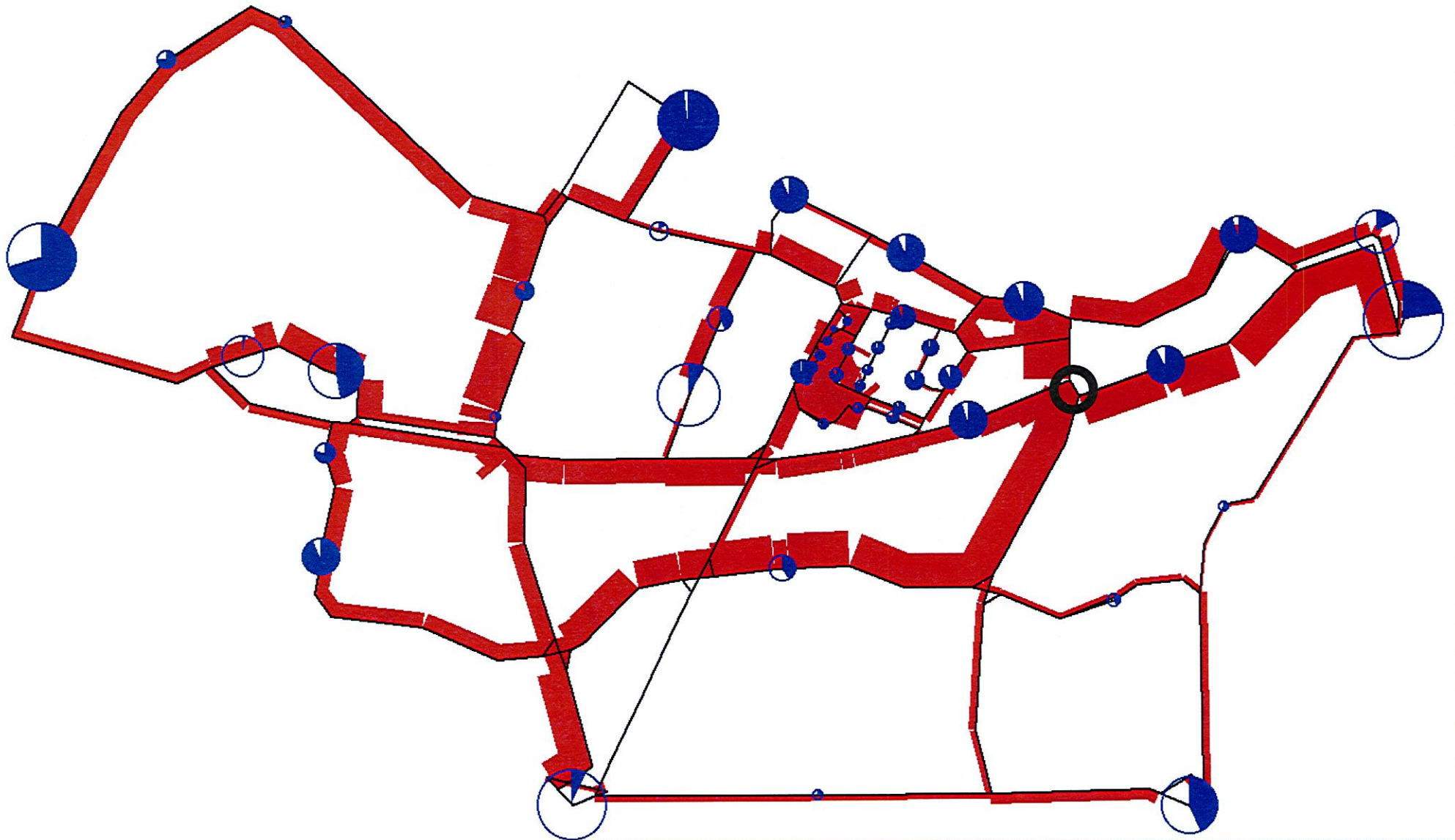

910 vehicles (1800 vph on link)

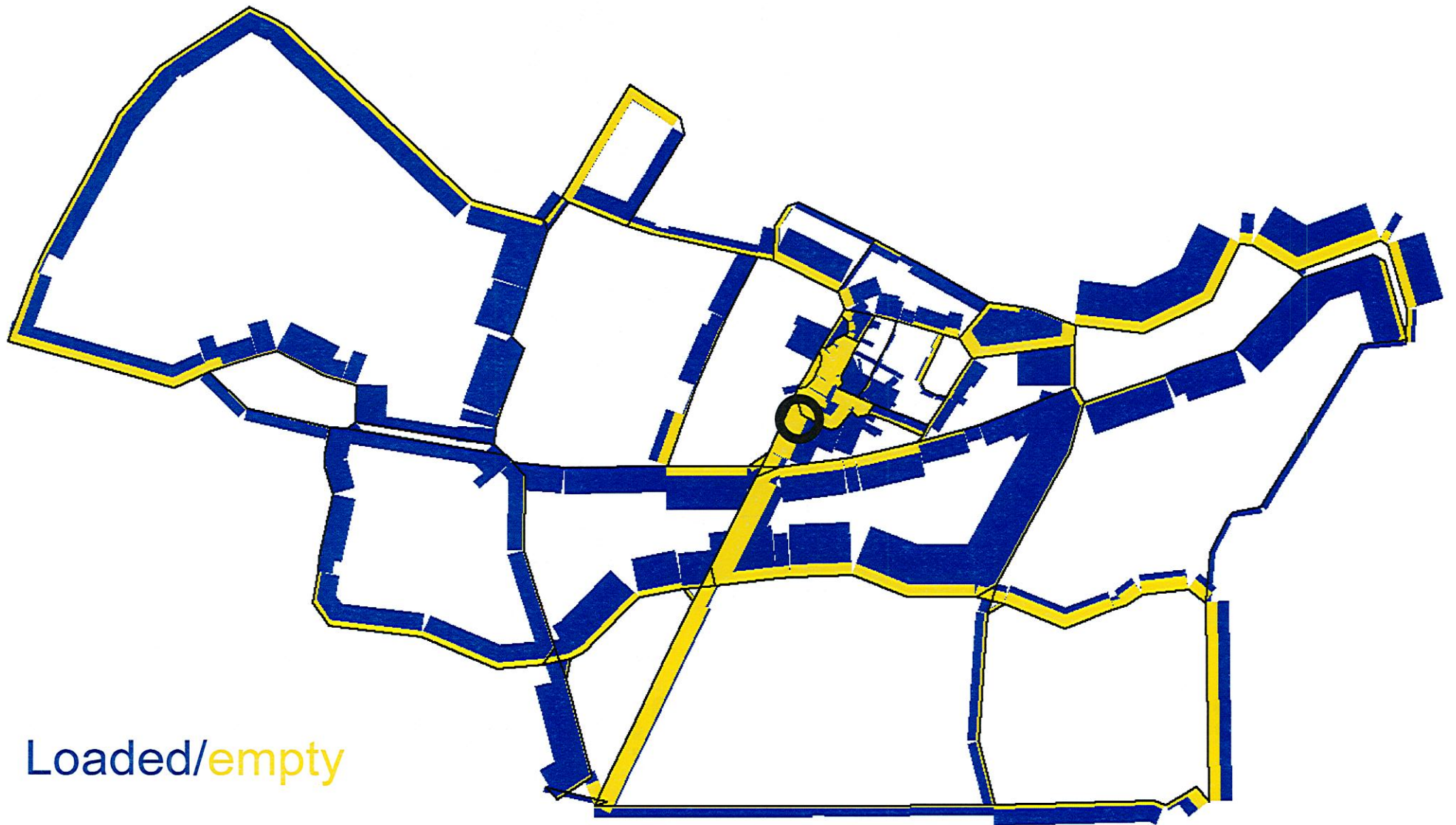

# Less waiting with more ride-sharing

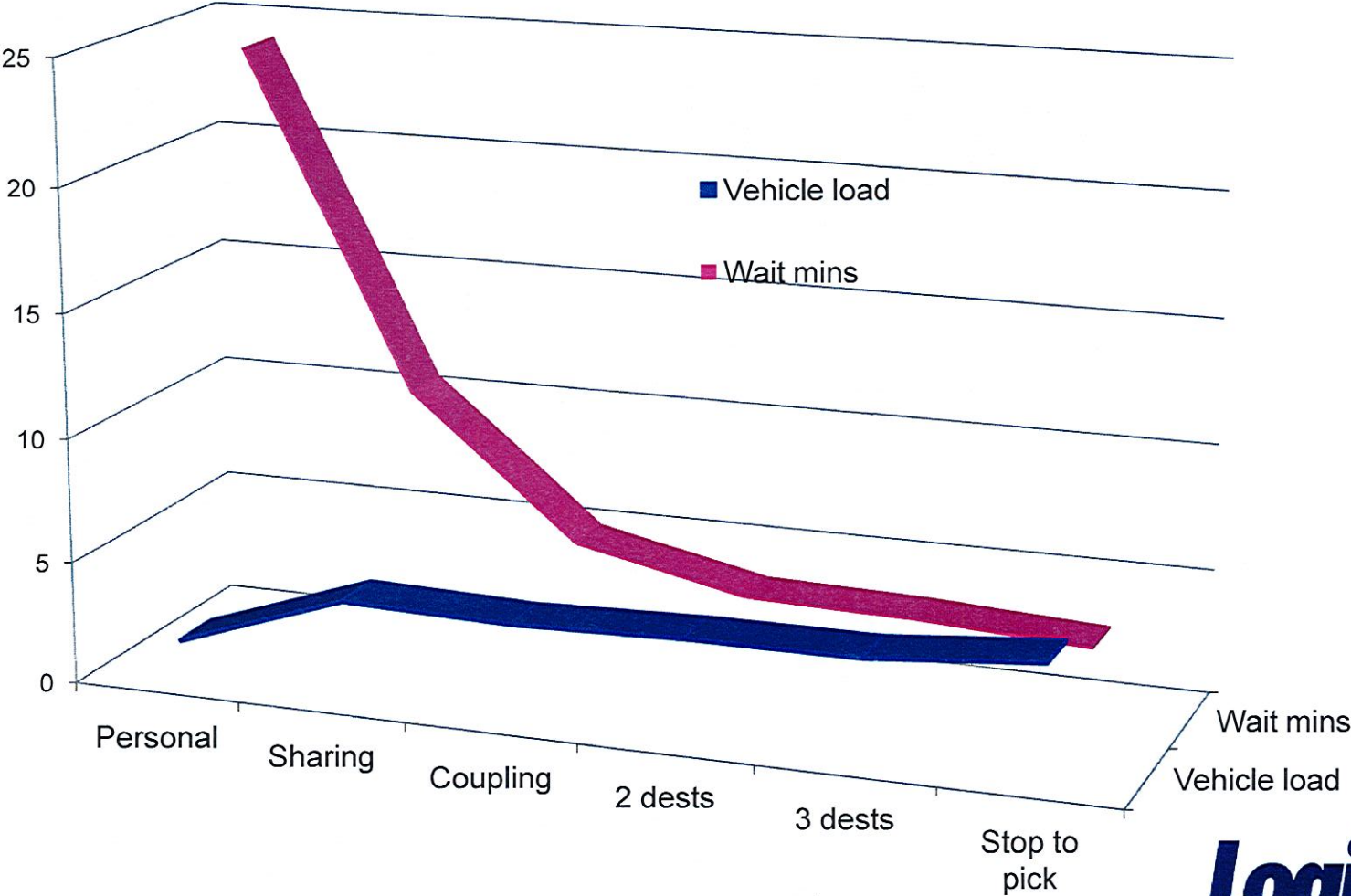



# All strategies combined

- Up to 1 800 vph on link (average coupling 1.5)
- Up to 6 passengers per vehicle
- Up to 6 000 pph on link, 13 400 in network
- 85 % of vehicles running with passengers
- 8 % running empty
- 7 % in stations



# APM for same capacity

- Stopping on-line => double travel time
- Can only serve 30 out of 50 stations
- Minimum headway 90 secs (40 deps/h)
- To achieve link flow 6 000 pphpd
- Needs to load  $6000 / 40 = 150$  passengers

## APM or LRT



$200 \text{ pass} / 90 \text{ sec} * 75 \% \text{ load} = 6\,000 \text{ pph corridor}$

## PRT



$6+6 \text{ pass} / 3 \text{ sec} = 14\,400 \text{ pph (all paired \& full)}$

Case 6 000 on link, 13 400 in network

# Conclusions

- Apply ride-sharing and pick-ups during peaks
- On demand, almost non-stop (0.3 extra stops)
- Slightly longer trips (+10 %)
- Can handle mass transit flow
  - 6 000 pph on link, 13 000 in network
- Not always Personal, but very Efficient
- Mass Rapid Transit, but faster & cheaper

PRT Minnesota Inc  
11330 86th Ave N  
Maple Grove MN 55369

SDEIS ~~Submission~~ submission



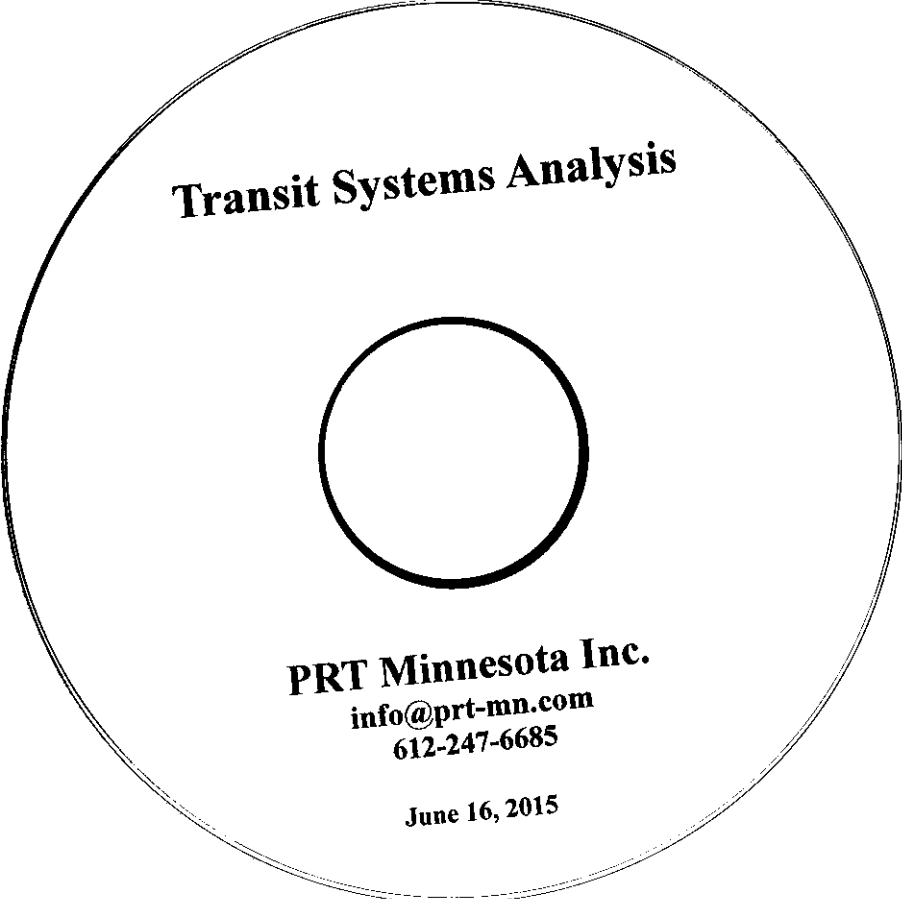

**Transit Systems Analysis**

**PRT Minnesota Inc.**  
**info@prt-mn.com**  
**612-247-6685**

**June 16, 2015**

## Appendix

### **PRT Simplifies Transit Planning, Construction and Operations:**

No vibration or acoustic noise emission.

No buried cable ducts -- communication links are in the guideway.

No at-grade street crossings.

No pilings or retaining walls

No overhead power catenary.

No large and expensive traction transformer-rectifier substations.

No ongoing track and switch maintenance

No replacement of poorly compacted soils

No relocation or abandonment of freight rail.

No "capital maintenance" funding requests to Legislature

Minimal utility relocations (at Heathrow there were zero).

Simple 13.8KV 3-phase power feed to 480V transformers.

Almost no land acquisition required (need only 50-year easements).

Trivial wetlands impacts and mitigation, thus greatly simplified and less expensive EIS.

Most of the system can be installed on existing public right-of-way.

3-berth stations can have a footprint as small as 19 ft x 38 ft (4 parking stalls)

Each additional loading berth adds about 9 ft to the length.

Rapid construction and installation.

Much smaller OMF building and yards.

Greatly reduced OMF staffing requirements.

Extreme flexibility and simplicity of system layout and station locations.

Near immunity to severe winter weather conditions.

Complete automation means lower operating costs.

Curve radii as small as 75 ft.

Vehicles can climb 10% grade.

etc.

etc.

etc.

# **Transit Systems Analysis**

**PRT Minnesota Inc.**

**info@prt-mn.com**

**612-247-6685**

**June 16, 2015**

# **Transit Systems Analysis**

**PRT Minnesota Inc.**

**info@prt-mn.com**

**612-247-6685**

**June 16, 2015**



# Range Extender for SW LRT

○ 3.6 LRT route miles    9.6 PRT route miles ○

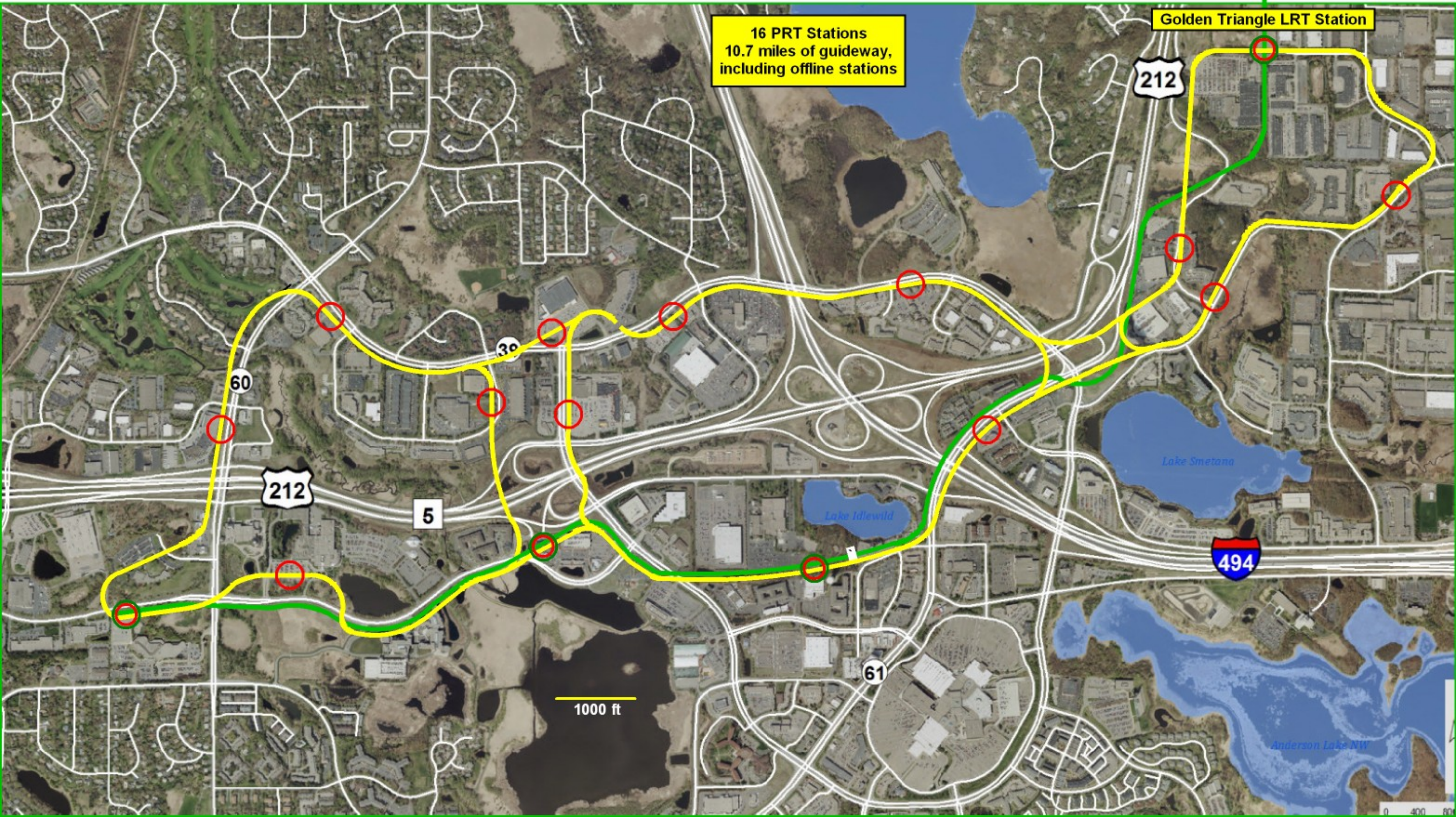

16 PRT Stations  
10.7 miles of guideway,  
including offline stations

Golden Triangle LRT Station

1000 ft

0 400 800



# Modelling and software innovations

Prof. Ingmar Andreasson  
KTH and LogistikCentrum

# Previous developments

- Generic PRT simulator PRTsim
- Dynamic routeing with look-ahead
- Reallocation of empty vehicles en route
- Ride-sharing options
- High-speed links
- Coupled vehicles

# PRT implementation

- Initial system pioneer for evaluation
- To demonstrate technology and service
- Meaningful traffic mission
- Limited size and cost
- Few destinations, low utilisation
- Can first stage be cost effective?

# Darwin's evolution principle

- Improvement in each step is necessary
- PRT system introduced in stages
- Initial stage involves transfers
- People dislike transfers
- Can first stage offer improvement?



# Stage I challenge

- Evaluation based on full system
- First phase only a step
- Needs to be large enough to be effective
- Pick the raisins first
- Connect main attractors at short distance

# PRTsim developments

- Mixed networks PRT-LRT-Bus-Metro
- Assignment on “best” combination
- Trip disutilities walk-wait-ride-transfer...
- Mode split PT-Car-Bike-Walk
- Elastic travel demand



# Eskilstuna

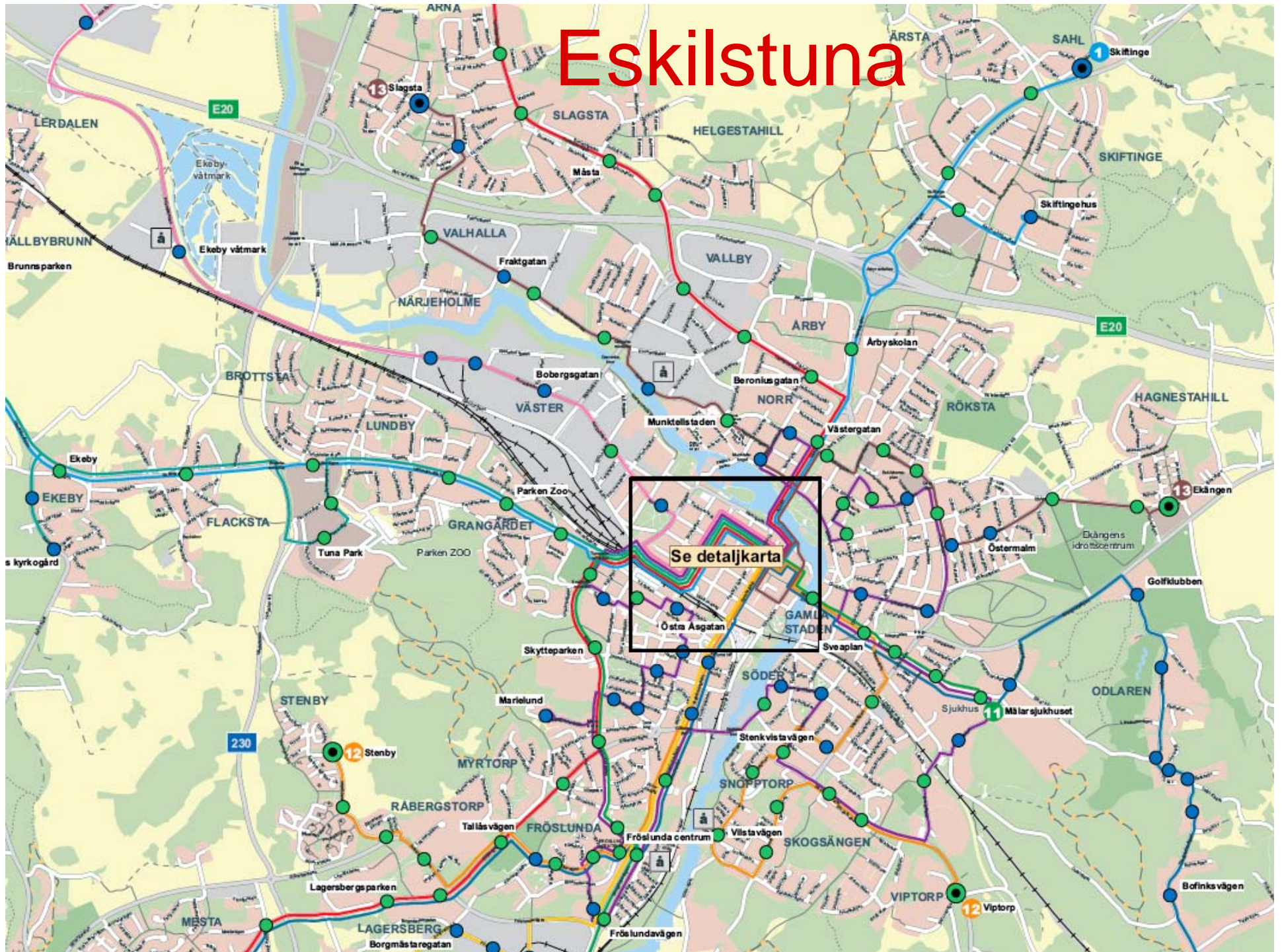



- Save ⌘s
- Erase map
- Draw map
- Scale ⌘c
- New Station ⌘t
- New Diverge ⌘d
- New Merge ⌘m
- New Link ⌘l
- New HSLink ⌘h
- Reverse ⌘r
- Show station numbers ⌘n
- Other Node Numbers ⌘o
- Show walk distance ⌘w
- New Route ⌘e
- New Route stop ⌘f
- Show route stop numbers ⌘g
- Show zones ⌘z

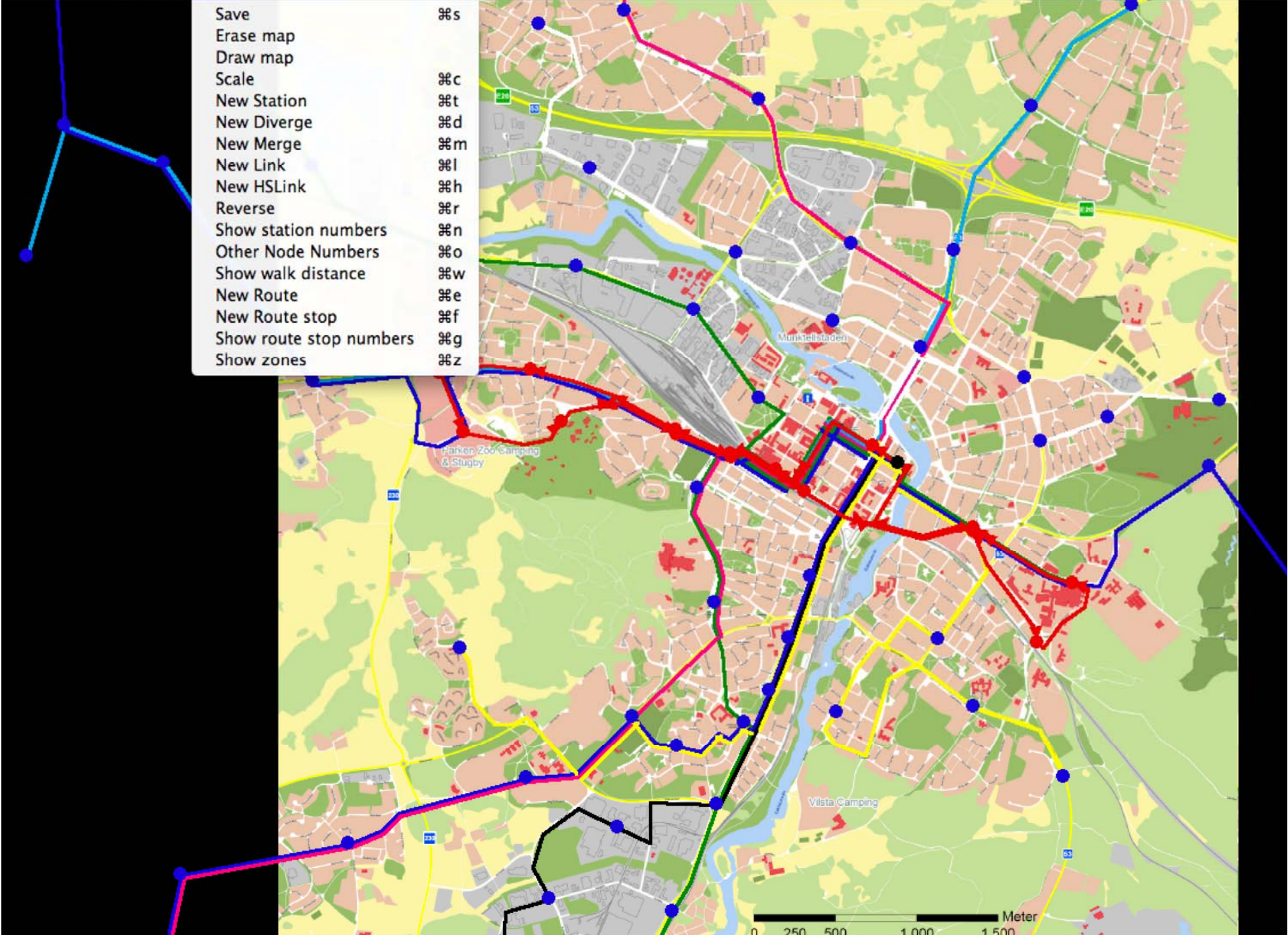



# Demand zones



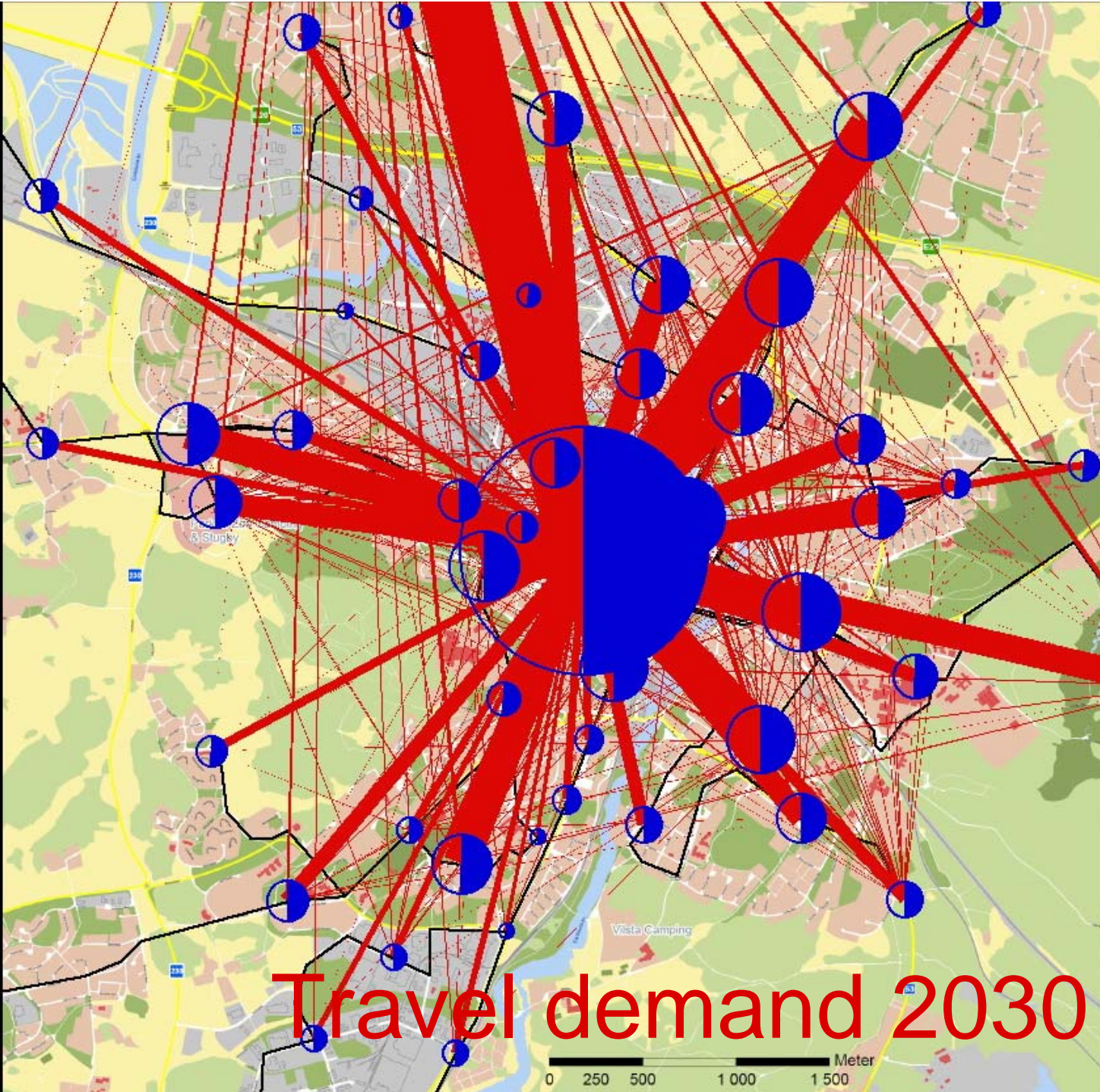

Travel demand 2030

0 250 500 1000 1500 Meter



- Erase ⌘r
- Links ⌘l
- Passenger flows ⌘f**
- Vehicle flows ⌘c
- Ride sharing ⌘s
- Empty vehicles ⌘e
- Delays ⌘d
- Draw station numbers ⌘n
- Passengers from&to stations ⌘p
- Avg waiting-times ⌘w
- Max waiting-times ⌘x
- Trip matrix ⌘t
- Accessibility ⌘a

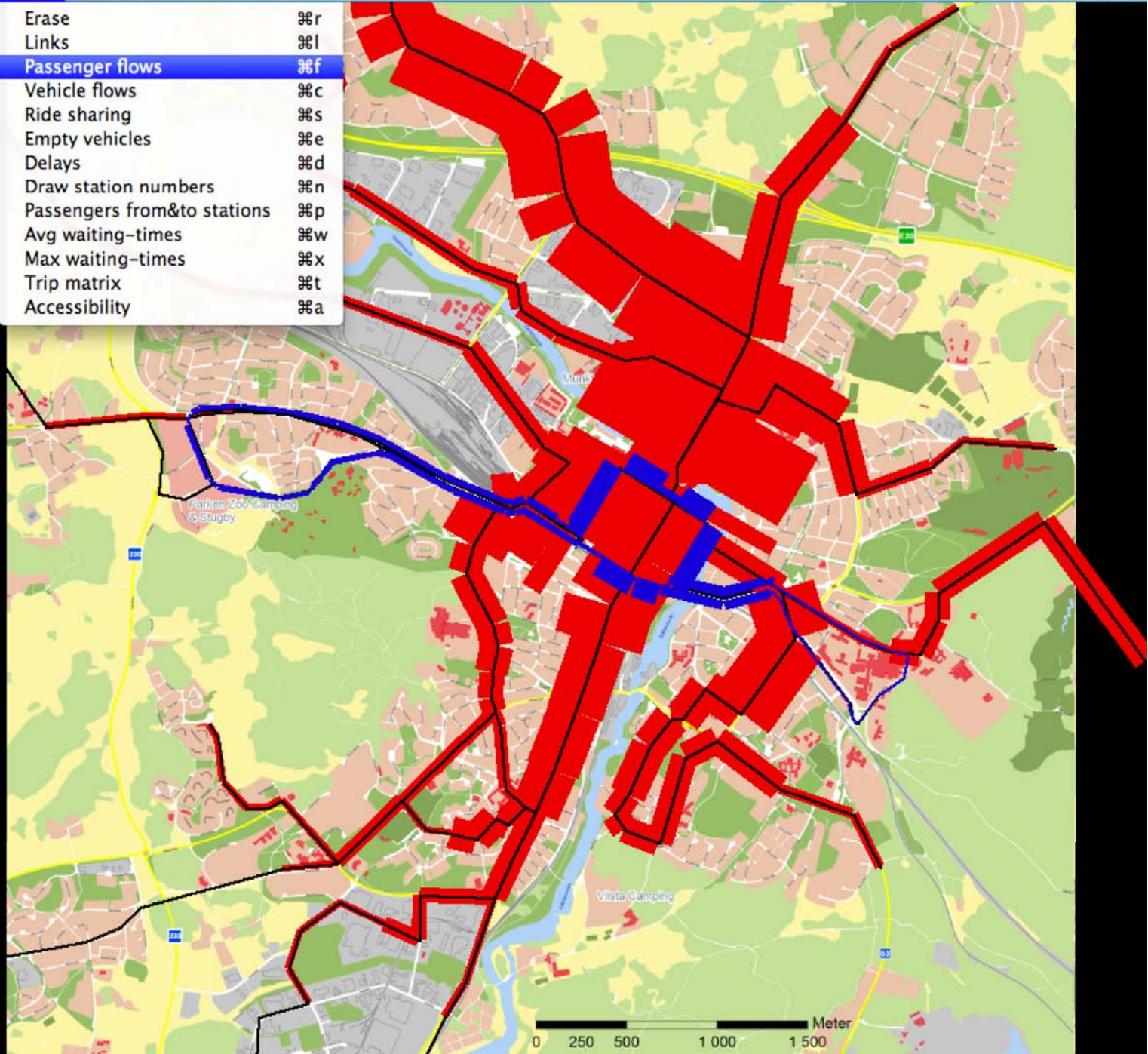

# Access time to Travel Center

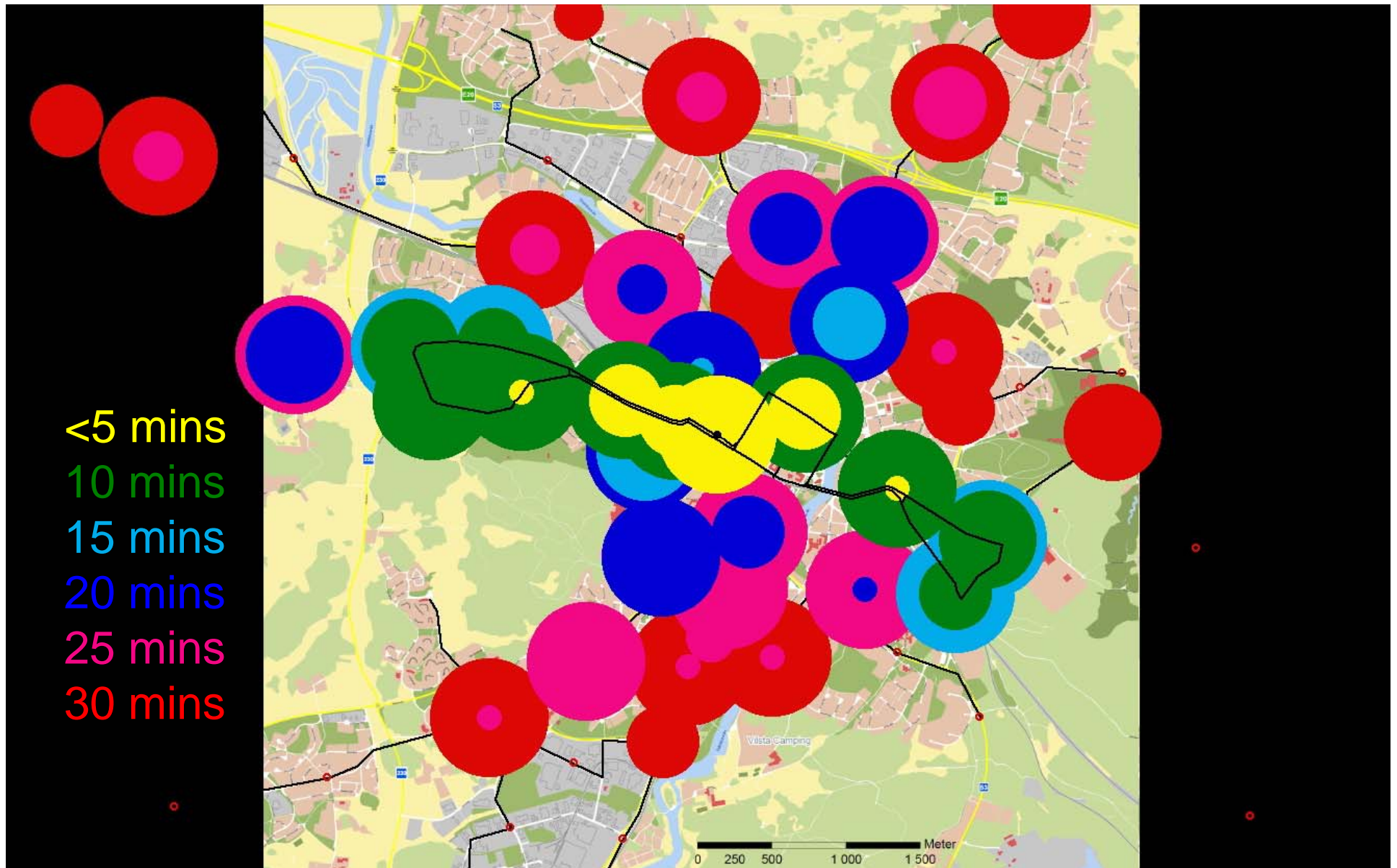



# Demo

- Edit PRT and bus route
- Animation

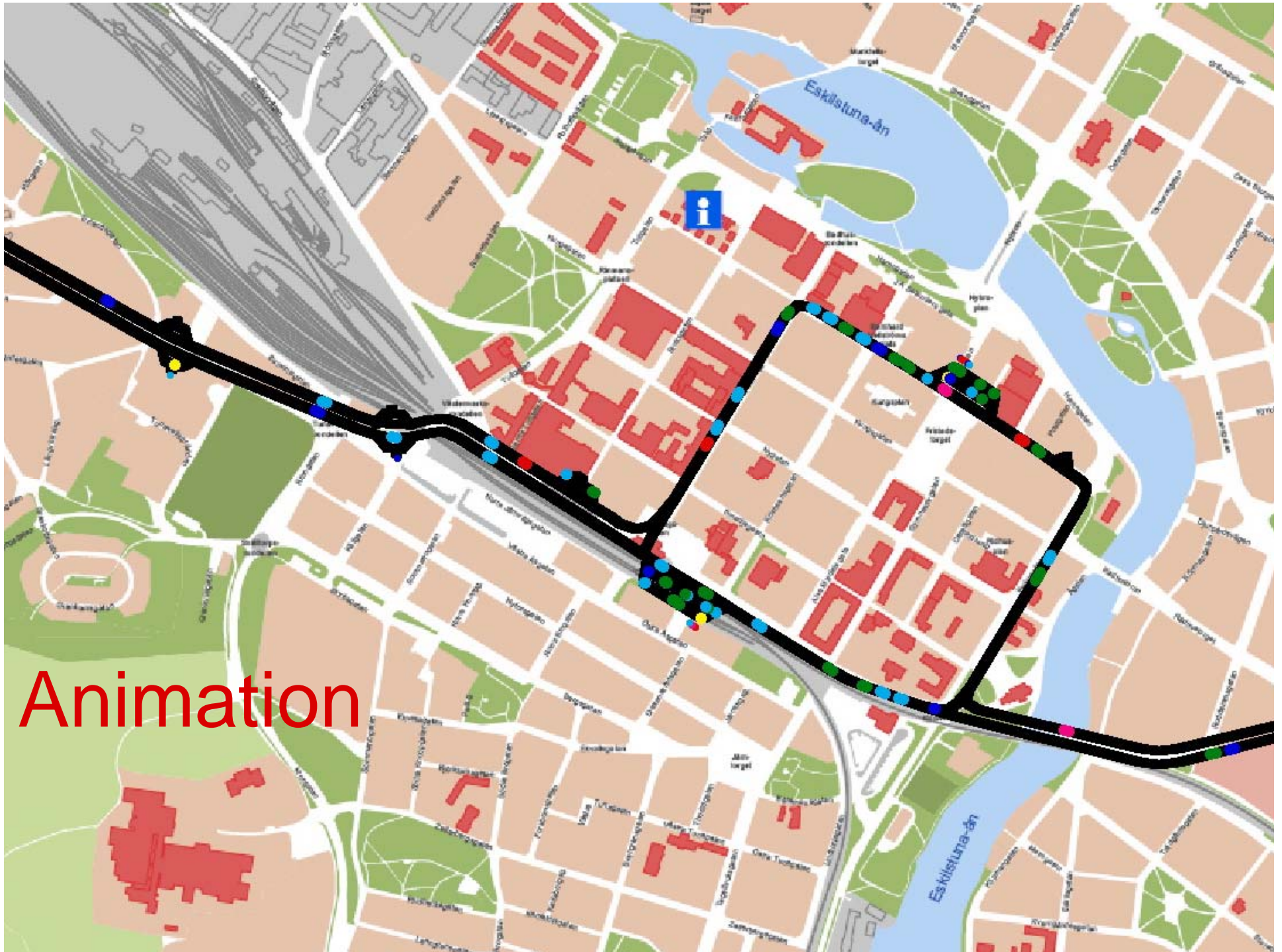

Animation

# Travel disutility

Basis for demand and mode choice

- Ride time
- Walk time \* 2
- Wait time \* 2
- Transfer penalty +5 mins
- Ticket cost

# Mode shift to transit

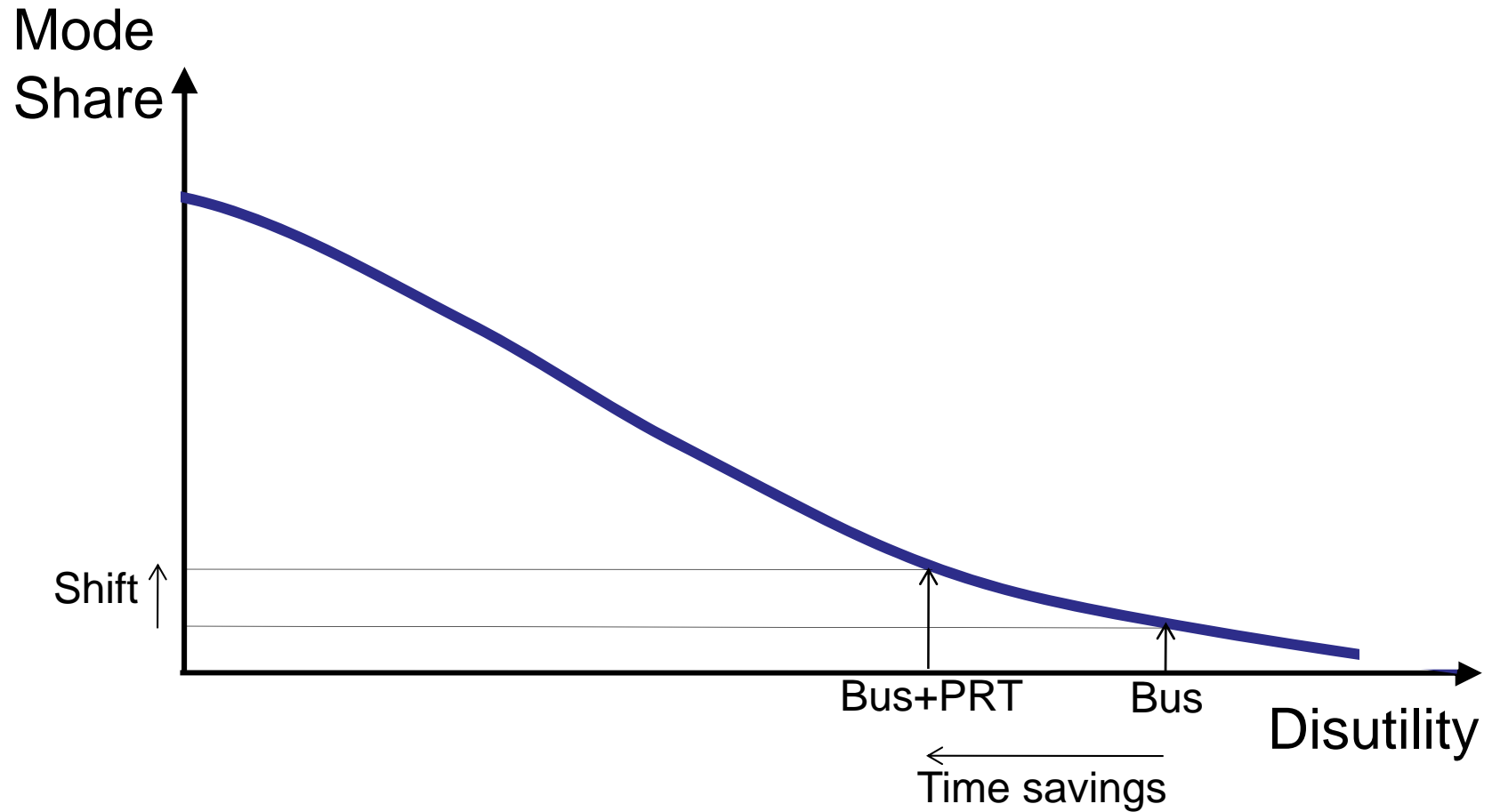



# Planning process

- Citywide PRT vision
- First stage in mixed network
- Adapt bus routes
- Elasticity estimation of mode shift
- Costs and benefits
- Basis for political decision

# Results for Eskilstuna

- Small first stage PRT (10 % of bus routes)
- Connects Center, Malls and Hospital
- Transit ridership +14 % citywide
- +100-150 % in some PRT relations
- Worth transfer for 3 kms PRT ride
- CBA positive already in first stage

# Models available

- PRTsim for all types of PRT
- Several PRT control options
- Mixed transit networks
- Effects on trip-making
- Basis for capital + O&M costs and benefits
- Evaluation of implementation strategies

# ***PRT Minnesota, Inc.***

11330 86th Ave N • Maple Grove MN 55369  
612-247-6685 • jlampe@prt-mn.com

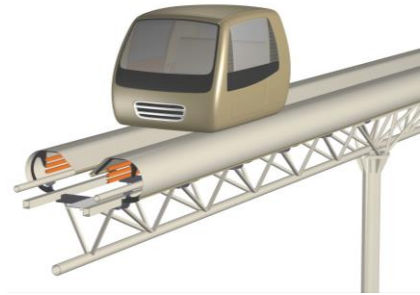

*21st Century Urban Mobility*

June 17, 2015

**COPY**

Nancy Tyra-Lukens, Mayor  
City of Eden Prairie  
8080 Mitchell Rd  
Eden Prairie, MN 55344

Dear Mayor,

This letter is addressed to you in your capacity as a member of the Southwest LRT Corridor Management Committee. Recent mandated cuts in the cost of the SW line have caught my attention, and last month I began to study the options. I have seen your written comments submitted to the Corridor Management Committee on June 3 and I am very sympathetic to the concerns and problems you raised. I am committed to solving them.

On Sunday June 7 I took a vehicle tour of Eden Prairie to examine the potential for a low cost “range extender system” if SW LRT terminates at the Golden Triangle station, which I am making the case for. Bear with me . . .

A little background -- I am a transit enthusiast. When I lived in Washington DC my mobility was primarily walking and the DC Metro. Daily transit trip share in the Twin Cities is only 3% of the 12 million daily trips by all modes. We can do better. My personal goal for the Twin Cities is 20% transit trip share by 2040.

The more I investigate the SW LRT budget cuts the more interesting it gets. I appreciate that the Corridor Management Committee currently opposes ending the line at Golden Triangle. According to the June 3 staff presentation to the Committee, the cost savings of ending it there would be \$52 to \$59 million more than the cost reduction goal of \$341 million. Additionally, other proposed cost reductions in the LRT line would be unnecessary, thereby gaining allies in the affected cities.

The savings would pay for more than half of a Personal Rapid Transit range extender system beyond the Golden Triangle. Because there would be 12 additional stations over a large area, LRT ridership would increase well beyond the original estimates. This increased ridership will improve the SW project’s Cost Effectiveness Index with the FTA. To achieve high ridership, transit station walk distances should be no more than 1/4 mile. PRT stations are close together, resulting in very short walk distances.

PRT Minnesota can build a 10.7 mile Personal Rapid Transit range extender and local circulator system for about \$10 million per connectivity mile. A conceptual map of such a system is enclosed. I have provided an earlier version of it to Randy Newton in the Public Works Department for staff to discuss.



Enclosed is a short presentation on PRT made last week to the Brooklyn Park Rotary. A collection of PRT videos is at <http://www.prtconsulting.com/prtvendorevideos.html> A video animation is at <http://www.gettherefast.org/bettercampus.html> A pro and con overview is at [http://en.wikipedia.org/wiki/Personal\\_rapid\\_transit](http://en.wikipedia.org/wiki/Personal_rapid_transit) All of these items are on the enclosed DVD.

PRT technology has advanced dramatically in recent years, in great measure because of lessons learned from the deployment of four systems in other countries during the past five years. We have designed a world-class 4th generation PRT technology. Our technology is beyond the research phase, and significant engineering development has been completed. About \$20 million is needed to bring the system to manufacturing and deployment readiness. Engineering innovations from our California-based control system provider and from Ingmar Andreasson in Sweden allow peak traffic period throughput of 14,400 persons per hour, using paired 3-person vehicles at 1.5 sec headways. Ingmar's presentation at the Podcar City 8 conference is available at [https://www.youtube.com/watch?v=RI\\_2YgS9JXg](https://www.youtube.com/watch?v=RI_2YgS9JXg) and is on the enclosed DVD. A paper copy of Ingmar's PowerPoint presentation is enclosed.

The partnership of PRT Minnesota and Transit Control Solutions (TCS) has designed a PRT system with 60 MPH speeds and one second intervals between vehicles. Trip times and wait times for the PRT system will be much shorter than trips on current transit systems. Urban travel by PRT will be time and cost competitive with travel by automobile.

The TCS vehicle control system is the world's most advanced Communications Based Train Control, based on their Dynamic Block Control (DBC) technology. The TCS founder, Eugene Nishinaga, has a patent for the DBC technology, with ten more to follow. He had 37 years of employment in the transit industry, most of it with BART, followed by eight years of R&D on PRT and train control technology.

Our physical design and control technology is driving down the cost and vastly increasing the performance of PRT relative to recent systems built in other countries by Ultra, Vectus, 2GetThere and ModuTram. A major reason for skepticism of PRT by public transit agencies is that the Morgantown WV PRT and the newer PRT systems are relatively low speed and low capacity. There are no PRT designs in the US or elsewhere with the advanced functionality that the PRT Minnesota design has. Our guideway and vehicle concepts were greatly influenced by a world famous roller coaster designer.

PRT has been trapped in a loop for decades:

- The customer (such as Eden Prairie) needs a product
- The product development needs an investor (about \$20 million)
- The investor needs a customer

But we are getting close to breaking out of this loop, and Eden Prairie may be part of the solution. The city has the most ideal structure for PRT that we have found in the USA.

Historically PRT has been rejected because of its perceived low speeds and low capacity and the lack of real-world deployments. Our control, vehicle and guideway technologies solve the speed, capacity and cost issues. PRT is a proven technology, with five automated systems now operating in five countries. Driverless automated vehicles are rapidly joining

the transportation world. Rivium in the Netherlands even has a driverless automated bus system, called Park Shuttle, in operation since 2008:

<http://www.advancedtransit.org/advanced-transit/applications/rivium/>

Self-driving vehicles require control technology at least 10X more complex than PRT control, but it is being done and therefore PRT control can be done.

The low capital and operating costs of PRT, coupled with very high capacity and short trip times, means that public agencies can build PRT systems for a fraction of the cost of current transit, while achieving high ridership and reaching deep into low density suburban areas. Fare box revenues can pay the construction or operating costs. Federal government money is not needed.

Because of slow and inconvenient service compared to automobiles, transit in the US carries only 1 to 2 percent of all urban daily trips. Only six US cities have transit trip share above four percent. In our metro area daily trip share is 3%. To have a large share of daily trips, transit has to "go everywhere all the time, with automobile competitive travel time." Buses have large networks, but trip times are too long and rail has too few destinations as well as long trip times.

Transit mode share is determined by walk time, wait time, ride time, transfer time, fare, number of origins and destinations, plus other criteria like health status, age, weather and "can you afford to own and operate a car?" Total trip time is the most important factor. Current transit technology is not automobile competitive, so few people use it unless they absolutely have to. Because current transit is not a workable travel mode for most people, they drive cars. But traffic congestion continues to increase. The number of vehicle miles traveled each year increases much faster than lane miles of roads. Buses can't attract riders and there is not enough money and land to build sufficient roads and urban rail systems.

High performance PRT is the only urban travel mode that can overcome these limitations and problems. It can be built and operated at low cost relative to other modes, and can provide high capacity, large numbers of origin destination pairs and short trip times, thereby attracting riders. It is time to demonstrate these characteristics in an environment where it is complementing rather than competing with rail transit.

The decision process on SW LRT is moving rapidly and I would like to meet with you to discuss a path forward to building a world-class transit system for Eden Prairie that will complement the SW Corridor project.

Sincerely yours.

Joseph Lampe, President  
PRT Minnesota, Inc.

cc: City Council  
Corridor Management Committee

# PODCARS - A Personal Rapid Transit primer

## PODCARS a PRT primer

September 13, 2009

### PODCARS a PRT primer

#### Part 1



David Gow  
Seattle Transportation Examiner

This year has seen an increasing stream of news, **Examiner.com included**, about the mass transit alternative concept Personal Rapid Transit (PRT) -- also known as "podcars."

Stories on podcars are usually followed by discussions among readers speculating about what PRT is, how it would work, or why is it needed. Answers tend not to resolve their questions to any great satisfaction.

I have some insights into the subject, having observed PRT development for nearly twenty years. Wider public understanding is needed about PRT, because there are two PRT projects that are to begin operating soon -- short initial phases of what could become larger PRT-based transit networks. In the next few years, your community could start thinking about adding PRT to existing transit services, and your thumbs-up or thumbs-down needs to be an informed one.

#### How PRT would work



2getthere

**Taxi 2000****Vectus**

The PRT concept is pretty straightforward: imagine splitting trains into small segments -- 4 to 6 seat pods. Each segment can run around separately on an elevated guideway, driverless, under computer control. The guideway connects stops (stations) distributed across a service area, forming a network. Each stop is located on a siding off the main guideway, so that loading or unloading passengers at one stop doesn't block pods going elsewhere. Designers of PRT systems believe small light weight vehicles have economic advantages -- they can use smaller profile guideways, and therefore could have lower per-mile capital cost. It is hoped that PRT can build more miles of transit, reaching more places and expanding the base of transit users.

Pods would operate on-demand instead of according to schedules. During off-peak periods the pods would wait at stops until needed. A traveler would go to a PRT stop, request a ride by selecting a destination stop from an ATM-like machine, provide payment, then board a pod that would take her on the most direct route (balancing distance and time) through the network to her destination, bypassing intermediate stops. When the ride is over, the pod is available for another user.

You might be surprised to learn that on paper PRT is more energy efficient than trains and buses. Due to our experience with automobiles, small vehicles are assumed to be more wasteful. But a big part of energy use in any type of transportation correlates to the amount of vehicle weight that must be moved with the passengers. A 50 ton light rail car with 70 seats is moving over 1,400 pounds per seat, a 23 ton articulated hybrid bus with 58 seats has 769 pounds per seat, and a 7,000 pound six-seater Escalade has 1,166 pounds per seat. In contrast, a six-person PRT pod might weigh only 900 pounds, or 150 pounds per seat.

Other sources of energy waste in transit are frequent starting and stopping (addressed when



vehicles have regenerative braking) and low occupancy. Because the average occupancy on transit (the occupied percentage of all available service) is on the order of 15%, government statistics on transportation energy show transit as sometimes less efficient than automobiles (see Fig. 2.12 and 2.2 at **this Center for Transportation Analysis page**). However, the automobile's dominance has a cumulative effect that more than overcomes any small statistical differences -- and for **CO2 emissions as well** as energy.

Capacity in a PRT system is mostly a function of the number of pods, and short headways between them. Congestion is avoided by having a set number of pods, in contrast to the continual increase in new automobiles being put on the roads. Capacity is the number of trips each pod makes, times the number of seats per pod, times the number of pods in the system. Just as an example, in a fleet of 1,000 four-seat pods each making five trips per hour, the capacity is 20,000 passengers per hour. Therefore on-demand service is the chief difference between PRT and light rail -- light rail is good at moving large groups in trains many minutes apart, along corridors; PRT serves the same number in smaller groups, with pods sometimes separated only by seconds, around a grid-like network.

In addition to bus and rail schedules, there is another feature of typical transit that isn't part of PRT: each trip is an express ride to the selected destination. Rider groups are determined at the start of the trip. The odds of people going from the same point A to the same point B at exactly the same time is quite low, so travelers share a pod when they plan to travel together, or several strangers going to the same place can negotiate ridesharing.

And because pods are usually ready and waiting, crowds aren't expected to accumulate inside PRT stops, so most stops can be comparable in size to an elevator lobby. Crowds at train platforms and bus stops are partly caused by having to wait for scheduled departures -- that's not a judgment, it's just how scheduled transit works.

PRT seeks to address the need for convenient transit access by having relatively short distances between stops. Because stops are on sidings, they don't slow down PRT traffic the way average speeds of trains and buses are reduced by frequent stops. The ideal is that, within a PRT service area, people should never be more than a quarter-mile from a PRT stop -- they are more likely to walk to PRT and not drive. Thus the ideal distance between stops is about a half mile. These small ridersheds also benefit the PRT network's performance -- rider demand and pod traffic is more dispersed than if there were fewer stations. This also helps keep the size of stops small.

PRT is network-based and on-demand, and therefore can't be evaluated in the same way as corridor-based, scheduled conventional rail. Forgetting this difference has been a major source of

misunderstanding over the years, and continues to this day.

**Next time:** Part II - Origins

# PODCARS - Origins

---



David Gow  
Seattle Transportation Examiner

September 13, 2009



---

## Part 2

It is generally agreed that a transit concept resembling Personal Rapid Transit as we now know it was first developed in the 1950s by Donn Fichter, a graduate student and later an official with the New York Department of Transportation. Fichter published his work in a book, "**Individualized Automated Transit and the City**" (1964).

The idea came to the attention of the nonprofit Aerospace Corporation, a federal R&D center, which essentially defined the state of the art of the new technology. **A scale model was tested** that successfully **demonstrated the different aspects** of the PRT concept, and in 1970 PRT was added to a list of new technology initiatives given to the White House Office Science and Technology. Nixon reportedly decided, "**If we can send three men to the moon 200,000 miles away, we should be able to move 200,000 people to work three miles away.**" The transit initiative came only a year after establishment of the Environmental Protection Agency and OSHA. The following year Nixon created the Consumer Product Safety Commission and the Watergate cover-up.

But a federal PRT project was launched in 1973, with the ambitious goal of creating a high capacity system with minimum headways of a second or less. The US program was paralleled by competing efforts in England, West Germany, France, and Japan. Of the overseas programs, only West Germany produced a finished product: **Cabintaxi**, by Messerschmitt-Bölkow-Blohm.

Although MBB and regulators said it ready to be built somewhere, Cabintaxi **was torpedoed in the 1980s** when the government backed out because of a general budget crunch. Today the technology **lives on as a hospital shuttle** in Schwalmstadt, Germany.

The American PRT program resulted in just one installation, connecting the three-part campus of the university in Morgantown, West Virginia. Built by a Boeing-led contractor team, the essentially experimental project suffered from design changes that resulted in guideway and vehicles being too large. There were cost overruns, minimum headways are 15 seconds, and it only runs in PRT mode part-time. But since going public in 1975 it has logged more than 20 million miles, carried over 60 million passengers, and is in service 98% of the time. An expansion is currently being studied.

### **Morgantown PRT links:**

### **WVU's one-of-a-kind transit system rolls on**

### **Boeing History: Personal Rapid Transit System**

### **City's White Elephant Now Looks Like a Transit Workhorse**

### **Next time: Part III - Close but no cigar**



# PODCARS - Close but no cigar



David Gow  
Seattle Transportation Examiner

September 21, 2009



Part 3

## The Raytheon PRT program

The 1970s ended with Personal Rapid Transit operating in Morgantown, West Virginia -- but in a form too large and expensive to be reproduced in other American cities. The other market-ready system, West Germany's Cabintaxi, was canceled by a budget crunch -- the Reagan administration demanded its NATO allies spend more on their military.

PRT development in the post-Morgantown era tended to be small teams of undercapitalized designers laboring in quiet obscurity, but one effort rose above the others. After Cabintaxi, the PRT torch was picked up by an engineering professor named **Ed Anderson** (MS Minnesota, PhD MIT) who was also a former Cabintaxi rep. By the mid-80s Anderson had developed his own PRT design, "**Taxi 2000**," involving light weight pods on slim guideways.

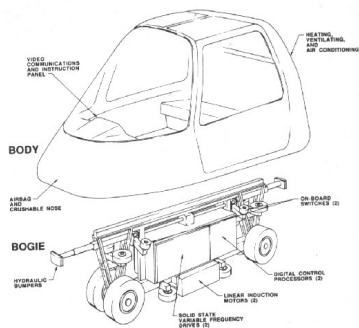

*Anderson's original design*



Raytheon PRT2000



Skyweb Express, a vehicle based on the original design (2003)

In the early 1990s the Chicago Regional Transit Authority became interested in Anderson's design, in order to create a prototype system that would complement commuter rail. He was **already working with Raytheon**. After a public competition, the RTA chose the suburb of Rosemont as the project site. **PRT would provide links among** hotels, civic facilities and the adjacent O'Hare airport, and serve as a feeder to a Chicago Transit rail station.

Raytheon proceeded to change Taxi 2000 beyond all recognition; the **megacorporation dubbed its version "PRT2000"**. The vehicle was made too large and heavy, and its wheels also too large. Because the wheels had to fit inside the guideway, that too had to be bigger and therefore more expensive as well. The guideway was built atop an unsightly and unnecessarily large 36" diameter steel pipe. Raytheon even **wrote its own control program** instead of using Anderson's. Nevertheless, a test track with three pods and a station was built in Massachusetts, with costs shared by Raytheon and Chicago RTA. It was a technical success. However, the sticker price to build PRT2000 in Rosemont had escalated, possibly to more than \$35 million per mile.

It still would have been cheaper than some conventional systems, but it was a far cry from the hoped-for affordable alternative. Interest in Chicago, as well as in SeaTac, Washington (**SeaTac Major Investment Study**, 1997), rightly evaporated.\*

But even as Raytheon was canceling PRT2000 in 1999, the next wave of PRT development was already underway.

**Next time:** Part IV - Misunderstanding PRT

## PODCARS Series

### Part 1

### Part 2

\* Out of the rubble came two successor programs: a reborn **Taxi 2000** which created a small prototype in 2003; **PRT International**, a new company Anderson founded in 2006 after **losing control of Taxi 2000**.

# PODCARS - Misunderstanding PRT

---



David Gow  
Seattle Transportation Examiner

September 27, 2009



---

## Part 4

A number of individuals and groups express doubt that Personal Rapid Transit would be useful, and say it would be a waste of limited public funds. Some are even opposed to attempting it with private funding. Sometimes disagreements get heated on both sides.

PRT is a new concept for most, so misunderstandings about technical issues are to be expected. People get it when their questions about PRT are answered clearly and simply. But at the extreme there is a group of people who support transit, yet are adamantly opposed to PRT.<sup>1, 2, 3</sup>

But why should transit supporters get *extremely* bent out of shape over PRT?

One example, perhaps the **most prevalent vein of opposition**, arises out of conspiracy-fueled logic that reads like theories about President Obama's birth certificate and Sarah Palin's "death panels." This school of thought variously claims that PRT is **technically impossible** and/or **demonizes PRT as a right wing political conspiracy** stretching back three decades.

Minimal investigation shows PRT prototypes have received safety approval from the 1970s up to the present day, and the latter claim is more likely the result of bureaucratic infighting. Yet there are a host of other outlandish claims, and new ones keep coming to the fore thanks to a small but vocal cadre that **claims PRT is a "stalking horse"** -- part of a conspiracy to stop conventional (usually light rail) transit projects.

Obviously, these claims do not overcome what is *prima facie* to most people: a technology doesn't have a say over who uses it.



But it is also true that the PRT community brought some of this grief on itself, mostly in Minnesota. That state has been a hotbed for PRT since the 1970s due mostly to one man: Ed Anderson, whom we met in Part III. Following the 1999 cancellation of Raytheon's "PRT2000, which was loosely based on Anderson's "Taxi 2000" (T2) Anderson won back the rights to the design and, as in the 1980s, struck out on his own.

Democrats and environment/transit activists should have been the ones most excited by PRT. But in Minneapolis they had been working hard to get more conventional transit approved and built; they understandably showed little interest in the high-tech alternative.

Responsibility for what followed is unclear, but the political missteps likely can be explained by the fact that PRT is created by engineers, and engineers are not politicians.

For the most part rebuffed by the local pro-transit coalition, T2 and supporters in the community turned to the only ears that seemed willing to listen -- Greens at the local level, and Republicans at the state level.

The agenda was modest -- not outright funding for a PRT installation or even a testing facility, but rather incentives to attract private investors -- such as sales tax exemptions for purchases made by PRT companies. Such benefits are of the type states commonly award to local industries. Somehow, after several years this effort led to the egregious Congresswoman Michele Bachmann, then a Minnesota state senator.

None of the proposed PRT legislation ever passed, yet a meme was born. Some seized on the Republican cooties on Minnesota PRT as a means to cast their opposition to PRT in partisan ideological terms everywhere in the world. Examples of some of the allegations:

- *Only right wing extremists want PRT.* This claims Bachmann proposed a "PRT boondoggle." In reality Bachmann **proposed adding the words "personal rapid transit" to Minnesota's lengthy list of types of public projects eligible to be funded by bonds.** That was in 2004, and she hasn't said a word since about PRT, or introduced federal legislation about it -- nor did any other Republican in all the years they controlled Congress after the 1994 midterm elections.

Ed Anderson (see **Part 3**) -- **an arms control activist** during the Reagan administration -- was likely not very happy with Bachmann's involvement. The year after her bill, Anderson left T2 to start a new PRT company.

The claim that PRT is only supported by conservatives seems true only when the person making the claim ignores the list of notable **PRT supporters from the progressive side.**

- *PRT is linked to a torture scandal, captured on video, involving a member of the United Arab Emirates royal family.* In reality the only real linkage is geographic -- PRT is only one part of Masdar City, a planned carbon neutral research community being built outside Abu Dhabi, and the project is headed by a *different member* of the ruling family. In addition, the project agreed to abide by the ten principles (including social goals) of the **World Wildlife Fund's One Planet Living program** in return for that program's **endorsement**.

Masdar is therefore correctly viewed as an opportunity to *constructively engage* the UAE on human rights.

- *PRT for just one metro area would cost "trillions" of dollars.* In reality, even \$2 trillion is an absurdly massive portion of all the money in the world. Even the world's most advanced train now operating, the maglev Shanghai Transrapid, cost an estimated \$1.33 billion -- **0.13%** of a trillion.

But even if PRT advocates *did* want to junk trains and buses, the promoters of the conspiracy theory forget one important thing: advocates alone don't determine public policy. There is no way a pod transit plan could be studied, planned, designed, and funded without being vetted by government transportation planners, commented upon by neutral experts both with and without skin in the game, and approved by officials answerable to elected representatives -- and maybe okayed by the representatives and the voters themselves.

For the alleged "PRT scam" to work, everyone would have to be in on it. Can you imagine any jurisdiction deciding to *totally replace* its light rail or subway system with pods? Of course not -- if a city chooses to implement pods, it will be to fill specific niches within a multimodal transit strategy.

**Next time:** Part 5 - Is it the future yet?

PODCARS Series

**Part 1**

**Part 2**

**Part 3**

# PODCARS - Is it the future yet?

---

cIMG\_6384(Large).jpg

October 1, 2009



David Gow  
Seattle Transportation Examiner



---

## Part 5

The year 1999 saw Raytheon withdraw from the Personal Rapid Transit field with the cancellation of its PRT2000 program (see **Part 3**). But many disappointed PRT advocates may not have known that a successor was already in the works.

An engineer named Martin Lawson started working on transportation at Bristol University in 1995. Lawson previously worked with the American space program on Apollo, which no doubt emphasized for him how quickly humanity went from Earthbound, to flight, to space travel. So when Lawson turned his attention to Earthly transportation, what he noticed were the historical changes -- **every 50 years or so we experience the rise of a new transportation mode**, involving a new vehicle and infrastructure.

Lowson decided to derive a concept that would succeed the motorway (*motorway* -- because he's *British*). He reasoned that whatever the new mode is, it would involve computing and information technology. But it would not involve merely applying IT to the dominant paradigm. Instead Lowson decided to identify the actual requirements of urban travel, and **what he came up with** was:

The optimum urban transport (again, *British*) system should-

- be available on demand
- go non-stop from start to destination
- be easily accessible and offer a full choice of destinations
- be environmentally sustainable
- have a low cost
- have demonstrably high safety, together with personal security
- integrate well with other forms of transport.

The optimum system turned out to be Personal Rapid Transit. Lowson dubbed his version ULTra (Urban Light Transport). ULTra is a four-wheeled, rubber-tired, battery-powered electric vehicle that steers like a car. Lasers are used to navigate along an exclusive guideway that resembles a footbridge. By not being locked into the guideway like other PRT concepts, ULTra vehicles can do things like operate on the surface if needed, and pass each other at station platforms.

After a few years the project -- spun off by the university under the name **Advanced Transport Systems (ATS)** -- designed and produced a prototype ULTra vehicle. A test track opened in Cardiff, Wales, in 2002 with support from the British government and **European Union**, and the design was **successfully tested and perfected**.

In 2005 ATS signed a deal with BAA (formerly British Airports Authority) to build a first ULTra system at Heathrow Airport Terminal 5. Construction started in 2007, finishing in October 2008; since then it has been running test operations and giving rides to **reporters, consultants** and transportation officials.

ULTra is now in its final stage at Heathrow, the "commissioning" stage which ends in final regulatory certification and public operations. This phase is taking longer than impatient PRT advocates would like -- originally slated for the 4th quarter of 2009, the public opening has been moved to spring 2010.



This initial phase with 18 pods fits the "shuttle" niche. However should BAA expand it to the rest of the airport and surrounding area **as intended**, it would have a level of service sufficient for many towns and suburbs.

In addition to ULTra there are currently two other PRT programs likewise positioned to be among the first since Morgantown to go into actual public service -- finally becoming the 'transit of the future,' as PRT has been called.

Cybercab by 2getthere (The Netherlands). This company has been around for some time, and has expertise in automating coaches, low speed parking lot shuttles, and goods movement in factories. Its Cybercab podcar (styling by Zagato, of Ferrari fame) shares many characteristics of ULTra, but navigates by following magnetic markers.



Cybercab is part of the **Masdar carbon neutral city** project in Abu Dhabi. Cars will be banned inside **Masdar**. Light rail and a metro will link Masdar to other cities, but motorized transit within



Masdar will be solely provided by PRT, which will operate subway-style in a utility services level (basement) below street level. An initial track circuit is being set up to serve the first Masdar building to be completed, the Masdar Institute of Science & Technology; **Cybercab testing** is said to be underway.

**Vectus** by POSCO (South Korea). POSCO is one of the world's biggest steel companies, and it shows in the Vectus PRT guideway: a steel tube with guideway mounted on top. It looks like the Raytheon PRT2000 guideway, but a **side by side comparison** shows it is much smaller. Unlike ULtra and Cybercab, the Vectus cabin is on top of a wheeled undercarriage (called a 'bogie') that is locked inside the guideway. Propulsion occurs by linear (magnetic impulse) motors in the guideway.

POSCO only got into the PRT game in 2005, as part of a business diversification strategy. The first step was a scale model to test their approaches to propulsion, switching and control. Then it was on to a full scale version in the college town of Uppsala, Sweden (**see it**). Not only did this enable Vectus to be tested under wintry conditions, but regulatory approval in Sweden (which was granted in 2008) also applies to the rest of the EU, hence opening Europe as a potential market.

POSCO is likely in the lead to be supplier for Sweden's national podcar program. This effort, which arises from the country's goal of **ending its dependence on oil by 2020**, envisions construction of podcar networks to act as local transit, and serving as tendrils of the national rail system. **Last month the government released its slate of sites** for the first PRT network, a list topped by Sodertalje, Umea, the 'Science City' in Stockholm, and Uppsala. The next steps are to select one location -- and organize the funding.

Finally, in a new development, POSCO last week signed a **memorandum of understanding to build a Vectus system in Suncheon**, a city on the south coast of South Korea.

There are **many other planned podcar concepts** at various stages of advancement. There always have been -- testament to the intuitive power of PRT's basic concept.

What caused the current resurgence of PRT activity to happen in Europe and not the United States? Mostly two factors: the need, even in a transit-paradise like Europe, to **improve overall transportation**, and forward-looking **environmental priorities**.

**Next time:** Part 6 - Toward a transit-oriented city

Updated

PODCARS Series

**Part 1**

**Part 2**

**Part 3**

**Part 4**

# PODCARS - Toward a transit-oriented city

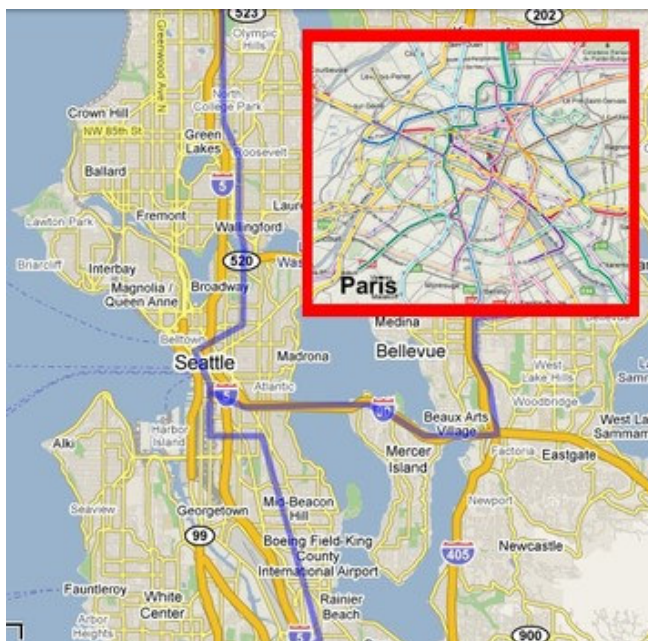

David Gow  
Seattle Transportation Examiner

October 11, 2009

## PODCARS a PRT primer

### Part 6

(Updated) You might still be asking why a new technology like Personal Rapid Transit is needed. Instead of these podcars, why not simply build more of the conventional systems?

The answer lies in the challenges of making a compact, dense and walkable city out of one with patterns laid down in the automobile era. Seattle is 84 square miles, with population density just under 7,200 per square mile. It is too late for the city to be made compact. After Central Link light rail is built out to Northgate, there will be 16

stations inside the city proper.

For contrast, compare the Seattle area to the world's leading urban subway systems:

NEW YORK	PARIS	LONDON	TOKYO	KING COUNTY, WA (2023)
area: 304.8 sq mi	area: 41 sq mi	area: 659 sq mi	area: 239 sq mi	Urbanized area: 460 sq mi
Density: 27,440	Density: 65,700	Density: 12,331	Density: 53000	Population: 1.91M Density: 3846

MTA stations: 469	stations: 245	stations: 268	stations: 317	stations: 39
lines of MTA rail: 22	lines: 16	lines: 11	lines: 14	lines: 3 light rail, 2 heavy rail
miles of MTA rail: 242	miles of rail: 133	miles of rail: 290	miles of rail: 200	miles of rail: 54 light, 82 heavy
<b>New York MTA</b>	<b>Paris Metropolitain</b>	<b>London Underground</b>	<b>Tokyo Metro and TOEI subways</b>	

Let's look at Paris. Its twenty districts -- 65,700 people per square mile -- comprise a mere 41 square miles. Within that are 245 metro stations (seven per square mile), with the average distance between them 1,845 feet -- a third of a mile. Meaning the walking distance to a station (radius of station ridershed) is half that, only 923 feet. Such a system is said to have **finer grain** (or **granularity**).

For Seattle to reach such levels of rail transit availability is unattainable at today's prices. Seattle is not compact -- to emulate Paris, 588 stations would be needed! And uniform high population density within the city limits would be politically impossible, as well as strain the utilities infrastructure (water, power, waste) -- just one third of Paris-level density would triple Seattle's population.

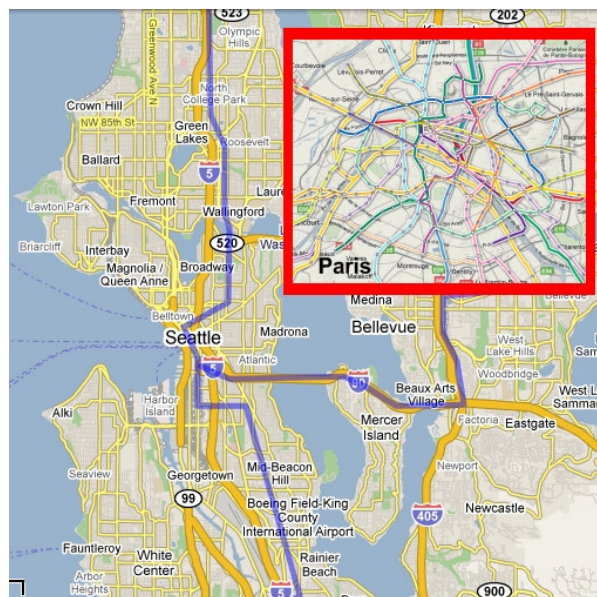

Seattle Link vs. Paris Metro  
(Inset is at the same scale)



Obviously we can't afford to build 588 stations worth of light rail in Seattle, let alone what would be needed for the urbanized area of King County or central Puget Sound region. PSRC projects the county population will grow to 2.47 million by 2040, meaning a density of 5370 per square mile. To reach London levels of rapid transit, we would need 187 light rail stations and 1045 miles of rail.

We should plan now to extend the current "backbone" train system into a decent urban rapid transit network. Central Link's phase 1 is already laid out like a metro line, so why not add (1) a line in the old Green Line monorail alignment to Northgate, (2) an Aurora Avenue line, (3) a line reaching Georgetown, South Park and Burien, (4) service for the rest of the I-405 corridor, and (5) a line in the I-90 corridor east of Issaquah, maybe as far as North Bend. Where sprawl has already gone, we need to provide rapid transit options.

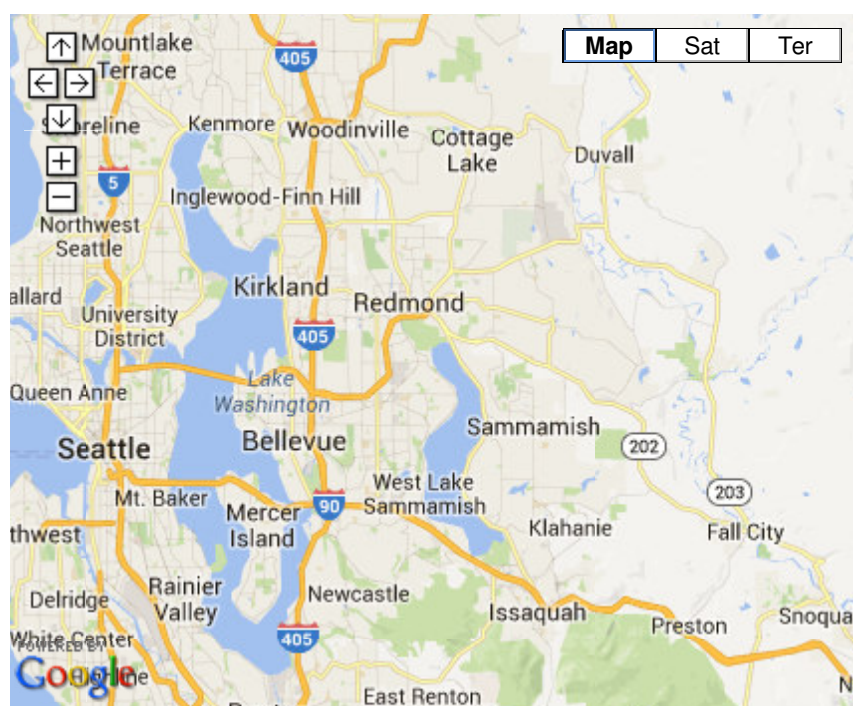

### Needed corridors

What I've just proposed is a pretty decent system by American standards. Of course, it only begins to reach all the areas that ought to be connected to rapid transit. For lacking such access means an incentive to continue driving.

In New York, London and Paris trains have finer grain that is also fast throughout the systems. Whereas in Seattle at present--and for the foreseeable future--only the light rail corridor is fast. Metro and Sound Transit will be relying on buses and streetcars to provide the finer grain coverage.

But light rail (and the unrealized monorail) is necessary because buses are slow and get stuck in traffic. Streetcars are more reliable but tend to be slow due to operating in mixed traffic; according

to Portland's streetcar system plan, the average speed for the just-approved system will be 7-12 mph.

The question then is how an expanded regional light rail system can send rapid transit 'tendrils' out into more of Seattle and urbanized King County -- tendrils that are just as fast as the main lines. This is the niche for podcars.

PRT could be deployed as a complement to light rail, providing **finer grain** that is also fast -- but affordable to construct at \$7-20 million per mile (depending on vendor and routing challenges). This is how PRT is to be used in Sweden and at the Masdar carbon neutral city project (**see Part 4**).

Construction would also be fast due to the small profile of guideway. The elevated portion of the new ULTra podcar system at Heathrow was erected at a rate of two miles per month.

PRT could stretch transit dollars in order to reach more areas that won't be served by commuter or light rail due to density, geography, or budget.

#### PODCARS Series

**Part 1**

**Part 2**

**Part 3**

**Part 4**

**Part 5**

**A few of the many PRT resources on the Internet:**

<http://www.ilsr.org/really-light-rail/>

StarTribune article by David Morris - Institute for Local Self Reliance

<http://gettherefast.org/bettercampus.html> (click on the video icon)

<http://youtube.com/watch?v=B7hgipbHBK8>

collection of 20 ULTra videos - PRT at Heathrow

<http://www.advancedtransit.org/advanced-transit/applications/rivium/>

driverless automated bus system in the Netherlands

[http://www.en.wikipedia.org/wiki/Personal\\_rapid\\_transit](http://www.en.wikipedia.org/wiki/Personal_rapid_transit)

pro and con overview (somewhat out-of-date)

<http://hbswk.edu/item/6333.html>

commentary from Harvard Business School

[http://faculty.washington.edu/jbs/itrans/planetizen\\_article.htm](http://faculty.washington.edu/jbs/itrans/planetizen_article.htm)

[http://faculty.washington.edu/jbs/itrans/big/Goran\\_shortfalls.pdf](http://faculty.washington.edu/jbs/itrans/big/Goran_shortfalls.pdf)

[https://www.youtube.com/watch?v=RI\\_2YgS9JXg](https://www.youtube.com/watch?v=RI_2YgS9JXg)

Ingmar Andreasson - PRT as mass transit

<http://www.prtconsulting.com/content.html>

PRT resource site

<http://www.prtconsulting.com/prtvendorevideos.html>

assorted videos of driverless transit systems

<http://faculty.washington.edu/jbs/itrans/burke.htm>

*Innovation and Public Policy: The Case of Personal Rapid Transit* - book

<http://www.open-spaces.com/article-v3n2-bundy.php>

analysis of transit by a Seattle environmentalist

<http://www.containerstory.com>

how the standardized container industry revolutionized shipping  
(history lesson on technological innovation)

# Really Light Rail

By David Morris

November 14, 1999

*This article originally appeared in the [Star Tribune](#)*

When I was on KTCA's "Almanac" a few months ago with Elwyn Tinklenberg, the transportation commissioner held forth on the promise of light-rail transit (LRT). The cohost anticipated my response.

"Mr. Morris, you're against rail and for buses, right?" She was surprised and confused when I declared my enthusiasm for rail, but for a rail system using technology of the 1990s, not the 1890s.

Her confusion was perfectly understandable. For 25 years the discussion about mass transit has been narrowly framed. That wasn't always the case.

In the 1960s, as automobile use began outpacing the capacity for roads to expand, transportation planners explored a variety of alternatives. Two contrasting approaches emerged.

One was the conventional line haul system of buses and rail, in which stations are located on-line and all passengers must stop when one wants to get off. The other was a new concept, an automated area network, quickly dubbed personal rapid transit or PRT, in which stations were off-line and passengers could go directly to their desired destination. A PRT system is usually elevated. Passengers enter a station off the main line, get on a vehicle and punch in their destination, and the vehicle moves out of the station into the flow of traffic.

The federal government was intrigued by the possibilities of PRT and financed a working model in Morgantown, W.Va. That system, opened in 1972 and still operating, does boast some PRT features, but its overall design looks and acts more like an elevated light-rail system, with large, 20-passenger vehicles and thus a very costly and visually intrusive support structure.

In the early 1970s, the Minnesota Legislature financed an evaluation of PRT. After looking only at the Morgantown system, the state decided it was too expensive. And for the next quarter of a century, PRT disappeared from the Minnesota transportation debate. Line haul, whether buses or rail, was and is deemed the only conceivable alternative to road expansion.

Research in PRT continued, with most of the progress occurring at the University of Minnesota Engineering Department under the direction of Prof. J. Edward Anderson. By the 1980s, Anderson and the university had received five patents for major improvements in PRT. The Anderson system's striking feature is its small vehicles, about the size of a VW bug. Such vehicles allow for a lightweight, inexpensive and visually unobtrusive support structure.

Over the last 20 years, dramatic advances in electronics have made possible a control system far more sophisticated than Morgantown's. That translates into much shorter distances between cars traveling at 30 to 40 miles per hour, which allows very high traffic



volumes during peak hours. The breakthrough of Anderson's system is that one can serve large numbers of passengers while allowing them the privacy of their own cars and direct transportation to their desired destination.

The small vehicle size and inexpensive support structures allows more stations to be added at a small cost, thereby eventually extending the PRT system to within a few blocks of all city residents. Rather than an elevated light-rail system, Anderson's looks like an elevated narrow-gauge road system populated by small cars. Indeed, the very name of his company evokes a visual image of the concept - Taxi 2000.

While PRT in Minnesota was making great strides in engineering design, light-rail systems had captured the fancy of policymakers. More than a dozen have been built. For the most part, they are attractive, popular and well-used. But even LRT's most optimistic advocates concede that they are expensive and do virtually nothing to alleviate congestion.

The proposed Hiawatha line, for example, at a cost of almost \$600 million, may take 2,000 to 3,000 cars off the road by 2010. That is equal to the traffic on one highway lane in an hour and a quarter. Even when the system is fully built out, it might displace no more than a fraction of a percent of all automobile trips. And the cost for each trip could be \$8 to \$10.

A growing number of transportation planners -- realizing that light rail, while attractive, is not a realistic solution to the traffic problem -- are taking another look at PRT, and they like what they see. A series of recent in-depth analyses of PRT systems for the Swedish cities of Gothenburg, Stockholm and Umea came to two remarkable conclusions: First, PRT could potentially displace over 20 percent of all automobile trips. Second, a PRT system potentially could operate at a profit! Which means it could be financed privately.

In this country, Cincinnati is seriously considering a PRT system for its downtown. Closer to home, Rochester's Mayo Clinic is exploring a PRT system to ferry patients and doctors within its extensive medical complex.

Yet in Minnesota, Anderson and the area-network approach to transportation continue to be treated with indifference or worse. Four months after my appearance on "Almanac," Anderson has yet to be given the opportunity even to present his case to either Commissioner Tinklenberg or Metropolitan Council Chairman Ted Mondale. Any reader who wants to explore the alternative personally can see a computer simulation online and get a direct and detailed answer to virtually any question at the company's Web site: [www.taxi2000.com](http://www.taxi2000.com).

After 20 years of trying, and with the lure of \$250 million in federal matching money, it is understandable that Minnesota government officials are eager to do nothing that might delay their quest for a light-rail system. Yet it is unclear whether this needs to be an either-or situation. PRT may complement LRT, or vice versa.

In any case, the potential benefits of Minnesota's investing in a PRT system are enormous, while the potential costs are modest. An LRT system, at best, offers no economic-development spinoffs. But imagine that we were to build the first commercial PRT system here, with its patents owned by the University of Minnesota and with a homegrown company supplying the control software and technical design advice. Could Minnesota become the world center of PRT design and manufacturing? Why not?

According to Anderson, a \$5 million to \$10 million investment would be sufficient to build a small operating system and prove the viability of PRT here in Minnesota. That is small change for transportation budgets. Indeed, last June, Tinklenberg added another line item in the Hiawatha budget - \$31 million for "contingencies." Wouldn't the potential introduction of a less expensive, more attractive rail transportation system be considered a "contingency"?

<http://www.ilsr.org/columns/1999/111499.html>

© Copyright [Institute for Local Self-Reliance](#)

927 15th St. NW, 4th Fl., Washington, DC 20005 Tel: 202-898-1610  
1313 5th St. SE, Minneapolis, MN 55414 Tel: 612-379-3815  
[www.ilsr.org](http://www.ilsr.org)

## Service Effectiveness of PRT vs Collective – Corridor Transport

Martin Lowson

Advanced Transport Systems Ltd and The University Of Bristol

### Summary

A generalised model is used to provide estimates of overall trip times and speed for conventional corridor-collective transport and PRT. The results demonstrate why traditional forms of transport find difficulty providing an effective service in a city. Short separations between stops are required to minimise walk times but on conventional transport this leads to significant reductions in achievable speed because of the need for frequent stops. It is also shown that there is very little benefit in service effectiveness from LRT/APM/Monorail over buses. PRT is immune to these effects. The present calculations typically show a benefit for PRT of a factor of two or greater in trip time over either bus or LRT/APM.

### Introduction

The problems of collective –corridor transport are established. Any corridor can only serve trips which are along that corridor. Collective transport requires both waiting and frequent stops, probably at every stop on the route during peak periods.

PRT systems are projected to have major benefits for city transport because, in contrast to conventional forms of transport, they offer a combination of good accessibility and short trip times. This note seeks to calibrate this projection via numerical calculations.

The model assumed is shown in Figure 1. The corridor transport stops at each of the stops, assumed to serve a square area with side equal to the distance between the stops.

A trip from start at A to destination at B requires:

1. Walk to station      A-C
2. Wait for transport      C-C
3. Stop at every stop      C-D
4. Walk to destination      D-B

“You have to go to a place you don’t want to go to  
to get to a place you don’t want to get to”

The present model involves an estimation of the times taken for each part of the trip.

### 2. Average Speed In-Vehicle

It is of interest to start with the in-vehicle speed for the central part of the trip. The results are shown in Figure 2. They are based on a simple Newton’s Law calculation of the acceleration – deceleration process from stop to stop. It is assumed that acceleration and deceleration occur at 0.1g and that stops are 20 seconds each. These results parallel results given originally in Hamilton and Nance (1969) and Lowson (1999).

Stop to start times on buses, including door opening, passenger alighting and door closing can be as little as 10 seconds. However passenger boarding normally takes rather longer, especially if there is a need to pay fares to the driver. For light rail times very low stop times are less likely to be achieved since the driver has less direct interaction with the boarding process. Measurements on buses over several routes in Cardiff showed that the average stop time was 23 seconds between 9.00 and 12.00. Other measurements in peak periods showed that average stop times increased to over 30 seconds. Thus it is thought that 20 seconds is an acceptable overall figure. But in any case, modest changes in stop time have little effect on average speed compared to the deceleration acceleration process.

Figure 2 shows the average speed achieved for various stop spacings. It can be seen that high maximum speeds are of little benefit if stops are closely spaced. Under these circumstances, the vehicle merely accelerates to the mid point between the stops and then decelerates without reaching its maximum speed. For 250m stop spacings, the average speed achieved is less than 20 kph regardless of handbook maximum speed.

This corresponds to speeds achieved in practice by buses in favourable conditions. Light rail, or other systems such as monorails and Automatic People Movers (APMs), which have a higher maximum speed, will normally use longer stop spacings, reducing accessibility in order to provide higher average trip speed. Even so it can be seen that the average in-vehicle speeds achieved for 1 km stop spacings is still only 40 kph, ie the same as projected for PRT systems such as ULTra.

### **3. Walk and Wait Times**

Average walk time to the station is dependent on size of the area served by the station, which is in turn dependent on the average stop separation. A simple assumption is that the corridor is serving a “grid” city with all roads laid out at right angles. Although not typical of all European Cities, this offers an acceptable approximation for the purposes of the present estimates.

Figure 3 shows this typical case. A walk from any location to the central station will involve a trip N-S and a trip E-W. Consider a trip starting from any point on the diagonal line. The length of any trip from a point on this line to the centre is  $L/2$  where  $L$  is the length of side of the square. But by symmetry since there is exactly the same area on the far side of the line away from the station as on the near side, this line also represents the average trip length.

Thus, the average walk length in a grid route system over a service area of side  $L$  is simply  $L/2$ . If it is assumed that the walk trip has to be made at both the start and end of the journey then the average distance walked is identically equal to the average stop separation  $L$ .

Use of any form of public transport involves a walk at each end of the trip. In typical cases such as shown in Figure 1, the area served by each station can be assumed to be at the centre of gravity of the served area. Thus the average distance from all points in served area at the start to all destination points in the served area at the destination is equal to the station separation. This is an interesting result which applies to a wide range of circumstances; for example, it applies both to grid based and to straight line travel.



Since, under the above fairly general assumptions, the average distance between start and destination is simply the station spacing, the walk required to get to and from the station is an overhead. Although some walks are in the direction of travel, others are in the reverse direction, while half of all walk distance is normal to the direction required. This overhead adds to the average time taken for travel, but not to the distance usefully travelled.

If it assumed that passengers will walk to the downline station where this provides a net benefit in travel time, there is a small modification to the above argument. This is illustrated in the second diagram in Figure 3. Suppose that the blue line indicates the boundary between the locations where it is preferable to walk to the upline or downline stations. Then on the boundary the journey time via either station is the same, either by walk directly to the downline station, or by walk to the upline station and in-vehicle travel to the downline. This can be expressed algebraically as

$$T = (L/2 + x)/W = (L/2 - x)/W + L/V$$

Where  $W$  is the walk speed and  $V$  in the vehicle speed (which should include the effect of stops).

This gives  $x = L/2 \cdot W/V$

The effect is that the area served by any station is displaced upline. Under the present grid city assumptions it can be seen that the additional walk time to be added on for upline passengers is balanced the reduced walk time to be added for the downline. Thus the average walk distance to the station remains the same. However, the area served has been displaced upline by  $x$ . Similar arguments apply to the passengers arriving at the destination, who can choose to get off one stop early. Thus at the destination, the area served is displaced downline by  $x$ . This means that the average distance between origin and destination served by a station pair a distance  $D$  apart increases to  $D + 2x$ , ie to

$$D + LW/V$$

This only makes a small difference to the numerical results, but is included for completeness.

In practice bus or other journeys will use variable spacings so that the relations above will not apply exactly. However, it appears to offers an acceptable first approximation for the walk distance required. Walk times can be found directly from the walk distance by assuming an average walk speed, taken here as 4.8 kph ie 80m/min the average walk speed recommended by the Confederation of Passenger Transport.

In addition to the walk time there is also a wait time. For the present calculations, this has been assumed to be 5 minutes. This would imply a service frequency of 10 minutes, only occasionally provided by conventional transport.

Finally, a typical trip length must be assumed. For the purposes of the present comparisons, this has been taken to be 8 km, corresponding to the average trip length in the UK. As noted above the average separation of origin destination pairs served by stations 8 km apart is equal to  $8 + LV/W$ . The total time is the time taken in-vehicle plus the walk overhead at both ends of the trip, plus the wait time. The average speed is found by dividing total distance by total time as defined.

#### 4. Results Including Walk and Wait

Figures 4A and B give the results of these fuller calculations. The two Figures show results for bus and light rail respectively. For the bus case, an average in-vehicle speed of 30 kph has been assumed. This is a reasonable assumption for achieved in-vehicle speed in a city where the bus is obliged to stop regularly at pedestrian crossings, traffic lights etc. The second case shows the results for a higher speed service assumed here to be 80 kph. This is a somewhat generous figure to represent light rail, monorail or APM. This figure also provides an indication of the possible effects of priority bus lanes, or guided bus, which could provide increases in in-vehicle speed for buses.

The results in both Figures 4 are presented in terms of average speed achieved against stop spacing. The top curve gives the speed achieved in-vehicle, and is essentially a replot of the 30 kph results from Figure 2. At high stop spacings, it is possible to achieve high in-vehicle speeds, approaching the maximum speed of the vehicle being considered. However, the addition of walk and wait elements to the journey reduces overall trip speed considerably.

As might be expected that the best overall speed for the journey is achieved when stop spacings are short and the amount of time spent walking to and from the stop in is minimised. It can be seen that for the bus case this provides an optimum stop spacing of around 0.5 km. This is quite close to the average stop spacings used by buses in city operations, although typically closer stop separations (and thus lower average speeds) will occur in the city centre.

For the Light Rail/APM model, the optimum stop spacings are also found to be around 0.75 km. The higher speed of the vehicle means that a higher proportion of the time is spent in the walk for the optimum case.

However the most striking feature of these graphs is the low average speed achieved, for the bus this is 14.0 kph and for the Light Rail/APM 17.4 kph. This is because the length of time in the walk part of the trip forces the systems to work at short stop spacings for which the in-vehicle speed is of little benefit. The small improvement in average speed offered by the far higher maximum speed of the Light Rail/APM case is striking.<sup>1</sup> It is also noteworthy that these average speeds are virtually identical to the average speeds achieved by cars in peak periods. This speed is achieved on the corridor, which itself only serves a limited proportion of the trips desired. It is not surprising that current forms of public transport have little attraction compared to car transport.

#### 5. Comparison with PRT

Finally these results are compared to a PRT model. ULTra has been taken as the base for this comparison. This operates at a maximum speed of 40 kph. More importantly, it does not have to stop at the stations since, as with all PRT, these are off-line. For ULTra, it has been anticipated that station spacings would be about 0.5 km, but it would be reasonably straightforward to shorten this separation to 0.25 km if required. The same walk time assumptions have been made for PRT as for the previous cases. For ULTra most passengers

---

<sup>1</sup> Doubling maximum speed again to 160 kph (or indeed again to 320 kph) provides no benefit. The maximum achieved overall speed is 17.5 kph.

will have a zero wait time, but a total additional time of 30 seconds to include both wait and boarding has been assumed for the purposes of these calculations.

The comparison is shown in Figure 5. For Bus/LRT these figures correspond to the same data as presented in Figs 4, but now presented in terms of trip time. It can be seen that PRT can typically offer around a halving of average trip time. These calculations refer to uncongested conditions. In congested peak periods the average speed of buses, and cars, will reduce further, while PRT will continue to offer the same level of service.

However the key issue is that the overall trip time for small stop spacings by conventional transport is unacceptably high. Small stop spacings are necessary to provide good accessibility, so that the basic nature of the corridor –collective service leads to major transport inefficiencies.

For bus, and particularly for Light Rail/APM/Monorail there is pressure to choose larger stop spacings to provide shorter trip times at the expense of accessibility. In the case of PRT in-vehicle speed is independent of the stop spacings selected. Thus in areas such as a city centre it is straightforward to provide closer stop spacings for better accessibility with no loss of transport effectiveness in terms of total delivered trip time.

## **Conclusions**

Analysis of the service effectiveness of conventional corridor collective and PRT transport systems using a typical 8 km trip with walk wait and in-vehicle travel has shown that

### *For conventional transport*

1. Achieved in-vehicle travel speeds are controlled by station to station separation.
2. High maximum speeds offer no benefit to in-vehicle speed at the small station spacings necessary to provide good accessibility.
3. Inclusion of representative walk and wait travel times shows that minimum overall trip times are achieved with modest station spacings (0.5-0.75 km).
4. Maximum achieved speed for the complete trip in any case studied was 17.5 kph, little more than buses.
5. Higher speed forms of conventional transport such as Light Rail, APM or monorail offer little benefit over buses.

### *For PRT*

6. A benefit of around a factor of two is provided over the best trip times achievable by conventional corridor-collective transport.
7. Additional improvements in accessibility can be provided via closer station spacing with no penalty in trip time.

## **Acknowledgments**

I would like to thank Jerome Rapin for making measurement of times on buses and Hugh Collis for helpful comments on the draft. This work has been partly supported by the EC under the Cybercar contract and by the EDICT project under the City of Tomorrow program.

## **References**

Hamilton, W.F., and Nance, D.K., (1969) "Systems analysis of urban transportation"  
Scientific American Vol 221 No1 pp19-27  
Lowson, M.V (1999) "Personal Public Transport" Proc Instn Civ Engrs Transp 1999 135  
Aug 139-151

## **Contact**

Martin Lowson  
Advanced Transport Systems Ltd  
5 Brunel Way, Thornbury, Bristol, BS35 3UR England  
martin @atsltd.co.uk  
44 117 1454 414 700



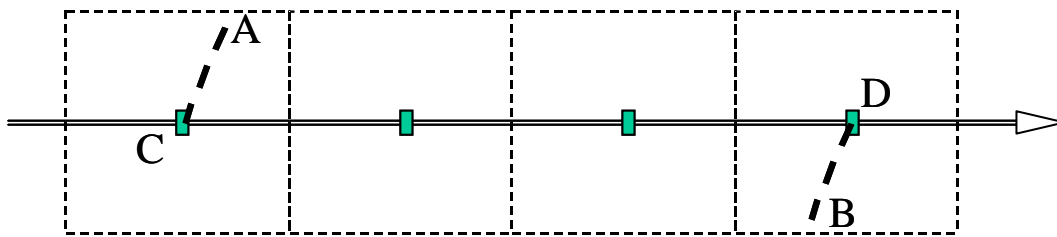

Figure 1 Area Served by Corridor Transport

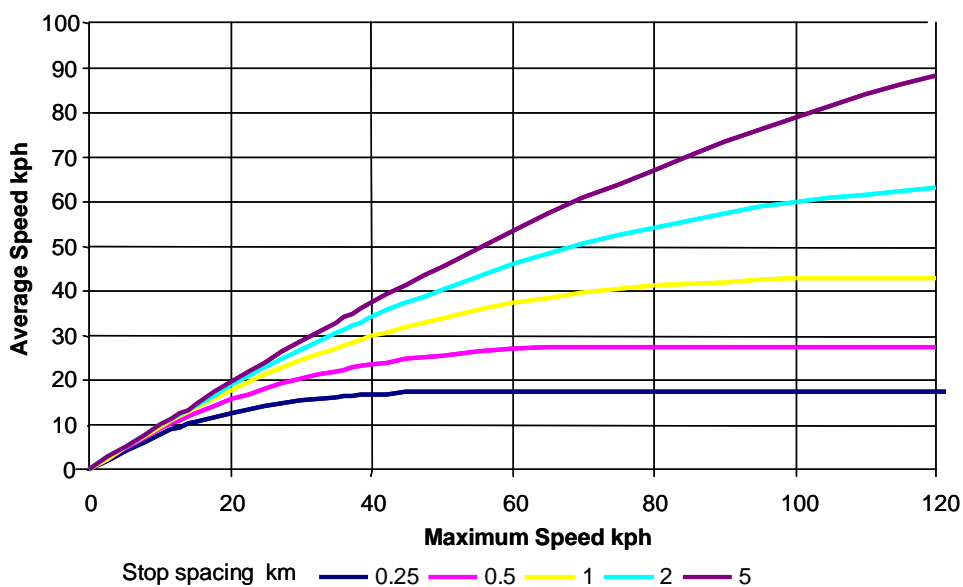

Figure 2 Average Speed in-Vehicle Against Maximum Speed for Various Stop Separations

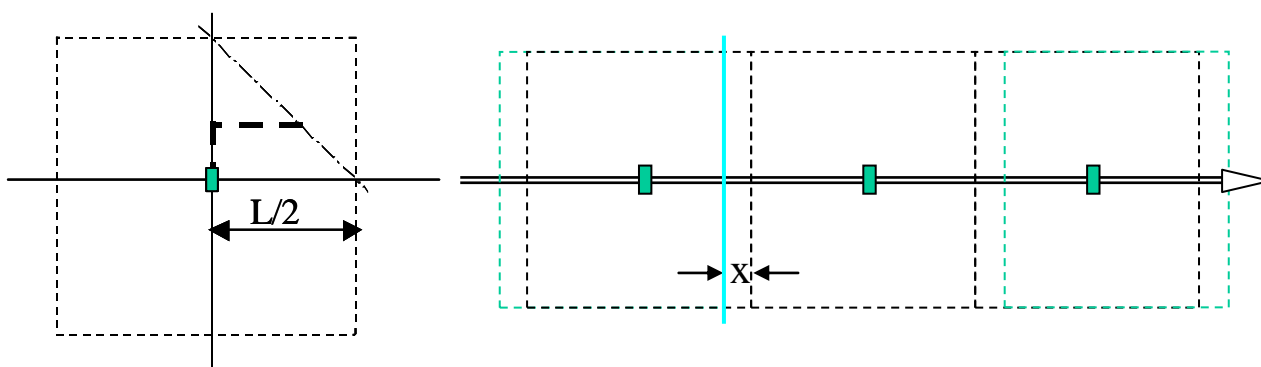
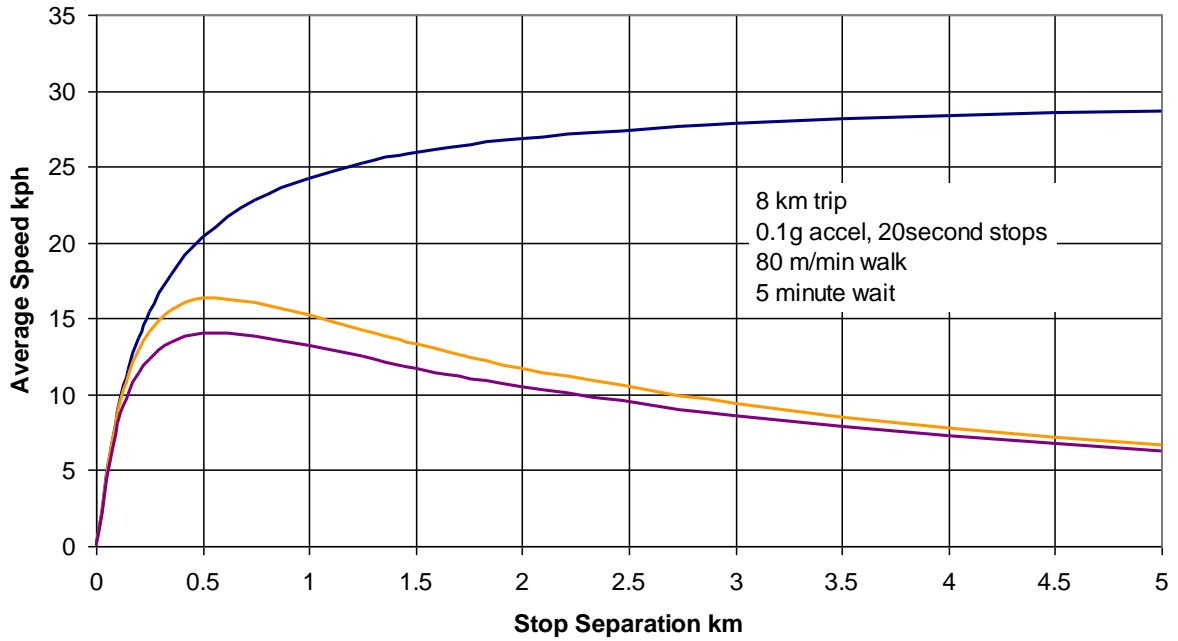

Figure 3 Diagrams showing walk trip length

### Average Speed by Bus (30kph travel speed)



### Average Speed by Light Rail / APM / Monorail (80kph travel speed)

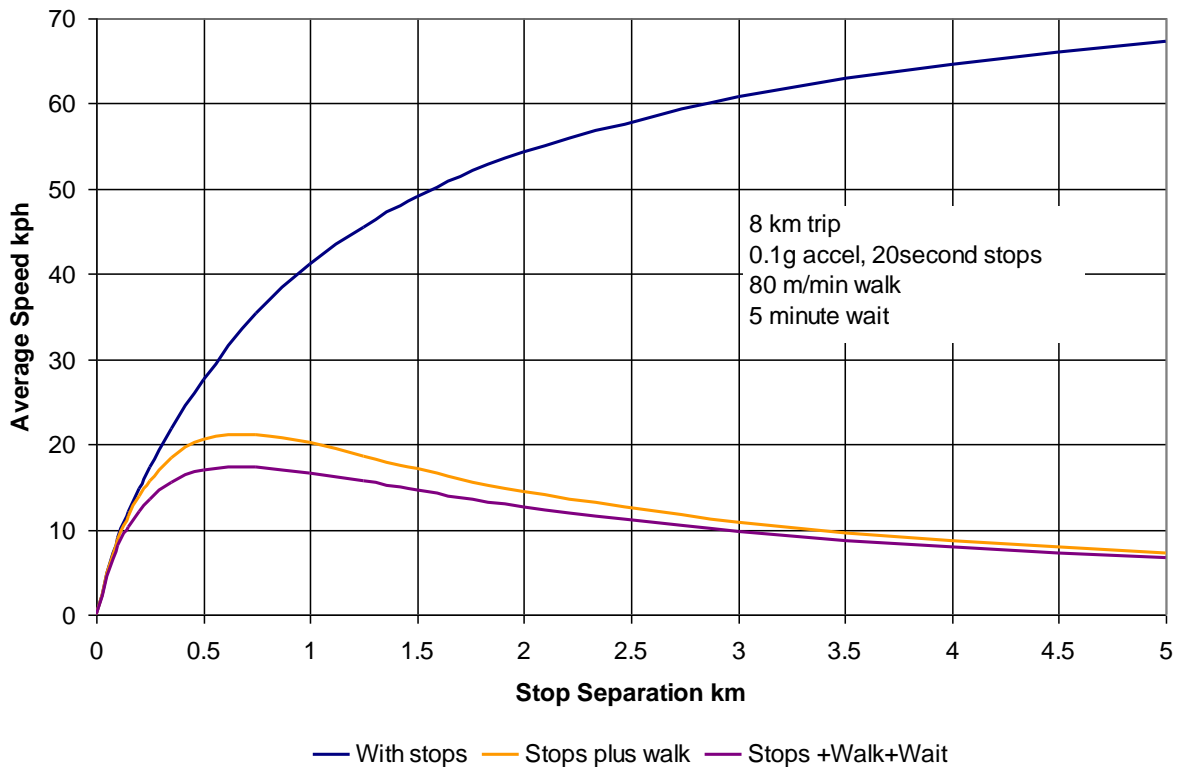
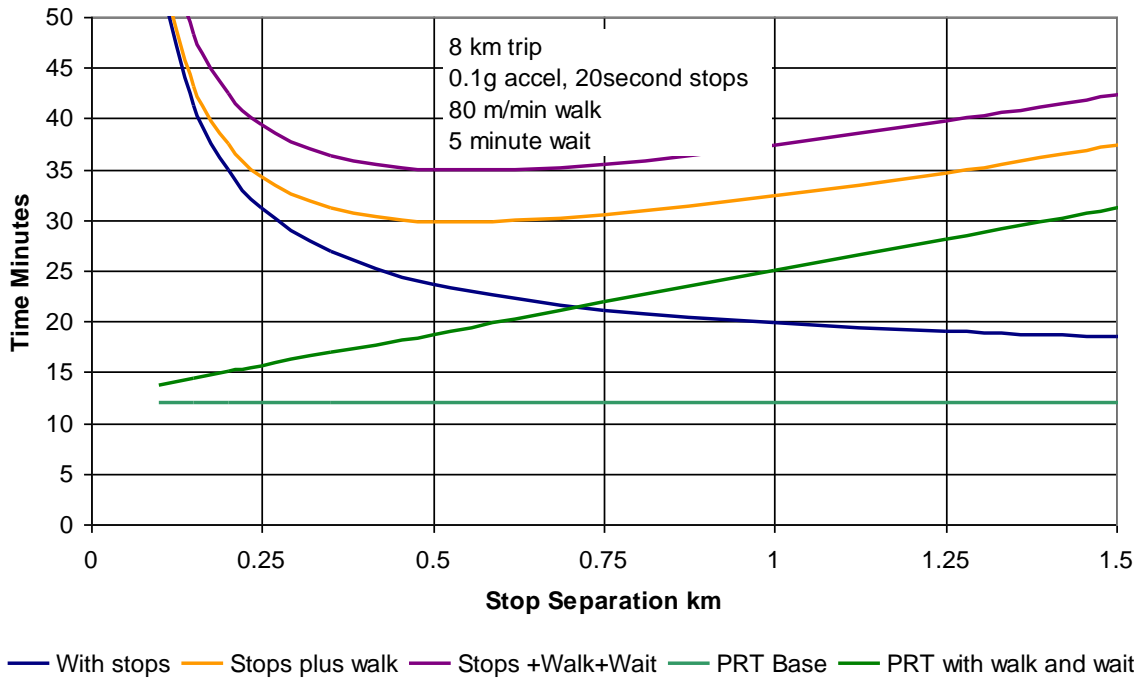

Figure 4 Overall Average Speed for Conventional Transport vs Stop Separation

### Bus Compared to PRT



### LRT/APM Compared to PRT

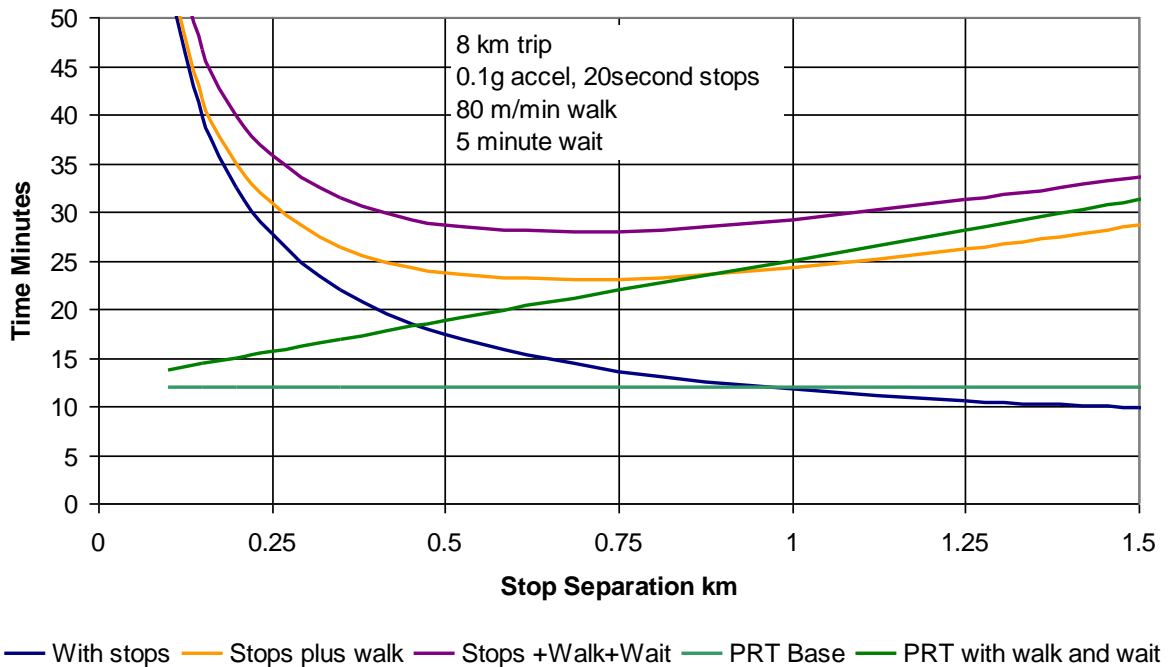

Figure 5 Average Trip Times: PRT Compared to Conventional Transport

# Personal Rapid Transit in Stockholm – Market demand and Economic Appraisal

Author: Mr Göran Tegnér, M. Pol. Sc.  
Business Manager Transportation Studies  
TRANSEK Consultants Company, Solna, Sweden  
Phone: +46-8-735 20 10; Fax: +46-8-735 20 30; e-mail: goran@transek.se

## 1. ABSTRACT

This research project deals with the problem of introducing a potential demonstration-track in the form of a PRT system somewhere in the Stockholm region. The aim of the study is to find an answer to the following main questions:

- i) Which is the best site for such a test-track of a PRT system for Stockholm?
- ii) Which is the most probable demand for such a PRT system, and how much traffic would be diverted from the private car and other modes of transport and how much would be newly generated?
- iii) Which is the economic viability of such a PRT system in Stockholm in terms of user benefits, system costs and overall cost-benefit ratio?

In order to answer these three highly important and interesting questions, the study is divided into the following major parts - a PRT Market Demand Analysis; and a PRT Economic appraisal.

The research results and findings were documented in a research report (in Swedish) by the end of 1998. This paper describes the contents of the project, the methods chosen for the analyses, and the results and research findings.

## 2. Personal Rapid Transit (PRT) – individual trips in public vehicles

Personal Rapid Transit (PRT) offers individual trips in public vehicles – a competitive alternative to the most popular mode of urban transport – the private automobile. PRT is developed to offer some of the advantages of the private auto:

- + It departs on demand without any timetable.
- + It runs the quickest path without any stop and without any transfer.
- + It offers a private trip alone or together with passengers of your own choice.

At the same time one would like to avoid some of the major disadvantages of the private auto:

- Noise and exhausts.
- Congestion and accidents.
- Parking demand.

*PRT is a system of small, automated vehicles on their own guideway that is demand-responsive and offers a direct trip to the destination without any stop en route.*

The PRT solution with many small vehicles can be derived from many different perspectives:

- The trip maker should not wait for the vehicle to come – the vehicle should wait for the passenger
- If one does not force several passengers to travel together, there is no need for large vehicles. The load will resemble that of a taxicab.
- The track should not be larger or more expensive than what is needed. The track cost increases with the weight of the vehicle. One has to distribute the weight. A car with 4 passengers every second gives the same capacity as a traditional train every 15-minute with 1,800 seats.
- The stations should be short. This will be possible with a constant turnover of vehicles and travelers, i.e. dense departures with small vehicles.
- If the vehicle is driven automatically, the only reason for large-scale vehicles falls short. The passenger service governs the traffic performance, not the driver cost. Small vehicles demands a very dense traffic, which means that vehicles are not allowed to stop for boarding and alighting on the main track from capacity reasons. Also, unnecessary stops for service reasons should be avoided. Therefore, all PRT systems are designed with stations located on sidetracks.
- Short time slots between vehicles do not allow switches on the track; this would be too time-consuming. Instead the vehicle chooses its route through fixed switches.



- Acceleration and deceleration does not allow standing passengers. Therefore the system is designed to carry seated passengers only. Guaranteed seating capacity also contributes to the attractiveness of the system. Wheel-chair passengers are foreseen to be able to travel in all PRT-vehicles.
- A PRT ride without a stop between origin and destination station is not only comfortable and convenient. The energy consumption is less than one fourth of that of an automobile.

### 3. The long-term evolution of auto and transit traffic

Transek Consultants was commissioned by the Regional Planning and Urban Transportation Office, Stockholm County Council to investigate the long-term evolution of auto and transit traffic (Ref. 1, 2, 3 and 4). The estimated auto traffic production in terms of vehicle-kilometers has increased by 88 % between 1970 and 1995 or by 2,5 % annually. The corresponding transit ridership, estimated through ticket sales records, is estimated to have increased by 18 % or by 0,7 % annually between 1973 and 1997. The imbalance of modal development, both in the retrospective and in the forthcoming period is shown below:

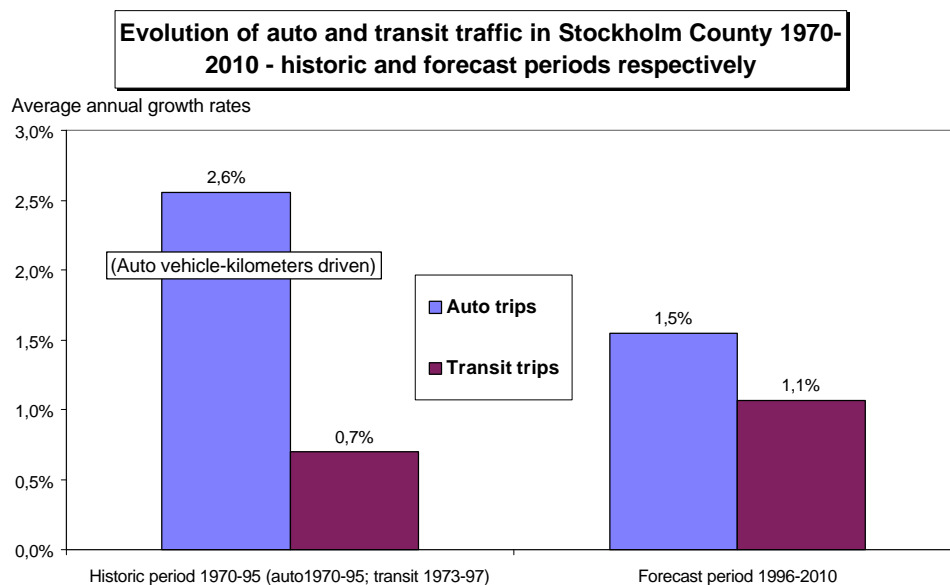

Our conclusion from this observation is that the present type of transit systems (bus, metro and commuter rail) is insufficient in its performance to attract new travelers to cope with the self-service system of the automobile. There is a strong need for a high-quality performance transit system – such as PRT – if the urban transportation problems of too low efficiency, too high accident rates and environmental air pollution should be curbed.

## 4. PRT in Stockholm – an efficient and sustainable transport system

The purpose of this chapter is to illustrate the *area-wide* potential of a high-level-of-service transit system in terms of generalized travel times and market shares – in comparison to the more traditional transit modes, such as bus, commuter rail and subway. A second purpose of this exercise is to form a basis for the selection of the best site for a PRT demonstration track in the Stockholm Region. Therefore, a PRT trip demand analysis has been carried out for the entire Stockholm County Area (population; 1,775,000 inhabitants in 1998), with the simplified assumption that a PRT-station would be (theoretically) available in every traffic zone (1,043 zones) and running on the present major road links in the network. The existing transit modes are assumed to prevail. The demand procedure is summarised in figure 2.

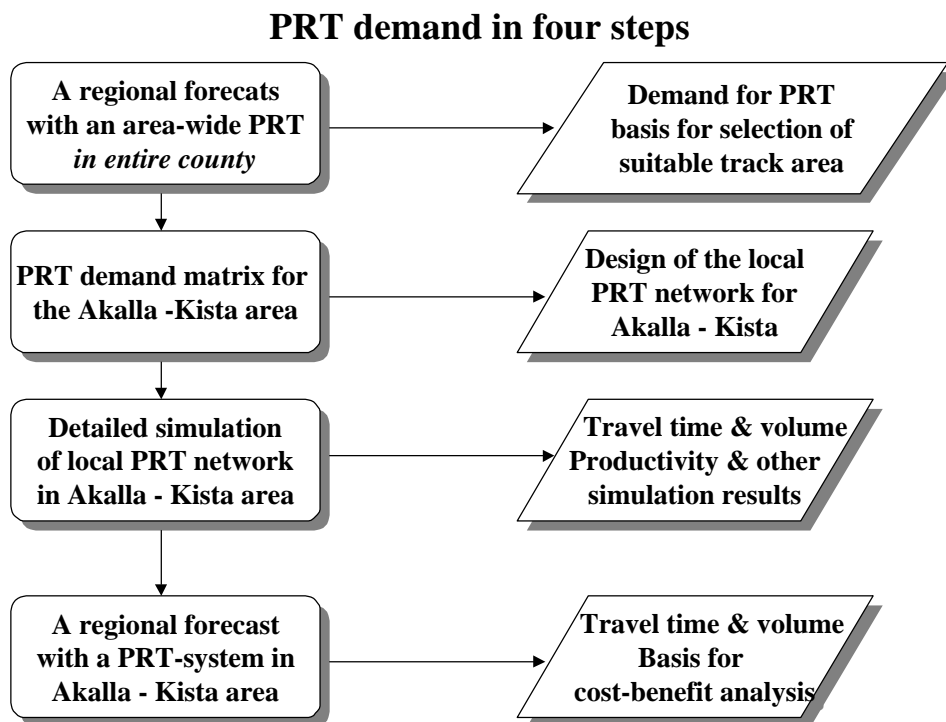

This formed a basis for considerations of the best suitable location for a PRT demonstration track.

The major changes in the generalized travel times that could be achieved by the PRT system, are mostly a dramatic reduction in the waiting and transfer times, compared to the present day modes of mass transit.

As the PRT system operates as an automated and a demand responsive system, the time spent waiting for the vehicles, does not differ at all between peak and off-peak time periods; this being the opposite for today's manually driven fixed line service. Thus, the major travel time gains with PRT will occur during the off-peak period. The weighted generalized time<sup>1</sup> is calculated to be reduced from almost one hour (55 minutes) in the base scenario to a little more than a half-hour in the PRT scenario. (Figure 3)

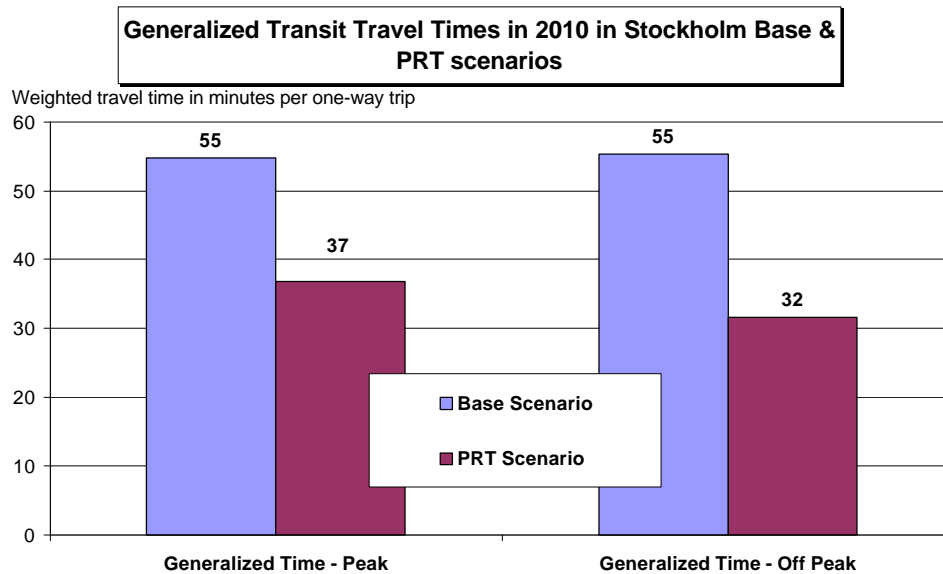

If an *area-wide PRT system* would be introduced in all Stockholm region, a substantial modal shift from the auto mode (-4 % units) would occur; also a slight shift from the walk and bike modes towards the transit modes, including the new area-wide PRT-system.

---

<sup>1</sup> The weights are 2 for the walk, wait and transfer travel time and 1 for the in-vehicle travel time (see Reference 6).

The transit modal split is estimated to augment from 46 to 52 % by the new PRT system, i.e. a 13 % growth in market share:

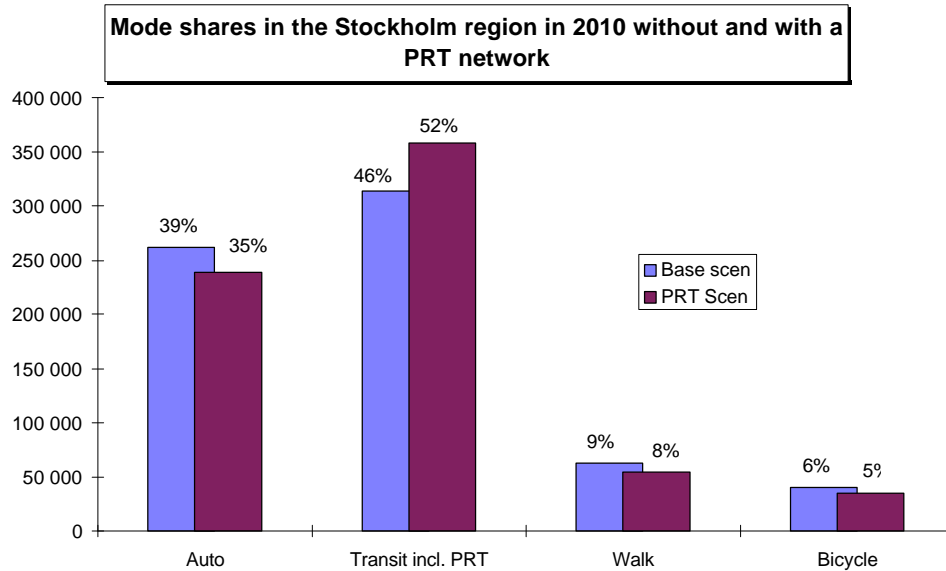

The number of auto trips is calculated to be reduced by 9 % in the peak period, with its dramatic and positive impacts in terms of reduced congestion, air pollution and road traffic accidents. Transit trips – including the new PRT mode – is forecast to expand by almost one third (31%) during all day, and by 41 % in the off-peak period:

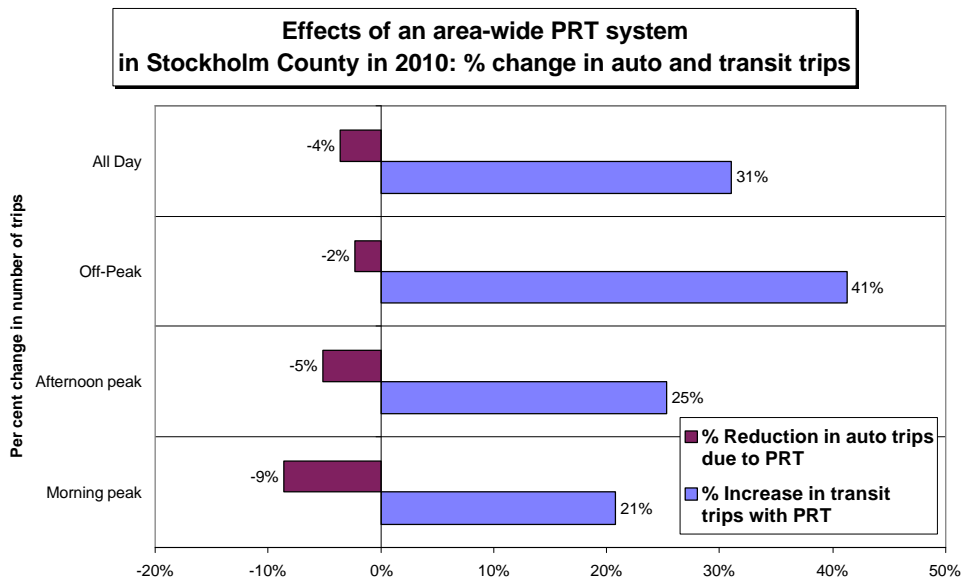

## 5. The demand for PRT-trips in the Akalla – Kista area

The choice of the most suitable location for a potential PRT demonstration track is based on at least six various criteria:

- Areas (in fact origin-destination pairs) with a generalized time elasticity with respect to the demand for transit trips(numerically) above  $-2.0$  and a minimum number of transit trips
- Areas with a travel time relationship between the transit and auto mode of three or more and a minimum number of transit trips
- Areas with an even distribution of peak and off-peak trips and a minimum number of transit trips
- Areas with a high traffic load and a minimum number of transit trips
- Areas with a high load of estimated PRT trips per track-kilometer
- Robust areas with a combination of high densities in the number of:
  - Occupied residents per square kilometer
  - Work-places per square kilometer
  - Household income potential per square kilometer
  - Privately owned automobiles per square kilometer.

Maybe, the most important criteria above all, are the support from local authorities. By coincidence, most of the areas selected according to the above mentioned six criteria, are also preferred locations by the local municipalities:

- Handen Center
- Järfälla-Kista-Akalla-Häggvik
- Karolinska Institute & Hospital-Solna-Sundbyberg
- Sigtuna - Arlanda - Märsta
- Skärholmen-Kungens kurva-Huddinge C-Huddinge Hospital
- Södertälje Centre
- Upplands-Väsby

A corridor from the cities of Sundbyberg – Solna – Karolinska and the northwestern part of the inner city have been excluded due to political and visual intrusion points of view.



The major results for the studied PRT network alternatives are shown below

<b>Indicator/ Network alternative</b>	<b>Kista</b>	<b>Kista- Helenelund</b>	<b>Akalla-Husby- Kista</b>	<b>Akalla-Husby- Kista- Helenelund</b>	<b>Akalla-Husby- Kista- Helenelund- Sollentuna C</b>
Track length, km	9	11	18	20	28
Number of stations	9	10	19	20	26
Vehicle fleet size	31	38	82	121	275
PRT Trips per day	2 750	3 460	6 125	7 460	12 735
Daily trips per track km	305	315	340	375	455
Average trip length in peak	2,3 km	2,6 km	3,0 km	3,6 km	5,8 km
Average trip time in peak	4,1 min	4,6 min	5,2 min	6,1 min	9,9 min

The structure of the entire network examined is shown below:

The PRT networkfor Akalla-Kista-Helenelund-Sollentuna C

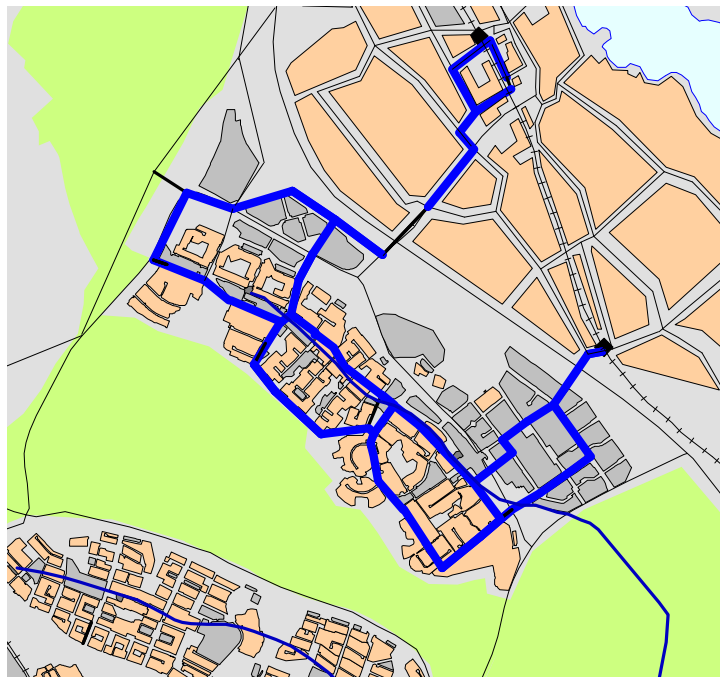

The results indicate that the number of daily trips per track-kilometer increases as the network size augments from 9 to 28 kilometers. This is an indicator of the cost-benefit ratio, as the number of trips is associated with user benefits, and track size with its costs.

## 6. A Stated Preference Study on PRT comfort and convenience

A Stated Preference survey was carried out with the aim to investigate the willingness to pay for PRT comfort and convenience factors, such as:

- In-vehicle travel time with PRT
- PRT headway
- In-vehicle travel time with bus
- Bus headway

In all 162 persons were interviewed in the Barkarby – Kista area in the northwestern suburbs of Stockholm, of which 50 % were auto drivers and 50 % transit users.

- The result for the onboard travel time as well as for the trip frequency (or headway) showed *no significant* deviation in the travel time component value for a PRT trip compared to a bus trip.
- To have *manned stations* - instead of unmanned stations – has a very high value, 0.50 US\$ per trip, reflecting the insecurity of today's mostly unmanned metro and rail stations in Stockholm.
- Travelling 5 meter above the surface with a PRT vehicle, is shown to have a slight negative value of -7 cents per trip.

Besides, the following types of *attitudinal* questions also revealed some interesting results:

- On the question: "I am uninterested in PRT, as it has a negative visual intrusion (makes the city look more ugly)", only 25 % agreed. Therefore, visual intrusion does not seem to be a major drawback for PRT.
- On the question: "I am uninterested in travelling by PRT if I have to share my trip with other passengers in peak hours", only 13 % seem to think this might be any problem. More than two thirds of the respondents denied this would be a problem.
- Of all respondents, about half of them felt insecure travelling in a driver-less vehicle, of which 15 % had a very strong expression against it; while 30 % declared this was no problem. This shows there is a need for more information to the customers of this new kind of driver-less transit service (which is not in operation anywhere in Sweden so far). Professor Elsa Rosenblad's focus group interviews in Gothenburg show that this fears for automation disappears after a proper information about it (Ref. 5).
- On the question: "I feel unsafe travelling 5 meters above the ground", only 20 % confirmed this negative statement. As many as 60 % expressed their view, this was no problem to them. As the average monetary value was slightly negative, we conclude that there is a minority with a very strong negative feeling for going elevated (there is no such transit system in Sweden except for ski lifts).

- The last question was “If a PRT system would be built between Barkarby and Kista, how often could you imagine to go with it”? Almost 65 % or two-thirds could imagine going by PRT regularly or sometimes and only 16 % answered ‘seldom’ and just 3 % said ‘never’. These positive results are well in accordance with the research findings from Professor Elsa Rosenblad’s study in Gothenburg (Ref. 5).

## **7. A Cost-benefit Analysis of a PRT network in the Akalla-Kista Area**

Several cost-benefit analyses have been carried out for the five various PRT-networks (described in section 4 above). Our findings reveal that the best cost recovery is obtained for the largest PRT network, i.e. the Akalla-Husby-Kista-Helenlund-Sollentuna network.

Investment cost data were obtained from Raytheon’s PRT2000, and from two conceptual Swedish systems - Swedetrack’s FlyWay (a suspended PRT system) and SkyCab (a supported system). A high (0,24 US\$) and a low (0,17 US\$) operating cost per passenger-kilometer is also associated with the US PRT2000 and the two Swedish conceptual systems, respectively.

The analysis is carried out over the calculated economic lifetime of the PRT project, 60 years. In our recommended cost-benefit analysis procedure, we consider higher values of time, comfort, safety and environmental impacts over the total time span for the project. This is related to the assumed average long-term economic growth rate of 1-2 % annually (GNP or household disposable income per capita). A present value and related annuity benefits and costs are then calculated.

As a consequence of these assumptions, the first year’s benefits from the PRT project will increase over time due to the fact that the travelers will evaluate the benefits at a higher value each year, as prosperity grows in the future years to come. As a sensitivity analysis we have also calculated the benefits without an adjustment of the behavioral values over time (not presented in this paper). The table below shows that a PRT demonstration network in the presented Akalla – Husby – Kista –Helenelund – Sollentuna area of Stockholm would be economically viable and well justified in the low cost alternative. The cost-benefit ratio is calculated to be 1,5, which means that one dollar spent on PRT in this area yields one dollar and 50 cents in total benefits. Even the more expensive Raytheon PRT 2000 system would yield 70 cents per spent US dollar at its full-calculated price.

With a 25 % reduction (covering engineering, construction, management, administration, start-up and testing<sup>2</sup>), also the PRT 2000 system would balance benefits and costs (benefit-cost ratio equals 1,0).

**Summary result: Benefit – Cost Analysis of PRT in Akalla-Kista-Helenelund-Sollentuna**

<b>Cost item;</b>	<b>FlyWay</b>	<b>PRT 2000</b>	<b>PRT 2000</b>
<b>Annual Costs, MSEK<sup>3</sup></b>			<b>(less 25% overhead)</b>
Capitalized Investment costs	63 (investment: 1,885)	152 (investment: 3,428)	116 (investment: 2,628)
Annual Operating costs	81	133	106
Cost of public capital; shadow price	33	65	51
VAT tax burden	53	105	82
<b>TOTAL ANNUAL COSTS</b>	<b>230</b>	<b>455</b>	<b>355</b>
<b>Benefit item;</b>	<b>FlyWay</b>	<b>PRT 2000</b>	<b>PRT 2000</b>
<b>Annual Benefits, MSEK<sup>4</sup></b>			<b>(less 25% overhead)</b>
Transit travel time gains, incl. .PRT	178	178	178
Ticket revenues, incl. less public capital	26	26	26
Traffic safety gains from less auto trips	48	48	48
PRT Comfort & Convenience gains	42	42	42
Less congestion due to less auto traffic	21	21	21
Health and Environmental gains	24	24	24
<b>TOTAL ANNUAL BENEFITS</b>	<b>339</b>	<b>339</b>	<b>339</b>
NET BENEFITS (Benefits – Costs)	109	-116	- 16
<b>BENEFIT/COST ratio</b>	<b>1,5</b>	<b>0,7</b>	<b>1,0</b>

A PRT System in the Akalla - Kista area of Stockholm would yield a wide range of positive and desired impacts:

- Travel time and comfort and convenience gains for PRT users
- A modal shift from auto to transit (including PRT) modes of transport
- Traffic safety gains
- Eased congestion from less auto traffic
- Health and environmental gains.

<sup>2</sup> These figures are based on the SeaTac study: Personal Rapid Transit (PRT) Feasibility Project-Executive Summary and Technical Appendices, City of SeaTac, August 1997)

<sup>3</sup> One million Swedish Crowns roughly corresponds to 125,000 US\$ (exchange rate 1 SEK = 0,13 US \$)

<sup>4</sup> One million Swedish Crowns roughly corresponds to 125,000 US\$ (exchange rate 1 SEK = 0,13 US \$)

From the analysis, one could estimate the maximum investment cost per system-kilometer for a PRT network of the relevant size to be about 115 MSEK/km (corresponding to 15 million US\$ per track-kilometer). The desired minimum peak load should amount at least 500 passengers per peak hour and track-kilometer.

From our area wide PRT demand study (section 3 above), we have indicators of the cost-benefit ratio for 14 potential areas within the Stockholm region. As a rough estimate we have used the number of daily trips per track-kilometer. Bearing in mind, that this is just a crude indicator of economic viability, one could however conclude that there might be at least six potential areas, with an even higher possible return in terms of social net benefits over costs:

These areas are in order of cost-benefit ratio:

- Odenplan - Karolinska Institutue & Hospital - Solna
- Bergshamra - University of Stockholm - Odenplan
- Solna Center – Sundbyberg
- Solna Center - Bergshamra
- Barkarby – Akalla.
- Södertälje C

Our recommendation is therefore clear – a PRT system for Stockholm provides such a broad range of desired qualities, that it should be given highest priority in research, development, testing and demonstration for implementation in the Stockholm Metropolitan area.



## 8. References

- 1 Tegnér, G. ; Loncar-Lucassi, V., (1997) "Demand for Road Use, Accidents and their Gravity in Stockholm: Measurement and analysis of the Dennis Package". Transek AB, Stockholm, 18 p.
- 2 Tegnér, G.; Loncar-Lucassi, V. (1997) "Time-series Models for Urban Road Traffic and Accidents in Stockholm". Paper presented at the Aalborg University, Denmark.
- 3 Tegnér, Göran B., Loncar-Lucassi, Vesna M. (1997): "An Analysis of Urban Road Traffic Safety in Stockholm - The use of aggregate time-series models with the TRIO programme". Proceedings, the European Transport Forum Annual Meeting, 1-5 Sept, 1997, London.
- 4 Tegnér, G; Loncar-Lucassi, v; Nilsson, C., TRANSEK Consultants; and Holmberg, I., Gothenburg University, Department of Statistics, School of Economics and Commercial law, (1998) "The Demand for Public Transport Trips in Stockholm County – a two-stage aggregate, non-linear time-series model. Paper presented at for Economics and Institutions of Transport, May 25<sup>th</sup> - 27<sup>th</sup>, 1998, Borlänge, Sweden.
- 5 Rosenblad, E., (1997) "Spårtaxiresenärer – brukares möte med ny teknik", (in Swedish), CTH Rapport 1997:10, Chalmers Tekniska Högskola, Göteborg, Sweden
- 6 Tegnér, G., (1997) "Market Demand and Social Benefits of a PRT System: A Model Evaluation for the City of Umeå, Sweden". Infrastructure, Vol. 2, No. 3, pp. 27-32, 1997, John Wiley & Sons, Inc.