

Final Report

# Regional Drinking Water Supply, Groundwater Recharge and Stormwater Capture and Reuse Study

## Southeast Metro Study Area

April 2016

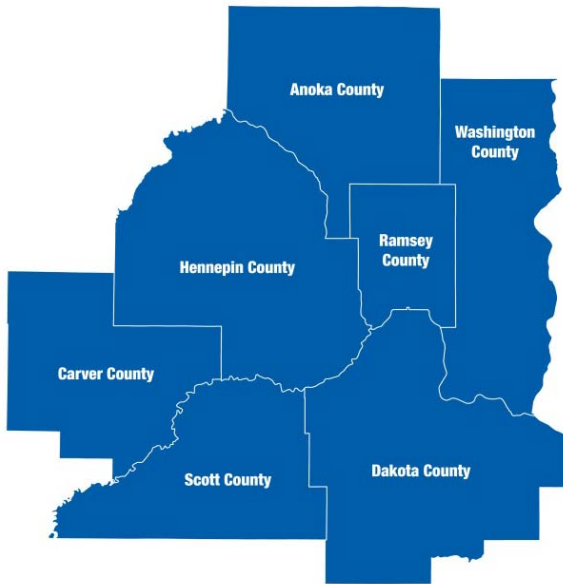


**This page intentionally left blank**

# The Council’s mission is to foster efficient and economic growth for a prosperous metropolitan region.

## Metropolitan Council Members

Adam Duinick	Chair	Edward Reynoso	District 9
Katie Rodriguez	District 1	Marie McCarthy	District 10
Lona Schreiber	District 2	Sandy Rummel	District 11
Jennifer Munt	District 3	Harry Melander	District 12
Deb Barber	District 4	Richard Kramer	District 13
Steve Elkins	District 5	Jon Commers	District 14
Gail Dorfman	District 6	Steven T. Chávez	District 15
Gary L. Cunningham	District 7	Wendy Wulff	District 16
Cara Letofsky	District 8		



The Metropolitan Council is the regional planning organization for the seven-county Twin Cities area. The Council operates the regional bus and rail system, collects and treats wastewater, coordinates regional water resources, plans and helps fund regional parks, and administers federal funds that provide housing opportunities for low- and moderate-income individuals and families. The 17-member Council board is appointed by and serves at the pleasure of the governor.

This publication printed on recycled paper.

On request, this publication will be made available in alternative formats to people with disabilities. Call Metropolitan Council information at 651-602-1140 or TTY 651-291-0904.

## About this Report

The 2005 Minnesota Legislature directed the Metropolitan Council to “carry out planning activities addressing the water supply needs of the metropolitan area,” including the development of a Twin Cities Metropolitan Area Master Water Supply Plan (Minn. Stat., Sec. 473.1565). After completing that plan, the Council took on many technical and outreach projects that strengthen local and regional water supply planning efforts. These projects have also elevated the importance of water supply in local comprehensive planning, which is carried out by local communities.

This study is one of several being led by the Metropolitan Council to support an update to the Master Plan and other activities identified by the 2005 Minnesota Legislature to address the water supply needs of the seven-county metropolitan area. This study is funded from the Clean Water Legacy Fund (Minn. Laws 2013 Ch. 137, Art. 2, Sec. 9).

The Metropolitan Council retained HDR, Inc. to complete this technical assessment of the capital and operational costs, as well as the potential benefits, of three broad approaches to the regional sustainability of water resources in the northern portion of Dakota County. This study has been carried out with input from and engagement with local stakeholders, including municipalities, public water utilities, Empire Township and Dakota County through a water supply work group. This group continues to meet regularly to discuss the study along with other water supply topics of importance to group members.



## Recommended Citation

Metropolitan Council. 2016. *Regional Water Supply, Groundwater Recharge and Stormwater Reuse Study (Southeast Metro Study Area)*. Prepared by HDR Engineering, Inc. Metropolitan Council: Saint Paul.

## Table of Contents

About this Report.....	ii
Recommended Citation.....	ii
Executive Summary .....	viii
Background.....	viii
Drinking Water Supply .....	viii
Enhanced Recharge .....	ix
Stormwater Capture and Reuse .....	x
Wastewater Reuse .....	x
Regional Implementation Planning .....	x
Related Water Planning Efforts .....	x
Introduction.....	1
Background .....	1
Drinking Water Supply.....	2
Demand Projections .....	2
Existing System Descriptions .....	4
Resource Evaluation.....	4
Drinking Water Supply Scenarios .....	15
Costs.....	23
Water Quality Considerations Associated with Water Supply Scenarios.....	34
Enhanced Recharge.....	41
Introduction .....	41
Recharge and Infiltration.....	41
Benefits of Enhanced Groundwater Recharge .....	42
Methodology .....	42
Results.....	43
Enhanced Groundwater Recharge Implementation.....	45
Stormwater Capture and Reuse .....	50
Introduction .....	50
Methodology .....	50
Results.....	51
Stormwater Capture and Reuse Implementation.....	54

Stormwater Capture and Reuse System Components .....	54
Stormwater Capture and Reuse Project Development.....	55
Examples of Local Stormwater Capture and Use Systems .....	60
Wastewater Reuse .....	62
Regional Implementation Planning.....	62
Glossary .....	63
Acronyms and Short Forms.....	66
References .....	68

### List of Charts

Chart 1. Monthly Distribution of Annual Demands .....	5
Chart 2. Annual Shortages at Fort Snelling Gage (Current and Year 2040 Demands, $Q_{90}$ Minimum Flows).....	9
Chart 3. Annual Shortages at St. Paul Gage (Current and Year 2040 Demands, $Q_{90}$ Minimum Flows) .....	12
Chart 4. Enhanced Recharge Project Implementation Phases and Associated Costs .....	46

### List of Tables

Table 1. Southeast Metro Study Area Population and Water Demand Projections Summary.....	3
Table 2. Southeast Metro Study Area Water System Summary .....	4
Table 3. Average Monthly and Total Annual Demands for the Southeast Metro Study Area .....	6
Table 4. Select Drought Shortage Statistics at Fort Snelling Gage (Current Year 2010 Demands, $Q_{90}$ Minimum Flows).....	7
Table 5. Select Drought Shortage Statistics at Fort Snelling Gage (Year 2040 Demands, $Q_{90}$ Minimum Flows).....	8
Table 6. Select Drought Shortage Statistics at St. Paul Gage (Current Demands, $Q_{90}$ Minimum Flows) .....	10
Table 7. Select Drought Shortage Statistics at St. Paul Gage (Year 2040 Demands, $Q_{90}$ Minimum Flows).....	11
Table 8. Drinking Water Supply Scenarios .....	17
Table 9. Continued Development of Groundwater Sources Scenarios .....	18
Table 10. Surface Water Scenario 1 Pipe Segments .....	19
Table 11. Surface Water Scenario 2 Pipe Segments .....	20
Table 12. Surface Water Scenario 3 Pipe Segments .....	21
Table 13. Surface Water Scenario 4 Pipe Segments .....	21
Table 14. Surface Water Scenario 5 Pipe Segments .....	22
Table 15. Surface Water Scenario 6 Pipe Segments .....	22

Table 16. Surface Water Scenario 7 Pipe Segments .....	23
Table 17. Groundwater Scenario 1 Costs .....	25
Table 18. Groundwater Scenario 2 Costs .....	26
Table 19. Surface Water Scenario 1 Costs .....	27
Table 20. Surface Water Scenario 2 Costs .....	28
Table 21. Surface Water Scenario 3 Costs .....	29
Table 22. Surface Water Scenario 4 Costs .....	30
Table 23. Surface Water Scenario 5 Costs .....	31
Table 24. Surface Water Scenario 6 Costs .....	32
Table 25. Surface Water Scenario 7 Costs .....	33
Table 26. Summary of Annual Costs for Drinking Water Supply Scenarios .....	34
Table 27. Water Quality Summary for the Mississippi and Minnesota River Systems.....	35
Table 28. Southeast Metro Study Area Water Supply and Treatment Practices .....	36
Table 29. Corrosion Scale Indices Key .....	39
Table 30. Corrosion/Scaling Indices for Regional Water Supplies .....	40
Table 31. Corrosion/Scaling Indices After 50:50 Blend of Groundwater with Surface Water .....	40
Table 32. Tier 1 and Tier 2 Areas in the Study Area for Enhanced Recharge Using All Criteria .....	44
Table 33. Tier 1 and Tier 2 Areas for Enhanced Recharge in Municipalities Using All Criteria .....	44
Table 34. Tier 1 and Tier 2 Areas for Enhanced Recharge in Watersheds Using All Criteria.....	45
Table 35. Estimated Capital Cost for Recharge basins .....	49
Table 36. Summary of Stormwater Runoff and Groundwater Use within the Southeast Metro Study Area .....	52
Table 37. 2010 High-Volume Urban Irrigation Uses within the Southeast Metro Study Area .....	52
Table 38. Potential Sites for Captured Stormwater Use in the Southeast Metro Study Area .....	53
Table 39. Site-Specific Comparison of Run-on with Irrigation Use .....	53
Table 40. Table of Potential Groundwater Offsets versus Annual Run-on .....	54
Table 41 Concentrations of Stormwater Constituents .....	56
Table 42. Summary of State of Minnesota Water Quality Guidelines for Irrigation.....	57
Table 43. Summary of Potential Permitting Requirements for Stormwater Use Projects .....	58
Table 44. Conceptual Cost for Stormwater Capture and Reuse Systems .....	59

## List of Figures

Figure 1: Southeast Metro Study Area

Figure 2: Surface Water Diversion Sites/USGS Stream Gages

Figure 3: Collector Well Schematic

Figure 4: Collector Well Evaluation

Figure 5: 20% Reduction: 2040 Model-projected Drawdown/Recovery

Figure 6: 2040 Model-projected Drawdown/Recovery

Figure 7: Surface Water Scenario 1: 42 MGD Minnesota River Supply

Figure 8: Scenario 1: 2040 Model-projected Drawdown/Recovery

Figure 9: Surface Water Scenario 2: 50 MGD Minnesota River Supply

Figure 10: Scenario 2: 2040 Model-projected Drawdown/Recovery

Figure 11: Surface Water Scenario 3: 40 MGD Minnesota River Supply

Figure 12: Scenario 3: 2040 Model-projected Drawdown/Recovery

Figure 13: Surface Water Scenario 4: 60 MGD Minnesota River Supply

Figure 14: Scenario 4: 2040 Model-projected Drawdown/Recovery

Figure 15: Surface Water Scenario 5: 17 MGD Mississippi River Supply

Figure 16: Scenario 5: 2040 Model-projected Drawdown/Recovery

Figure 17: Surface Water Scenario 6: 50 MGD Mississippi River Supply

Figure 18: Scenario 6: 2040 Model-projected Drawdown/Recovery

Figure 19: Surface Water Scenario 7: 135 MGD Mississippi River Supply

Figure 20: Scenario 7: 2040 Model-projected Drawdown/Recovery

Figure 21: Potential Areas for Enhanced Recharge to Bedrock Drinking Water Aquifers (Hydrogeological Criteria)

Figure 22: Potential Areas for Enhanced Recharge to Bedrock Drinking Water Aquifers (All Criteria)

Figure 23: Enhanced Recharge Areas within Watershed Jurisdictions

Figure 24: 2040 Model-projected Drawdown and Recharge Areas



Figure 25: 2010 Land Use

Figure 26: Modeled Sites for Stormwater Reuse

### **List of Appendices**

Appendix A1: Existing Water System Descriptions

Appendix A2: Surface Water Evaluation

Appendix A3: Collector Well Evaluation

Appendix A4: Hydraulic System Modeling

Appendix A5: Demand Reduction Scenarios

Appendix A6: Cost Estimating

Appendix A7: Water Quality Evaluation

Appendix A8: Enhanced Recharge Evaluation

Appendix A9: Stormwater Capture and Reuse Evaluation

Appendix A10: MCES Southeast Metro Sub-region Wastewater Reuse Concepts and Costs Memo

Appendix A11: Regional Implementation Planning Memo

## **Executive Summary**

The Metropolitan Council's (Council's) recognition of water supply planning as an integral component of long-term regional and local comprehensive planning has led to the implementation of a number of projects to provide necessary technical information to form the basis for sound water supply decisions. This study will inform the Council and the participating communities about the potential to diversify water sources to support a sustainable and reliable long-term regional water supply in the Southeast Metro Study Area of the Twin Cities Metropolitan Area.

### **Background**

Groundwater is the principal source for water supply for municipalities in the Metropolitan Area. The ratio of groundwater use to surface water use for municipal supply has increased over the last several decades and currently groundwater use measures approximately three times that of surface water use in the region (Metropolitan Council, 2015a). Groundwater modeling done by the Council projects that continued development of groundwater sources to meet future demands may have an adverse effect on resources, and conversely indicates benefit to the regional aquifers if demand on groundwater is reduced (Metropolitan Council, 2015b).

Managing water demands and having diversified water sources can support projected population growth and economic development in the region, and improve reliability and flexibility of water supply in the region. Enhancing groundwater sources through enhanced aquifer recharge or development of alternative sources, like the capture and beneficial use of stormwater for non-potable supply, could also improve the reliability of the region's water supply.

This report summarizes the analyses for Southeast Metro Study Area. It covers the northern portion of Dakota County, including the communities of Apple Valley, Burnsville, Eagan, Farmington, Inver Grove Heights, Lakeville, Mendota Heights, Rosemount, South St. Paul and West St. Paul.

The analyses in this study are a first look at diversifying water sources and enhancing bedrock aquifer recharge in this part of the Twin Cities Metropolitan Area. The scope of the assessments includes three main analysis components: Drinking Water Supply, Enhanced Recharge, and Stormwater Capture and Reuse. Examples of shared or cooperatively-developed water systems or districts are discussed in a separate assessment called Regional Implementation Planning. Similar analyses conducted for other sub-regions in the Metropolitan area are summarized in separate reports.

### **Drinking Water Supply**

The study includes the analysis of nine drinking water supply scenarios for the Southeast Metro Study area. Two of the scenarios assume the continued use of groundwater sources for two different demand conditions, and seven scenarios rely on the development of surface water sources in which water from either the Minnesota River or the Mississippi River could supply some or all of the projected year 2040 municipal water demands.

The development of each scenario included an estimate of capital and annual costs and an assessment of the potential affect on Prairie du Chien-Jordan aquifer levels associated with changing pumping conditions. All scenarios incorporate the cessation of groundwater pumping at the Kraemer Mining and Materials, Inc. (KMM) quarry by 2040.

The study includes two scenarios where it is assumed that groundwater supplies will be used to meet future 2040 demands. The first assumes the continued use of groundwater to meet municipal demands, but that a reduction of 20 percent can be achieved through conservation efforts. The second evaluates the continued development of groundwater sources for projected baseline 2040 demand conditions. Costs for the demand reduction scenario were estimated at \$131 million, while costs for the baseline scenario were estimated at \$152 million.

The other seven scenarios presented in this report offer a first look at the scale and costs for various sub-regional surface water systems that could address future supply challenges. Preliminary cost estimates for the surface water scenarios ranged from \$175 million for a 17 MGD surface water supply that would meet a portion of the study area's demands to nearly \$1.2 billion for a 135 MGD system that could meet the entire study area's demands with surface water. (It should be noted that the costs for surface water supply scenarios that meet only a portion of the study area's demands do not include costs for development of groundwater sources to meet the remaining demands.) These scenarios were not meant to be prescriptive, but generally represent potential configurations and scales for developing drinking water supplies to meet future demands in order to provide the Council a preliminary assessment of the feasibility and cost of a variety of options. Scenarios could be considered independently, or combined to evaluate different sources and configurations.

While these improvements are not without costs, they should be considered in the context of supply diversification. Other considerations should factor into the consideration of alternative supplies including the effect of projected water use on regional groundwater levels, system resiliency, source reliability, public acceptance and implementation challenges, and the degree to which any of the alternatives may have limited availability in the long-term.

### **Enhanced Recharge**

The feasibility study included an assessment of opportunities for enhanced groundwater recharge in Dakota County, including the entire Southeast Metro Study Area. Enhanced recharge is an integrated approach to water management that could provide benefit to regional aquifers. The analysis identified areas where water applied at the surface could infiltrate the subsurface efficiently, ultimately recharging permeable bedrock formations. Areas were classified into three categories using criteria that considered hydrogeologic conditions, land use, drinking water supply management areas, and other factors. Approximately 30,000 acres, or 21 percent of the study area, were classified as meeting feasibility criteria for enhanced recharge. Some of those sites lie in areas of heavy groundwater use where aquifer drawdown is projected to worsen over time.

### **Stormwater Capture and Reuse**

Stormwater capture and reuse refers to the large-scale diversion and collection of stormwater runoff for beneficial use. In this region of the country treated water is often used for urban irrigation, driving peak summertime demands. There is potential to reduce groundwater withdrawals and costs associated with peak water production through capture, retention and reuse of stormwater. This study's initial assessment identified significant opportunities that should be studied further to implement stormwater capture and reuse as an alternative supply to offset groundwater demands. In the study area, nearly 70 percent of the high-volume, non-potable use sites identified could potentially capture and reuse stormwater runoff as an alternative to either direct groundwater withdrawal, or municipal water use.

### **Wastewater Reuse**

Although the scope for this report did not include an analysis of reclaimed water as a potential water supply source, a preliminary study of wastewater reuse in a sub-region of the Southeast Metro Study Area conducted by Metropolitan Council Environmental Services is referenced. The study included an assessment of potential reclaimed water demands and costs for potential systems in the Empire Wastewater Treatment Plant service area.

### **Regional Implementation Planning**

Cooperative arrangements for water supply can and have been developed successfully in the region. Both Minneapolis and Saint Paul have demonstrated successful operation of wholesale and retail water service with neighboring communities. The recent development of a surface water system that serves Burnsville and Savage, and the Joint Powers Water Board that provides water for Albertville, Hanover and St. Michael are two systems that have demonstrated successful partnerships and the benefits of shared costs for treated water supply. Other examples from around the country offer the Twin Cities region templates for developing cooperative systems and fairly allocating costs across all users of a common regional resource. These models also demonstrate that the motivation to develop future supplies outside of continued development of groundwater sources will be limited, absent a driver in the form of regulatory source limitations or constraints.

### **Related Water Planning Efforts**

The Council is pursuing a number of studies and technical evaluations to support water supply planning and sustainability in the region with the intent of providing technical bases for communities to make informed water supply decisions. This study is one component of a larger effort that can ultimately lead to a regional roadmap to achieve sustainable and reliable water supply in an affordable and practical manner.

## Introduction

The Metropolitan Council (Council) contracted with HDR to study concepts related to drinking water supply in the Twin Cities Metropolitan Area. These studies consist of a set of analysis elements that can be applied to sub-regions, or study areas, within the larger Metropolitan Area. Although there may be some refinement in scope for a specific study area related to resource availability or constraint, the same general approach to the analyses can be applied to various regions.

This report summarizes the analyses for the Southeast Metro Study Area. It covers the northern portion of Dakota County, including the communities of Apple Valley, Burnsville, Eagan, Farmington, Inver Grove Heights, Lakeville, Mendota Heights, Rosemount, South St. Paul and West St. Paul<sup>1</sup>. The study area is shown in Figure 1.

The scope of the assessment includes three main analysis components: Drinking Water Supply, Enhanced Groundwater Recharge, and Stormwater Capture and Reuse<sup>2</sup>. Examples of shared or cooperatively-developed water systems or districts are discussed in a separate assessment called Regional Implementation Planning. Detailed results of the analyses for other sub-regions are summarized in separate documents.

## Background

Reliable sources of abundant and high quality water have been critical to development of the Twin Cities region. Population growth and expanding development are increasing demands on water supplies in the region (Metropolitan Council, 2015b). The metropolitan area is focusing greater attention on sustainable water supplies to meet these needs.

Groundwater modeling done by the Council shows that continued development of groundwater sources to meet future demands will have an adverse effect on resources, and conversely shows benefit to regional aquifers if demand on groundwater is reduced (Metropolitan Council, 2015b).

The Council is pursuing a number of studies and technical evaluations to provide guidance and technical bases for communities to make informed water supply decisions. This study is one component of a larger effort to create a regional roadmap focusing on sub-regional approaches for communities in the metropolitan region to achieve sustainable and reliable water supply in an affordable and practical manner.

The focus on the Southeast Metro Study Area resulted from the Council's work with sub-regional groundwater work groups. Several of these ad-hoc workgroups have been formed around the Metro area to address local water supply challenges and ensure sustainability of

---

<sup>1</sup> Mendota Heights and West St. Paul were excluded from the Drinking Water Supply portion of the analysis because they purchase water from Saint Paul Regional Water Services through long-term contracts. They were included in the Enhanced Recharge and Stormwater analyses.

<sup>2</sup> An analysis of the potential for treated wastewater reuse was included in the original scope for the project, but was removed pending the results of a similar study being conducted by the Wastewater division of Metropolitan Council Environmental Services.

water supplies. The Southeast Metro Area workgroup expressed interest in participating in the study to better understand projected water supply challenges, and explore potential alternatives. The results of the analyses can help the Council and the participating communities better understand the potential to diversify water sources in the region to support the long-term reliability and sustainability of water supply in the Twin Cities Metropolitan Area.

## **Drinking Water Supply**

The scope for the study includes identification and analysis of drinking water supplies for the Southeast Metro Study Area, including the continued development of groundwater sources, the potential effects of water conservation on groundwater source development, and the development of surface water supplies to meet future demands. A map of the study area is shown in Figure 1. The majority of the study area is served by groundwater, with the exception of Burnsville, which draws a portion of its water supply from a surface water source. Mendota Heights and West St. Paul, north of the study area, were excluded from the drinking water supply analysis because they are currently served by Saint Paul Regional Water Services through long-term water supply contracts.

The feasibility study included analysis of the development of surface water sources to serve the study area. Both the Minnesota River and the Mississippi River were analyzed for their capacity to serve municipal water demands through the year 2040. Scenarios were evaluated to consider future surface water supply options that would be able to meet peak demands, as well as scenarios where surface water would provide supply to meet average demands and peak demands would be met with groundwater supply in a conjunctive use system. The continued development of groundwater sources was also analyzed, including a scenario that incorporates a 20 percent demand reduction by each community by 2040 to reflect the potential effects of conservation efforts. Estimates of capital and annual costs, and figures showing the projected effect on Prairie du Chien-Jordan aquifer levels were generated for each scenario.

A review of the geology for siting potential horizontal collector wells (also referred to as Ranney™ wells, radial collector wells, and riverbank filtration wells) near the Minnesota River and the Mississippi River was also included in the analysis.

### **Demand Projections**

Average day and maximum day water demand projections through 2040 for the study area were developed for the analysis. The Council provided average day demand projections for 2040 that were developed as part of the regional Master Water Supply Plan Update, currently in progress. Average day demand projections were based on historical per capita water use factors for each community in the study area, and 2040 preliminary population forecasts from Thrive MSP 2040 (published September 11, 2013), which were modified in some cases with input from the individual cities.

Maximum day to average day peaking factors were obtained from the 2010 Master Water Supply Plan (Metropolitan Council, 2010) for each community in the study area. These peaking factors were then applied to average day projections to calculate maximum day demand projections for 2040.

The water demand projections are used in the evaluation of drinking water supply scenarios, including analysis of available surface water, and in sizing pumping, treatment and transmission infrastructure as part of the development of water supply scenarios.

Current (2010) and projected municipal water demands for the Southeast Metro Study Area are shown in Table 1. Peaking factors for the communities in the study area range from 1.8 to 3.1. The composite peaking factor for the study area is 2.7.

**Table 1. Southeast Metro Study Area Population and Water Demand Projections Summary**

City	2010 <sup>1</sup>			2040				
	Population	Average Day Demand (MGD)	Peak Day Demand (MGD) <sup>2</sup>	Population	Average Day Demand (MGD) <sup>3</sup>	Peak Day Demand (MGD)	Average Day Demand [-20%] <sup>4</sup> (MGD)	Peak Day Demand [-20%] <sup>4</sup> (MGD)
Apple Valley	50,000	8.4	21.0	65,400	7.8	19.6	6.3	15.7
Burnsville <sup>5</sup>	61,400	8.35	24.5	67,000	6.5	19.1	5.2	15.3
Eagan	70,500	10.11	26.8	74,270	10.3	27.3	8.2	21.8
Farmington	20,500	2.59	7.8	31,500	3.3	10.0	2.7	8.0
Inver Grove Heights	31,541	2.99	7.8	47,600	4.0	10.5	3.2	8.4
Lakeville	57,997	6.41	19.7	80,917	9.5	29.4	7.6	23.3
Rosemount	21,932	2.82	8.5	34,537	3.9	11.7	3.1	9.4
South St. Paul	19,900	2.80	5.5	22,482	3.6	6.5	2.9	5.2
Total Study Area	345,470	44.47	121.6	423,706	49.1	134.1	39.3	107.3

**Notes:**

- <sup>1</sup> The data for 2010 were taken from the 2010 Master Water Supply Plan, and from data provided by the cities in the study area.
- <sup>2</sup> Peaking factors were obtained from the 2010 Master Water Supply Plan: Apple Valley (2.5), Burnsville (2.93), Eagan (2.65), Farmington (3.0), Inver Grove Heights (2.6), Lakeville (3.08), Rosemount (3.0), South St. Paul (1.78).
- <sup>3</sup> 2040 average day demand projections are based on historical per capita water use factors for each community, and preliminary population forecasts from Thrive MSP 2040 (published September 11, 2013) modified with input from individual cities.
- <sup>4</sup> [-20%] Represents a water conservation scenario.
- <sup>5</sup> The projected 2040 water use for Burnsville represents groundwater use only. Existing surface water supply capacity, which fulfills a portion of current and future demands, is not included in the 2040 projections.

## Existing System Descriptions

Table 2 provides information on the individual water systems within the study area. Detailed descriptions of the systems, including plans for improvements and expansion, are included in Appendix A1.

**Table 2. Southeast Metro Study Area Water System Summary**

City	No. of Wells	Centralized Treatment	No. of Pressure Zones	Pipe Size Range	Total Storage Volume (MG)
Apple Valley	20	Yes	3	6" - 24"	14.7
Burnsville <sup>1</sup>	17	Yes	13	6" - 48"	18.6
Eagan	21	Yes	4	6" - 30"	18.5
Farmington	7	No	1	6" - 24"	2.27
Inver Grove Heights	7	Yes	4	6" - 30"	11.7
Lakeville	16	Yes	3	6" - 30"	8.85
Rosemount	8	No	2	6" - 16"	3.5
South St. Paul	7	No	3	6" - 12"	2.0

### Notes:

<sup>1</sup> The City of Burnsville has a surface water source and surface water treatment plant with a treatment capacity of 6 MGD (the capacity of the intake is currently less than the treatment plant capacity). Burnsville provides water on a wholesale basis to the City of Savage.

## Resource Evaluation

The analysis of water supplies for the study areas included a preliminary evaluation of potential surface water sources that could be developed to serve the study area. A preliminary assessment of the potential for collector wells installed near these major rivers to partially satisfy water demands in the study area was also performed.

### SURFACE WATER

The surface water evaluation included an analysis of potential supply from the Minnesota River, and the Mississippi River, which border the study area on the west, north, and east sides. Both river systems were analyzed for their capacity to serve the study area demands through the year 2040.

The assessment of surface water availability was based on the past climatic variability. Historical monthly river flow data were compiled and evaluated to gather information on previous drought duration and severity at two gaging stations: the Minnesota River near Fort Snelling State Park and the Mississippi River below the confluence with the Minnesota River near St. Paul, shown in Figure 2. This information was used to identify and focus on drought conditions that impacted stream flow in each system, and thus water availability. Where historical data were unavailable, flows were estimated using regional reference gages and statistical relationships. These historic measured or estimated low flows were adjusted based on minimum flow scenarios, providing a range of available surface water supply that may have been available based on historical hydrology. When compared to projected annual demand scenarios developed for the study area, the potential shortages of each supply source and frequency of shortages were determined.



Data and background information for the analysis is included in Appendix A2.

#### ANNUAL AND MONTHLY DEMAND EVALUATION

Municipal water demand amounts for current (Year 2010) and projected Year 2040 were provided by the Council. The annual demands were converted into average monthly demands for comparison with seasonal surface water availability. Monthly groundwater pumping data for the communities of Apple Valley, Burnsville, Farmington, and Rosemount was compiled for calendar years 2005 to 2013 to create a composite representation of typical demand patterns for the study area. The average monthly pumping was calculated over this timeframe and then expressed as a percentage of the annual total. Chart 1 shows the monthly distribution of demands. Winter months represent approximately 5% to 6% of the total annual demands for each month. The peak pumping month is July, where about 15% of the annual total is withdrawn. The 2010 monthly demand pattern was used to project monthly demand pattern in Year 2040.

**Chart 1. Monthly Distribution of Annual Demands**

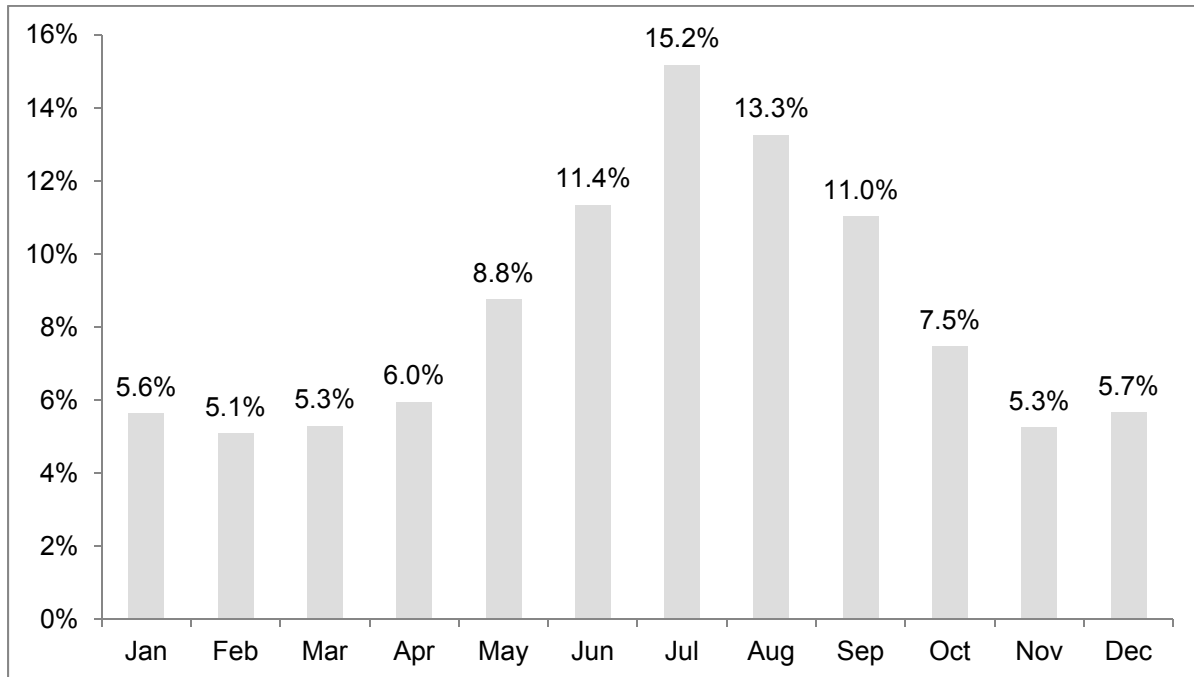


Table 3 provides the monthly and annual withdrawals for the current (Year 2010) and projected Year 2040 demands for the entire Southeast Metro Study Area. Winter demands in the current (Year 2010) scenario average about 920 million gallons (45 cfs) per month and peak to 2.5 billion gallons (123 cfs) per month in July. For the Year 2040 demand scenario, winter demands increase to about 0.9 to 1.0 billion gallons (50 cfs) per month in winter and peak at 2.7 billion gallons (136 cfs) in July.

**Table 3. Average Monthly and Total Annual Demands for the Southeast Metro Study Area**

<b>Time</b>	<b>Demand (Percent of Annual Total)</b>	<b>Year 2010 Demand (Million gallons)</b>	<b>Year 2040 Demand (Million gallons)</b>
January	5.6%	916 (46 cfs)	1,012 (51 cfs)
February	5.1%	826 (46 cfs)	913 (50 cfs)
March	5.3%	861 (43 cfs)	951 (47 cfs)
April	6.0%	967 (50 cfs)	1,068 (55 cfs)
May	8.8%	1,421 (71 cfs)	1,570 (78 cfs)
June	11.4%	1,844 (95 cfs)	2,036 (105 cfs)
July	15.2%	2,465 (123 cfs)	2,723 (136 cfs)
August	13.3%	2,153 (107 cfs)	2,378 (119 cfs)
September	11.0%	1,791 (92 cfs)	1,978 (102 cfs)
October	7.5%	1,214 (61 cfs)	1,341 (67 cfs)
November	5.3%	852 (44 cfs)	941 (49 cfs)
December	5.7%	920 (46 cfs)	1,016 (51 cfs)
Annual	100%	16,232 (44.8 MGD)	17,927 (49.1 MGD)

**Notes:**

Amounts may not sum to 100% due to rounding.

**MINNESOTA RIVER SURFACE WATER SUPPLY SHORTAGE ANALYSIS**

A water supply analysis of a surface water diversion on the Minnesota River was examined by taking the estimated monthly average historic flow data at the Minnesota River at Fort Snelling State Park gage site and comparing it to the projected 2040 total monthly average demand. The evaluation considered the potential for river sources to meet the total 2040 demand for the study area on an average monthly basis. Data show that the most critical year, in terms of flow availability, was 1934. The data also show that the most constrained monthly flow condition occurred in October 1921 (225 cfs).

Two minimum flow scenarios were considered. One assumed that the full river flow would be available for diversion. The other assumed  $Q_{90}$ <sup>3</sup> flow conditions, which would maintain a minimum amount of flow in the river prior to diversion. Under the full river flow scenario, there were no calculated shortages (defined as average monthly demands exceeding the monthly average river flow). Comparing monthly demands of 61 cfs (October 2010 estimate) and 67 cfs (October 2040 projection) to the minimum historic flow condition (225 cfs in October 2021), the remaining river flows would be 165 cfs and 158 cfs, respectively.

For the second scenario when the  $Q_{90}$  flow is used as the minimum, 52 years out of the 112 years in the historic period of record show at least one month when demands exceeded the available supply.

Table 4 and Table 5 show annual and maximum monthly shortages for select drought years while Chart 2 shows the annual shortages calculated over the period of record using the  $Q_{90}$  minimum flows and current and Year 2040 demand scenarios. The most critical drought year occurred in 1934. Under these flow conditions, it is estimated that an 85% annual shortage of the demands for the current (year 2010) conditions and an 85% annual shortage for the Year 2040 demand scenario would occur. The 1988 drought year shows about a 50% annual shortage for the two demand scenarios. Other representative years for other drought events have smaller annual shortages. In most cases, the month of the maximum shortage occurs in the summer.

**Table 4. Select Drought Shortage Statistics at Fort Snelling Gage (Current Year 2010 Demands, Q90 Minimum Flows)**

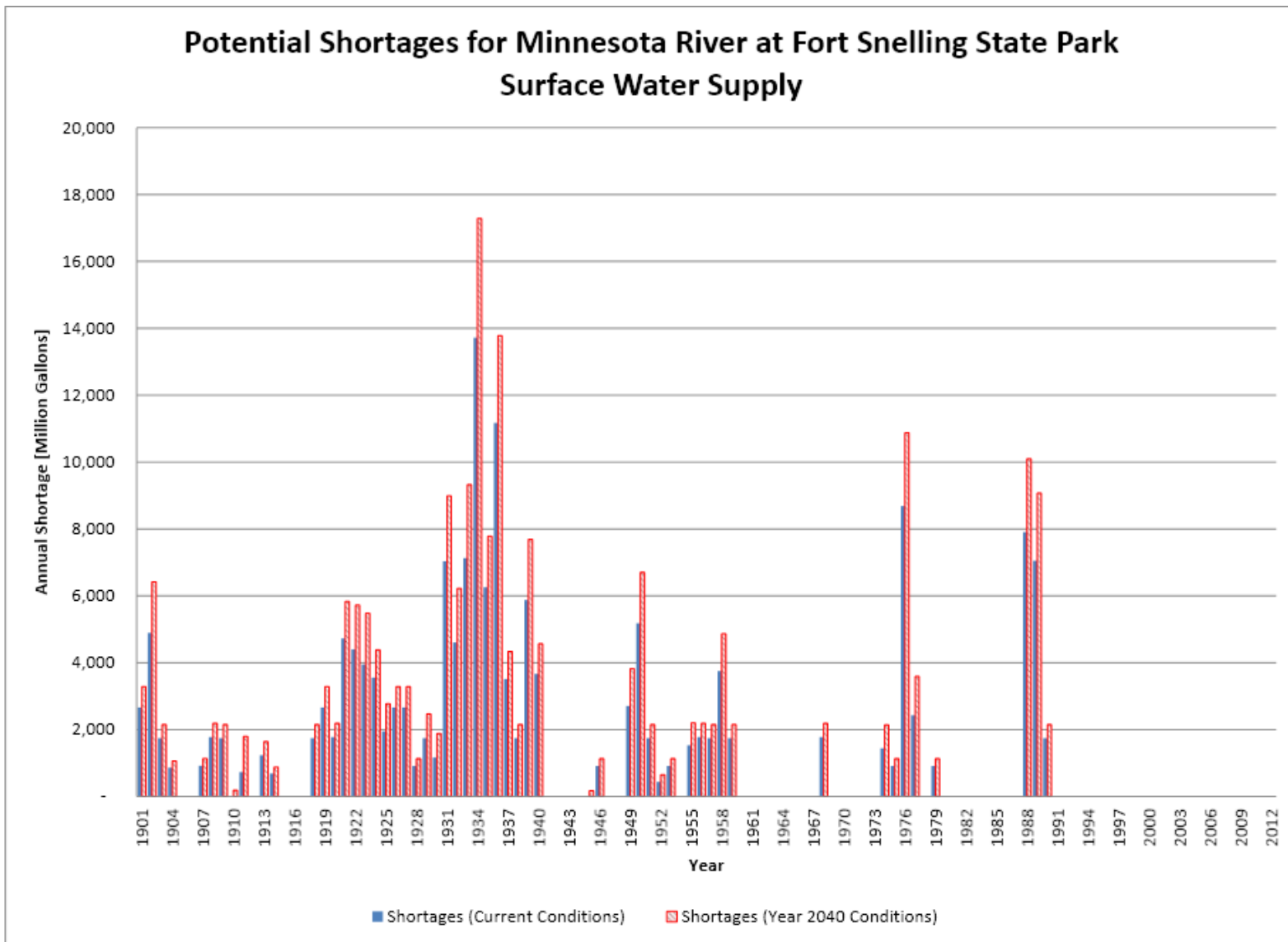
Select Drought Year	Annual Shortage [Million Gallons]	Maximum Monthly Shortage [Million Gallons]	Month of Maximum Shortage
1911	728	548	September
1923	3,948	1,254	September
1934	13,719	2,465	July
1959	1,743	916	January
1988	7,904	2,153	August

<sup>3</sup> Minnesota water law will limit or prevent consumptive water uses from surface water sources based on a set minimum in-stream flow. The minimum in-stream flow is intended to protect river and habitat uses including fisheries, riparian habitat, navigation, and recreation. The minimum flows may be determined from a detailed study, but most often are based on a statistic of flows passing a gage site 90% of the time (also known as  $Q_{90}$ ). By definition, the  $Q_{90}$  minimum flow target means at least 10% of the time there will be potential restrictions on water allocations.

**Table 5: Select Drought Shortage Statistics at Fort Snelling Gage (Year 2040 Demands, Q<sub>90</sub> Minimum Flows)**

Select Drought Year	Annual Shortage [Million Gallons]	Maximum Monthly Shortage [Million Gallons]	Month of Maximum Shortage
1911	1,173	735	September
1923	4,632	1,441	September
1934	15,314	2,723	July
1959	1,925	1,012	January
1988	8,885	2,378	August

Chart 2. Annual Shortages at Fort Snelling Gage (Current and Year 2040 Demands, Q<sub>90</sub> Minimum Flows)



**MISSISSIPPI RIVER SURFACE WATER SUPPLY ANALYSIS**

A water supply analysis for a potential representative surface water diversion on the Mississippi River downstream of the Minnesota River confluence was examined by taking the estimated monthly average historic flows at the Mississippi River at St. Paul gage site and comparing to the 2010 and 2040 monthly average demand scenarios. Two minimum flow scenarios were also incorporated by either assuming the full flow would be available for diversion or based on the Q<sub>90</sub> flow which would maintain a minimum amount of flow in the river prior to diversion. Under the minimum flow scenario assuming the full river flow would be available for diversion, there are no calculated shortages. The historic month with the most constrained supply is August 1934, with river flows of 864 cfs. After removing the demands of 107 cfs for the current (Year 2010) demand scenario or 119 cfs for the Year 2040 demand scenario the remaining river flows would be 756 cfs and 745 cfs, respectively.

When the Q<sub>90</sub> flow is used as the minimum flow scenario, 44 years out of the 112 years in the historic period of record show at least one month when demands exceed the available supply. Table 6 and Table 7 show annual and maximum monthly shortages for select drought years while Chart 3 shows the annual shortages calculated over the period of record. The critical drought year of 1934 has an 85% annual shortage of the demands for the current (year 2010) conditions and 85% annual shortage for the Year 2040 demand scenario. The 1988 drought year shows about a 50% annual shortage for the two demand scenarios. Other representative years for other drought events have smaller annual shortages. In most cases, the month of the maximum shortage occurs in summer.

**Table 6. Select Drought Shortage Statistics at St. Paul Gage (Current Demands, Q<sub>90</sub> Minimum Flows)**

Select Drought Year	Annual Shortage [Million Gallons]	Maximum Monthly Shortage [Million Gallons]	Month of Maximum Shortage
1911	2,663	920	January
1923	2,663	920	January
1934	13,843	2,465	July
1959	5,626	2,103	August
1988	8,253	2,465	July

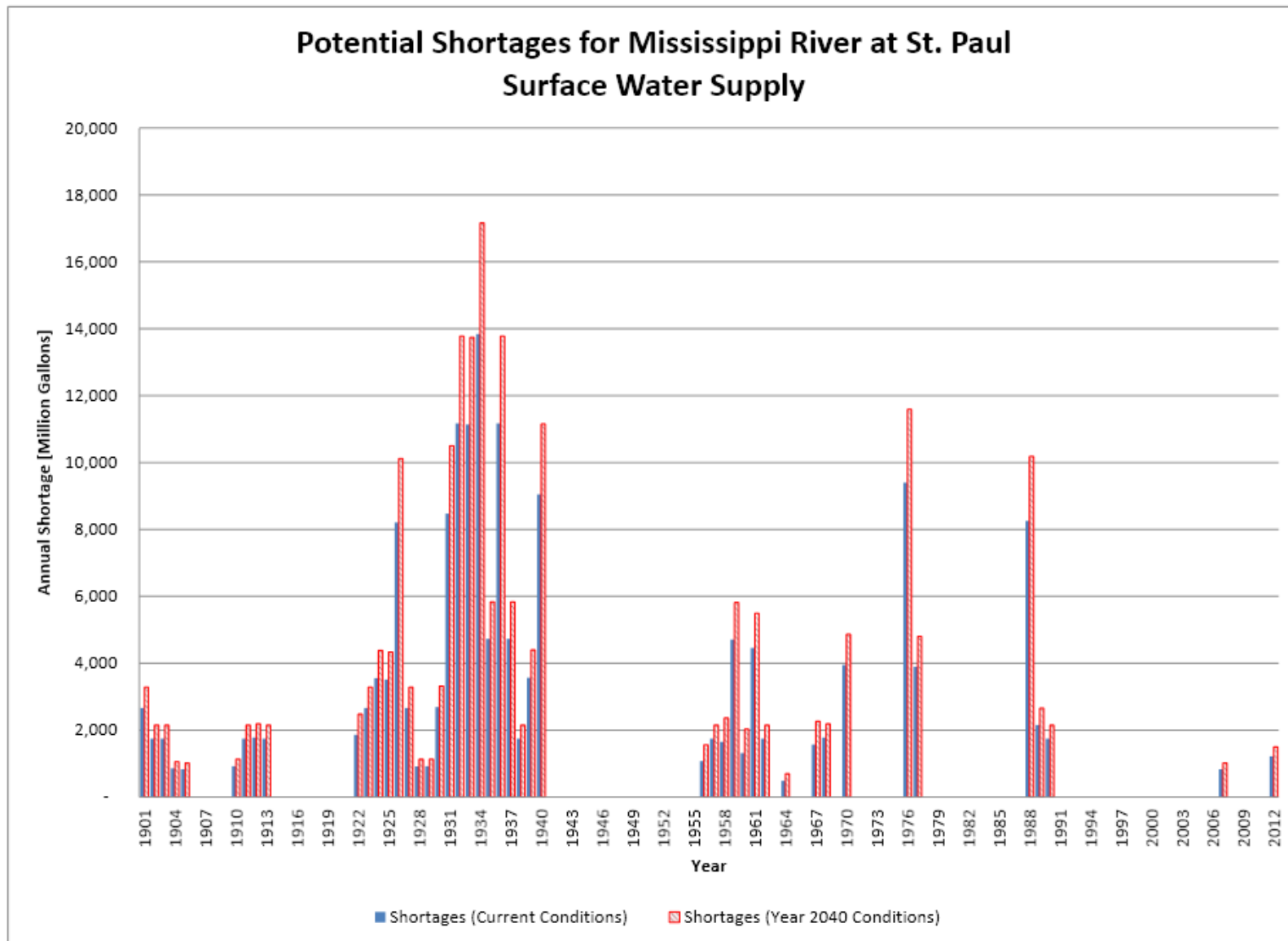
**Table 7. Select Drought Shortage Statistics at St. Paul Gage (Year 2040 Demands, Q<sub>90</sub> Minimum Flows)**

Select Drought Year	Annual Shortage [Million Gallons]	Maximum Monthly Shortage [Million Gallons]	Month of Maximum Shortage
1911	2,663	920	January
1923	2,663	920	January
1934	13,843	2,465	July
1959	5,626	2,103	August
1988	8,253	2,465	July

Supply from either the Minnesota River or Mississippi River downstream of the confluence of the Minnesota River appear to be viable options, and appear to have physically adequate supply for the projected year 2040 area demands on an annual basis, although low flow conditions during drought years could present supply challenges. Source availability accounting for daily fluctuations during peak demand periods should be further studied. The needs of competing and equal priority water uses along with minimum resource flows needed for water quality, navigation, and riparian habitat needs must also be considered. Maintaining secondary supplies for daily fluctuations in flow and to meet certain demands during critical drought years may also be important. In these situations, groundwater may serve as a supplemental source to a surface water supply in a conjunctive use system.

This study used past climatic variability to determine the potential for surface water supply. The analysis did not take into consideration daily fluctuations in river flows and demands, nor did it attempt to determine how past climate might translate into future river flows given population, agricultural, commercial, and industrial growth that has occurred in the past and is projected to occur in the future. If these options are pursued for development in the future, refinements to the analysis should include an examination of water uses in the larger watershed as well as incorporation of specifics on the location and nature of a potential water supply diversion. Establishing coordination with river stakeholders would be an advisable component in pursuing a surface water supply. These and other considerations are discussed in more detail in Appendix A2.

Chart 3. Annual Shortages at St. Paul Gage (Current and Year 2040 Demands, Q<sub>90</sub> Minimum Flows)





### **ALTERNATIVE SUPPLY - COLLECTOR WELLS**

A preliminary assessment of collector wells installed near the major rivers in the study areas was performed. For the Southeast Metro Study Area, areas along the Minnesota River and Mississippi River were reviewed for collector well suitability. The analysis assumed that the collector wells, if feasible, could be used as an alternative source to a direct surface water intake for a portion of total study area demands.

Collector wells, also called horizontal collector wells, function similarly to vertical wells but yield greater quantities of water. A collector well generally consists of a central, concrete caisson with horizontal well screens that project from the caisson into the aquifer. Water is drawn through the horizontal well screens and pumped from the central caisson. A schematic of a typical collector well is shown in Figure 3.

Collectors are designed to infiltrate water from the nearby surface water source and use the streambed and riverbank deposits to filter constituents such as microorganisms and suspended solids from the source water. Therefore, proximity to a surface water source that can recharge the aquifer, such as a major river, is a primary requirement for collector wells. Yield from a collector well will typically be derived from surface water and groundwater sources. Factors that influence the yield of a collector well include the permeability of the riverbed, the hydraulic conductivity of the aquifer, and the amount of available drawdown in the well (i.e., distance from static water level to top of well screens).

An analysis of existing geology data was performed to assess the potential development of collector wells in the study area. Areas along the Minnesota River on the western side of the study area, and along the Mississippi River along the northern and eastern sides of the study area were included in the analysis (see Figure 4). Background data and a detailed summary of the analysis are included in Appendix A3.

There are advantages and disadvantages to consider when comparing collector wells to vertical wells and surface water intakes. Collector well construction costs are much higher than vertical wells and in some cases can cost more than surface water intakes. Due to the ability to install long sections of well screen at the base of the most hydraulically efficient portion of the aquifer, collector well yields can be many times that of high capacity vertical wells. The yield of a collector is generally lower than a surface water intake.

Collector wells can provide a municipality with some degree of reliability during drought conditions compared to direct surface water intake systems since the well yield is drawn from below the surface and is derived from both groundwater and surface water sources. Water quality in collector wells depends on the quality of the groundwater and surface water sources. Collector wells benefit from natural filtration through the riverbank and aquifer which surface water intakes cannot achieve. Land acquisition and easement requirements for collectors can be less intensive than well fields and surface water intakes. A typical collector well might require one parcel of land for the caisson building and a limited number of easements for the transmission pipeline, assuming the collector well is in close proximity to the treatment plant. A field of vertical wells could require multiple parcels and pipeline easements.

Effects of collector well construction on natural resources can be minimal compared to a surface water intake since the well screens are drilled below the surface and trenching through potentially sensitive areas near rivers can usually be avoided. The environmental advantages of collector wells over surface water intakes could reduce permitting process time and expedite project implementation.

#### **MINNESOTA RIVER COLLECTOR WELLS**

Much of the study area adjacent to the Minnesota River is underlain by shallow bedrock or thick sequences of clayey till materials that are unsuitable for collector wells. However, a bedrock valley trends roughly east-west across Dakota and Hennepin counties and intersects the Minnesota River about one mile north of the Seneca Wastewater Treatment Plant in Eagan. This area was the focus of the evaluation of collector well potential along the Minnesota River. This area is shown in Figure 4.

The available boring logs in the vicinity of the bedrock valley near the Minnesota River indicate 45-90 feet of silty clay underlain by 40-135 feet of sand and gravel. The sand and gravel represents a potential target formation for horizontal collector well screens. The fine-grained material above the sand and gravel could potentially limit the rate of vertical recharge to the collector well from the Minnesota River. This could result in an increased ratio of groundwater-to-surface water withdrawal if collector wells were developed at this location, and the well yields would not be as high as in a situation with a more direct connection to the river. While the material on the boring logs does not represent the ideal situation for collector well yield, some thickness of fine material is preferable for riverbank filtration, and significant amounts of water could still be withdrawn from a properly designed and constructed well. Viability of a collector well at this location would need to be determined through site-specific test drilling and aquifer testing.

#### **MISSISSIPPI RIVER COLLECTOR WELLS**

Similar to the Minnesota River, the study area adjacent to the Mississippi River is underlain by mostly shallow bedrock or thick sequences of clayey till. However, there is a bedrock valley that trends roughly north-south under the Mississippi River on the east side of South St. Paul in Dakota County. The analysis focused on characterizing the sediments in this area, which is shown in Figure 4.

The available boring logs in the vicinity of the bedrock valley near the Mississippi River in South St. Paul indicate a narrow zone (approximately 600 feet, measured north to south) where appreciable thickness of sand and gravel material exists. The sand and gravel represents a potential target formation for horizontal collector wells. The clay lenses noted within the sand and gravel could potentially limit the rate of vertical recharge to the collector well from the Mississippi River. This might result in an increased ratio of groundwater-to-surface water withdrawal, and the well yield would not be as high as in a situation with a more direct connection to the river. While the material on the boring logs does not represent the ideal situation for collector well yield, some thickness of fine material is preferable for riverbank filtration, and significant amounts of water could still be withdrawn from a properly designed and constructed well. Viability of a collector well would need to be determined through site-specific test drilling and aquifer testing.

## **Drinking Water Supply Scenarios**

The analysis included the development of various water supply scenarios to meet projected 2040 water demands using both groundwater and surface water sources. Two of the scenarios assume the continued use of groundwater sources for two different demand conditions, a baseline demand scenario, and a conservation scenario in which demands would be reduced by 20 percent by 2040 as a result of conservation efforts. Seven other scenarios rely on the development of surface water sources in which water from either the Minnesota River or the Mississippi River could supply some or all of the projected year 2040 water demands. All scenarios incorporate the cessation of groundwater pumping at the Kraemer Mining and Materials, Inc. (KMM) quarry by 2040.

The groundwater scenarios included an assessment of capital and annual costs associated with infrastructure needed to meet 2040 demands under two demand conditions. These scenarios included:

- Continued development of groundwater sources under reduced demand conditions, where drinking water demands are reduced from the baseline projection by 20% in each community by 2040.
- Continued development of groundwater sources, where projected 2040 water demands are met by traditional groundwater supplies and capacity expansion;

A broad assessment of surface water supply alternatives using the Minnesota River or Mississippi River was performed to identify potential surface water scenarios that would meet 2040 demand projections for the study area. Scenarios were based on characteristics of the available water sources, projected average day and peak demand profiles, topography and compatibility of hydraulic grade between existing municipal distribution systems, and the physical configuration of those systems. Consideration was also given to areas that appear to be most susceptible to groundwater depletion in the future.

Technical review and hydraulic analyses of the existing water distribution systems in the study area were performed to evaluate the feasibility of delivering water from potential surface water sources through interconnected systems, and, alternatively, through dedicated transmission mains to service points within each community. Hydraulic models of the individual distribution systems in the study area were obtained, when available. Where data were unavailable, a skeletonized version of the pipe network for an individual community was developed using distribution system mapping. A single, combined model of the study area was developed using Bentley's WaterGEMS software. This model was used to evaluate supply strategies, and to develop infrastructure required for implementation of each of the scenarios. A description of the modeling used to evaluate water supply strategies, including a comparison of interconnected systems and dedicated transmission main system approaches is included in Appendix A4.

Using demand projections described previously and modeled capacities of the existing systems, a set of seven drinking supply scenarios was developed. Several of the scenarios were developed specifically to alleviate projected 2040 aquifer drawdown conditions as modeled using the Metro Model 3 regional groundwater model (Metropolitan Council, 2014).

The scenarios cover a range of supply conditions, including:

- Three alternatives for conjunctive use of groundwater and surface water, where average, or base, demands would be met with surface water supplies, and groundwater sources would be used to meet peak demands;
- Three alternatives to evaluate surface water supplies to meet total (peak) demands to a portion of the study area; and
- An ultimate demand scenario where surface water sources would meet total (peak) 2040 demands of the entire study area.

Most of the surface water scenarios assume that treated surface water would be provided to communities in the study area using dedicated transmission pipelines, rather than interconnection through the existing networks. In these scenarios, treated surface water would be delivered to a central distribution point within each community, represented by either an existing or planned location for a water treatment plant. The analysis described in Appendix A4 showed that system interconnection (as opposed to dedicated transmission mains) would only be viable between South St. Paul and Inver Grove Heights for the scale of delivery evaluated in this study. This is due to the hydraulic and physical configuration of the existing water systems. As a result, in the scenarios that provide treated surface water to South St. Paul, it was assumed that service would be provided via interconnection with Inver Grove Heights.

The scenarios that were developed are not meant to be prescriptive, but represent potential configurations and scales for developing alternative drinking water supplies, and for understanding the feasibility and cost of a variety of options. Scenarios can be considered independently, or bundled together to evaluate different sources and configurations.

Water supply scenarios are summarized in Table 8. Detailed descriptions of each scenario and a table listing transmission main diameter, length, and flow by pipe segment are included in the following subsections. A description of each of the pipe segments common to all scenarios is included in the hydraulic analysis discussion in Appendix A4. The effects of the each scenario's modified pumping conditions on aquifer levels were estimated by Met Council using the Metro Model 3 regional groundwater model (Metropolitan Council, 2014). Figures showing the system layouts and the model-projected drawdown and recovery are also provided for each scenario.

**Table 8. Drinking Water Supply Scenarios**

Scenario	Description
Groundwater Scenario 1 Continued Development of Groundwater Sources with 20% Demand Reduction through Conservation	All 8 communities would reduce water consumption by 20% by 2040. Average and peak demands would be met by groundwater sources. Pumping at KMM quarry ceases.
Groundwater Scenario 2 Continued Development of Groundwater Sources	Groundwater sources and water treatment capacity expansion would meet total 2040 demands for all 8 communities. Pumping at KMM quarry ceases.
Surface Water Scenario 1	42 MGD Minnesota River supply capable of providing 2040 average day demands to Apple Valley, Burnsville, Eagan, Farmington, Lakeville and Rosemount. Additional (peak) demands in the study area would be met by groundwater sources. Groundwater sources would meet total 2040 demands for South St Paul and Inver Grove Heights. Pumping at KMM quarry ceases.
Surface Water Scenario 2	50 MGD Minnesota River supply capable of providing 2040 average day demands to all 8 communities in the Southeast Metro Study Area. Additional (peak) demands would be met by groundwater sources. Pumping at KMM quarry ceases.
Surface Water Scenario 3	40 MGD Minnesota River supply capable of providing total 2040 demands to Apple Valley, Rosemount, and the south zone in Eagan. Other demands in the study area would be met by groundwater sources. Pumping at KMM quarry ceases.
Surface Water Scenario 4	60 MGD Minnesota River supply capable of providing total 2040 peak demands to Apple Valley, Eagan and Rosemount. Other demands in the study area would be met by groundwater sources. Pumping at KMM quarry ceases.
Surface Water Scenario 5	17 MGD Mississippi River supply capable of providing total 2040 peak demands to South St. Paul and Inver Grove Heights. Other demands in the study area would be met by groundwater sources. Pumping at KMM quarry ceases.
Surface Water Scenario 6	50 MGD Mississippi River supply capable of providing 2040 average day demands for all 8 communities in the study area. Additional (peak) demands would be met by groundwater sources. Pumping at KMM quarry ceases.
Surface Water Scenario 7	135 MGD Mississippi River supply capable of providing total 2040 demands for all 8 communities in the study area. Pumping at KMM quarry ceases.

**GROUNDWATER SCENARIO 1: CONTINUED DEVELOPMENT OF GROUNDWATER SOURCES, 20% REDUCTION IN DEMAND BY 2040**

For the conservation, or demand reduction scenario, projected municipal drinking water demands were reduced by 20 percent by 2040. These reduced demands were compared with current system capacities to determine the future capacity that would be needed to meet drinking water demands. In the reduced demand scenario a total of three new wells would be needed to meet total projected 2040 demands.

This scenario assumes that municipal demands are reduced by 2040, but that groundwater pumping would continue at the Flint Hills Resources refinery.

Where communities are planning for the addition of centralized treatment facilities to remove iron and manganese from the groundwater supply, these assumptions were included in the reduced demand scenario.

Infrastructure needs to meet projected 2040 demands using groundwater under a reduced demand scenario are shown in Table 9. Figure 5 shows the effect of this scenario on regional aquifer levels modeled using Metro Model 3.

**Table 9. Continued Development of Groundwater Sources Scenarios**

City	Current Firm Production Capacity <sup>1</sup> (MGD)	Projected 2040 Peak Day Demand [-20%] <sup>3</sup> (MGD)	Number of New Wells Needed <sup>2</sup>	Projected 2040 Peak Day Demand (MGD)	Number of New Wells Needed <sup>2</sup>	Estimated Water Treatment Capacity Addition (MGD) <sup>4</sup>
Apple Valley	34.2	15.7	0	19.6	0	0
Burnsville <sup>5</sup>	30.5	15.3	0	19.1	0	0
Eagan	28.6	21.8	0	27.3	0	0
Farmington	10.4	8.0	0	10.0	0	12
Inver Grove Heights	10.1	8.4	0	10.5	1	0
Lakeville	20.5	23.3	2	29.4	6	10
Rosemount	8.6	9.4	1	11.7	2	10.4
South St. Paul	11.5	5.2	0	6.5	0	0
Total Study Area	154.5	107.3	3	134.1	9	32.4

**Notes:**

- <sup>1</sup> Firm production capacity is defined as the pumping capacity with the largest well out of service.
- <sup>2</sup> Assumes 1,200 gpm wells.
- <sup>3</sup> [-20%] represents a water conservation scenario.
- <sup>4</sup> Includes new and expanded iron and manganese filtration facilities.
- <sup>5</sup> The projected 2040 water use for Burnsville represents groundwater use only. Existing surface water supply capacity, which fulfills a portion of current and future demands, is not included in the 2040 projections.

For comparison, additional demand reduction scenarios were analyzed for effects on aquifer drawdown and recovery (no costs or system descriptions were developed for these scenarios):

- 15% decrease in 2040 municipal drinking water demands in the study area;
- 20% decrease in 2040 municipal drinking water demands, and all groundwater pumping eliminated at the Flint Hills Resources refinery; and
- 25% decrease in 2040 municipal drinking water demands in the study area.

Appendix A5 contains figures showing the effect of each of these additional demand reduction scenarios on regional aquifer levels using Metro Model 3.

## **GROUNDWATER SCENARIO 2: CONTINUED DEVELOPMENT OF GROUNDWATER SOURCES**

Projected peak demands were compared with current system capacities to determine an estimated number of new wells and associated infrastructure that would be needed to meet projected demands in the baseline 2040 demand scenario. A total of nine new wells would be needed to meet total projected demands in this scenario. This scenario assumes that groundwater pumping would continue at the Flint Hills Resources refinery.

Several of the communities in the study area are planning for the addition of centralized treatment facilities to remove iron and manganese from the groundwater supply. In these cases, the costs for treatment facilities were included in the scenario development.

Infrastructure needs to meet projected 2040 demands under this are shown in Table 9. Figure 6 shows the effect of this scenario on regional aquifer levels modeled using Metro Model 3.

## **SURFACE WATER SCENARIO 1: 42 MGD MINNESOTA RIVER SUPPLY**

In this scenario the communities closest to the Minnesota River would be supplied by a 42 MGD treatment plant located along the Minnesota River. The scenario assumes that Apple Valley, Burnsville, Eagan, Farmington, Lakeville and Rosemount will be supplied with their projected 2040 average day demands with surface water and demands above average day demand capacity would be supplied by existing groundwater sources in a conjunctive use system. South St. Paul and Inver Grove Heights would remain on groundwater sources.

The scenario includes the pipe segments listed in Table 10 below and assumes there would be two high service pumps stations at the Minnesota River Surface Water treatment plant to serve the communities. The first would be a 230 hp pump station used to supply the north zone of Eagan and the second will be a 2,840 hp pump station to supply the rest of the communities. Table 10 shows the general location of facilities and the conceptual alignment used for the analysis for the transmission system. Figure 8 shows the effect of this scenario on regional aquifer levels using Metro Model 3.

**Table 10. Surface Water Scenario 1 Pipe Segments**

<b>Segment #</b>	<b>Flow (MGD)</b>	<b>Length (miles)</b>	<b>Pipe Size (in)</b>
Minn - 1	6.9	2.3	20
Minn - 3	34.6	2.7	48
Minn - 4	6.5	3.5	20
Minn - 5	3.4	2.5	18
Minn - 6	24.6	3.0	42
Minn - 7	11.7	1.1	30
Minn - 8	3.9	4.2	18
Minn - 9	12.9	4.5	30
Minn - 10	9.5	2.0	24
Minn - 11	3.3	3.3	18

### **SURFACE WATER SCENARIO 2: 50 MGD MINNESOTA RIVER SUPPLY**

Surface Water Scenario 2 assumes that 2040 average day demands for all eight communities in the study area would be served by a 50 MGD treatment plant located along the Minnesota River. Demands above average day demand capacity would be supplied by existing groundwater sources in a conjunctive use system.

The scenario includes the pipe segments listed in Table 11 below, and two high service pump stations at the Minnesota River surface water treatment plant to serve the communities. The first would be a 1,000 hp pump station used to supply Eagan’s north zone along with Inver Grove Heights and South St. Paul, and the second would be a 3,070 hp pump station to supply the rest of the communities. Figure 9 shows the general location of facilities and the conceptual alignment used for the analysis for the transmission system. Figure 10 shows the effect of this scenario on regional aquifer levels using Metro Model 3.

**Table 11. Surface Water Scenario 2 Pipe Segments**

<b>Segment #</b>	<b>Flow (MGD)</b>	<b>Length (miles)</b>	<b>Pipe Size (in)</b>
Minn - 1	14.5	2.3	30
Minn - 2	7.7	6.9	24
Minn - 3	34.6	2.7	48
Minn - 4	6.5	3.5	20
Minn - 5	3.4	2.5	18
Minn - 6	24.6	3.0	42
Minn - 7	11.7	1.1	30
Minn - 8	3.9	4.2	18
Minn - 9	12.9	4.5	30
Minn - 10	9.5	2.0	24
Minn - 11	3.3	3.3	18

### **SURFACE WATER SCENARIO 3: 40 MGD MINNESOTA RIVER SUPPLY**

Surface Water Scenario 3 assumes that total 2040 demands for Apple Valley, Rosemount and the area of Eagan supplied by the southern Eagan treatment plant would be served by a 40 MGD surface water treatment plant located along the Minnesota River. Other demands in the study area would be met by groundwater sources.

The scenario includes pipe segments listed in Table 12 below, and a single 3,590 hp high service pump station to pump water to the communities. Figure 11 shows the general location of facilities and conceptual alignment used for the analysis for the transmission system. Figure 12 shows the effect of this scenario on regional aquifer levels using Metro Model 3.



**Table 12. Surface Water Scenario 3 Pipe Segments**

<b>Segment #</b>	<b>Flow (MGD)</b>	<b>Length (miles)</b>	<b>Pipe Size (in)</b>
Minn - 3	40.4	2.7	42
Minn - 5	9.1	2.5	18
Minn - 6	31.3	3.0	36
Minn - 7	31.3	1.1	36
Minn - 8	11.7	4.2	24

**SURFACE WATER SCENARIO 4: 60 MGD MINNESOTA RIVER SUPPLY**

Surface Water Scenario 4 assumes that total projected 2040 demands for Apple Valley, Rosemount and all of Eagan would be served by a 60 MGD treatment plant located along the Minnesota River. Other demands in the study area would be met by groundwater sources.

The scenario includes the pipe segments listed in Table 13 below, and also includes two high service pumps stations at the treatment plant to serve the communities. The first would be a 760 hp pump station used to deliver water to Eagan’s northern treatment plant location and the second would be a 3,560 hp pump station to supply the rest of the communities. Figure 13 shows the general location of facilities and conceptual alignment used for the analysis for the transmission system. Figure 14 shows the effect of this scenario on regional aquifer levels using Metro Model 3.

**Table 13. Surface Water Scenario 4 Pipe Segments**

<b>Segment #</b>	<b>Flow (MGD)</b>	<b>Length (miles)</b>	<b>Pipe Size (in)</b>
Minn - 1	18.2	2.3	30
Minn - 3	40.4	2.7	42
Minn - 5	9.1	2.5	18
Minn - 6	31.3	3.0	36
Minn - 7	31.3	1.1	36
Minn - 8	11.7	4.2	24

**SURFACE WATER SCENARIO 5: 17 MGD MISSISSIPPI RIVER SUPPLY**

Surface Water Scenario 5 assumes that total projected 2040 demands for Inver Grove Heights and South St. Paul would be served by a 17 MGD surface water treatment plant on the Mississippi River. This scenario assumes that water would be delivered from the Mississippi River treatment plant to the Inver Grove Heights Water Treatment Plant. South St. Paul would be supplied by Inver Grove Heights through an interconnected system, as this was shown to be feasible in a hydraulic evaluation of the distribution systems (Appendix A4). Other demands in the study area would be met by groundwater sources.

The scenario includes the pipe segments listed in Table 14 below, and also assumes a 1,140 hp high service pump station to pump water to the communities.

Figure 15 shows the general location of facilities and conceptual alignment of the transmission system. Figure 16 shows the effect of this scenario on regional aquifer levels using Metro Model 3.

**Table 14. Surface Water Scenario 5 Pipe Segments**

<b>Segment #</b>	<b>Flow (MGD)</b>	<b>Length (miles)</b>	<b>Pipe Size (in)</b>
Miss - 1	17.0	2.9	30
Miss - 2	17.0	2.6	30

**SURFACE WATER SCENARIO 6: 50 MGD MISSISSIPPI RIVER SUPPLY**

Surface Water Scenario 6 assumes that all of the communities in the study area would be served by a 50 MGD treatment plant located along the Mississippi River. In this scenario, water would be provided to meet projected 2040 average day demands for the entire study area. Demands above average day demand capacity would be supplied by existing groundwater sources in a conjunctive use system.

The scenario includes the pipe segments listed in Table 15 below, and assumes a 5,010 hp high service pump station to pump water to the communities. Figure 17 shows the general location of facilities and conceptual alignment used for the analysis for the transmission system. Figure 18 shows the effect of this scenario on regional aquifer levels using Metro Model 3.

**Table 15. Surface Water Scenario 6 Pipe Segments**

<b>Segment #</b>	<b>Flow (MGD)</b>	<b>Length (miles)</b>	<b>Pipe Size (in)</b>
Miss - 1	49.1	2.9	54
Miss - 2	7.7	2.6	24
Miss - 3	41.4	7.8	54
Miss - 4	16.8	2.8	36
Miss - 5	6.9	3.9	20
Miss - 6	6.5	6.0	20
Miss - 7	24.6	3.0	42
Miss - 8	3.9	0.7	18
Miss - 9	20.7	2.7	36
Miss - 10	7.8	1.1	24
Miss - 11	12.9	2.0	30
Miss - 12	9.5	4.8	24
Miss - 13	3.3	3.5	18

**SURFACE WATER SCENARIO 7: 135 MGD MISSISSIPPI RIVER SUPPLY**

This scenario assumes a 135 MGD treatment plant along the Mississippi River, to meet total projected 2040 demands for all of the communities in the study area. This would essentially eliminate groundwater use for municipal supply in the study area.

The scenario includes the pipe segments listed in Table 16 below, and also assumes a 16,390 hp high service pump station would be required to pump water to the communities. Figure 19 shows the general location of the facilities, and the conceptual alignment used for the analysis of the transmission system. Figure 20 shows the effect of this scenario on regional aquifer levels using Metro Model 3.

**Table 16. Surface Water Scenario 7 Pipe Segments**

<b>Segment #</b>	<b>Flow (MGD)</b>	<b>Length (miles)</b>	<b>Pipe Size (in)</b>
Miss - 1	134.1	2.9	72
Miss - 2	17.0	2.6	30
Miss - 3	117.1	7.8	66
Miss - 4	46.4	2.8	42
Miss - 5	18.2	3.9	30
Miss - 6	19.1	6.0	30
Miss - 7	70.7	3.0	54
Miss - 8	11.7	0.7	24
Miss - 9	59.0	2.7	48
Miss - 10	19.6	1.1	30
Miss - 11	39.4	2.0	42
Miss - 12	29.4	4.8	36
Miss - 13	10.0	3.5	20

### **Costs**

Preliminary costs for each drinking water supply scenario were developed. Costs include capital costs for intake, treatment, pumping, storage and transmission mains, other project costs including engineering, environmental studies and land costs, and annual operations and maintenance costs. Costs for the surface water scenarios do not include costs associated with development of groundwater sources where surface water is provided for a portion of the demands in the study area. Additional costs associated with these scenarios would include wells, groundwater treatment, or other infrastructure and would increase the costs of these scenarios. Cost estimates for each water supply scenario are presented in Table 17 through Table 25 in this section.

Construction costs cover the material, equipment, labor and services necessary to build the infrastructure included in each water supply scenario. Prices used in this study were obtained from a review of water supply cost estimates, Council correspondence, and other sources of construction cost information. Construction costs used in this report are not intended to represent the lowest prices which may be achieved but rather are intended to represent a median of competitive prices submitted by responsible bidders.

Other project costs include design contingencies, engineering, administrative and legal costs, environmental and cultural resource studies, and land acquisition and surveying services associated with project design and construction.

Design contingencies can add to planning level estimates of project cost. To cover these costs an allowance of thirty percent<sup>4</sup> (30%) of the construction costs is included in the total project costs. Contingencies include such factors as unexpected construction conditions, the need for unforeseen mechanical and electrical equipment, and variations in final quantities. Total project costs also include a twenty percent (20%) allowance for engineering services, legal, and administrative costs. The engineering, legal, and administrative costs are added to the construction plus construction contingency values. Land acquisition, survey, environmental and archaeology studies and mitigation activities are added on top of the contingencies and engineering, legal and administrative costs.

The cost estimates prepared in this report are estimated in 2013-14 dollars. Further information on assumptions and unit prices used in the cost estimates are summarized in Appendix A6.

Final cost estimates will vary from the planning level cost estimates depending on actual labor and material costs, competitive market conditions, final project scope, implementation schedule and other variable factors that are difficult to forecast. Project feasibility and funding needs should be carefully reviewed prior to making specific financial decisions regarding any capital improvement project.

---

<sup>4</sup> Based on recommendation from the Council in draft report comments.

**Table 17. Groundwater Scenario 1 Costs**

<b>Cost Estimate Summary</b>	
<b>Groundwater Scenario 1. Continued development of groundwater sources to meet total projected 2040 demands for Apple Valley, Burnsville, Eagan, Farmington, Inver Grove Heights, Lakeville, Rosemount and South St. Paul.</b>	
<b>Item</b>	<b>Estimated Costs for Facilities</b>
<b>CAPITAL COSTS</b>	
Transmission Pump Station(s) (32.4 MGD)	\$3,694,000
Well Fields (9 Wells, Pumps, and Piping)	\$15,267,000
Water Treatment Plant (32.4 MGD)	\$58,380,000
Miscellaneous (Integration, etc.)	\$621,000
<b>TOTAL COST OF FACILITIES</b>	<b>\$77,962,000</b>
<b>PROJECT COSTS</b>	
Design Contingencies (30%)	\$23,389,000
Engineering, Administration and Legal (20%)	\$20,270,000
Environmental & Archaeology Studies and Mitigation	\$14,645,000
Land Acquisition and Surveying (30 acres)	\$3,914,000
Interest During Construction (4% for 4 years with a 4% ROI)	\$11,215,000
<b>TOTAL COST OF PROJECT</b>	<b>\$151,395,000</b>
<b>OPERATION AND MAINTENANCE COSTS</b>	
Pump Stations and Storage Tanks (3% of Cost of Facilities)	\$111,000
Water Treatment Plant (12% of Cost of Facilities)	\$7,006,000
Well Fields (3% of Cost of Facilities)	\$458,000
Pumping Energy Costs (5.8M kW-hr @ 0.072 \$/kW-hr)	\$390,000
Treatment Energy Costs (1.4M kW-hr @ 0.067 \$/kW-hr)	\$96,000
Purchase of Water (5,702 MG/yr @ 8.00 \$/MG)	\$46,000
<b>TOTAL ANNUAL O&amp;M COST</b>	<b>\$8,107,000</b>
<b>DEBT SERVICE COSTS</b>	
Pump Stations including Intake Debt Service	\$751,000
Water Treatment Plant Debt Service	\$7,640,000
Wells and Pipelines Debt Service	\$1,730,000
Miscellaneous Debt Service	\$71,000
<b>TOTAL ANNUAL DEBT SERVICE COST</b>	<b>\$10,192,000</b>
<b>TOTAL ANNUAL COST</b>	<b>\$18,299,000</b>

**Table 18. Groundwater Scenario 2 Costs**

<b>Cost Estimate Summary</b>	
<b>Groundwater Scenario 2. Conservation Scenario. Continued development of groundwater sources to meet total projected 2040 demands under a reduced demand scenario for Apple Valley, Burnsville, Eagan, Farmington, Inver Grove Heights, Lakeville, Rosemount and South St. Paul. Demands are projected to be reduced by 20% by 2040.</b>	
<b>Item</b>	<b>Estimated Costs for Facilities</b>
<b>CAPITAL COSTS</b>	
Transmission Pump Station(s) (32.4 MGD)	\$3,694,000
Well Fields (3 Wells, Pumps, and Piping)	\$5,089,000
Water Treatment Plant (32.4 MGD)	\$58,380,000
Miscellaneous (Integration, etc.)	\$621,000
<b>TOTAL COST OF FACILITIES</b>	<b>\$67,784,000</b>
<b>PROJECT COSTS</b>	
Design Contingencies (30%)	\$20,335,000
Engineering, Administration and Legal (20%)	\$17,624,000
Environmental & Archaeology Studies and Mitigation	\$3,326,000
Land Acquisition and Surveying (25.5 acres)	\$12,293,000
Interest During Construction (4% for 4 years with a 4% ROI)	<u>\$9,709,000</u>
<b>TOTAL COST OF PROJECT</b>	<b>\$131,071,000</b>
<b>OPERATION AND MAINTENANCE COSTS</b>	
Pump Stations and Storage Tanks (3% of Cost of Facilities)	\$111,000
Water Treatment Plant (12% of Cost of Facilities)	\$7,006,000
Well Fields (3% of Cost of Facilities)	\$153,000
Pumping Energy Costs (2.8M kW-hr @ 0.072 \$/kW-hr)	\$174,000
Treatment Energy Costs (1.4M kW-hr @ 0.067 \$/kW-hr)	\$96,000
Purchase of Water (1,898 MG/yr @ 8.00 \$/MG)	<u>\$15,000</u>
<b>TOTAL ANNUAL O&amp;M COST</b>	<b>\$7,555,000</b>
<b>DEBT SERVICE COSTS</b>	
Pump Stations including Intake Debt Service	\$750,000
Water Treatment Plant Debt Service	\$7,528,000
Wells and Pipelines Debt Service	\$519,000
Miscellaneous Debt Service	<u>\$71,000</u>
<b>TOTAL ANNUAL DEBT SERVICE COST</b>	<b>\$8,868,000</b>
<b>TOTAL ANNUAL COST</b>	<b>\$16,423,000</b>

**Table 19. Surface Water Scenario 1 Costs**

<b>Cost Estimate Summary</b>	
<b>Surface Water Scenario 1, 42 MGD Minnesota River WTP, Provides 2040 Average Day Capacity to Apple Valley, Burnsville, Eagan, Farmington, Lakeville and Rosemount</b>	
<b>Item</b>	<b>Estimated Costs for Facilities</b>
<b>CAPITAL COSTS</b>	
Intake and Pump Station (42 MGD)	\$5,389,000
Transmission Pipeline (30 miles)	\$53,016,000
Transmission Pump Station(s) (42 MGD)	\$16,022,000
Storage Tanks and Control-Meter Vaults (5.5 MG)	\$8,702,000
Water Treatment Plant (42 MGD) and Intake and Clearwell Storage (92 MG)	\$127,489,000
Miscellaneous (Integration, etc.)	<u>\$2,106,000</u>
<b>TOTAL COST OF FACILITIES</b>	<b>\$212,724,000</b>
<b>PROJECT COSTS</b>	
Design Contingencies (30%)	\$63,817,000
Engineering, Administration and Legal (20%)	\$55,308,000
Environmental & Archaeology Studies and Mitigation	\$6,435,000
Land Acquisition and Surveying (45 acres)	\$61,030,000
Interest During Construction (4% for 4 years with a 4% ROI)	<u>\$31,946,000</u>
<b>TOTAL COST OF PROJECT</b>	<b>\$431,260,000</b>
<b>OPERATION AND MAINTENANCE COSTS</b>	
Pipelines (1% of Cost of Facilities)	\$530,000
Pump Stations and Storage Tanks (3% of Cost of Facilities)	\$1,099,000
Water Treatment Plant (12% of Cost of Facilities)	\$14,769,000
Pumping Energy Costs (14.5M kW-hr @ 0.072 \$/kW-hr)	\$1,043,000
Treatment Energy Costs (4.2M kW-hr @ 0.067 \$/kW-hr)	\$281,000
Purchase of Water (15,330 MG/yr @ 8.00 \$/MG)	<u>\$122,000</u>
<b>TOTAL ANNUAL O&amp;M COST</b>	<b>\$17,844,000</b>
<b>DEBT SERVICE COSTS</b>	
Pipelines Debt Service	\$9,635,000
Pump Stations including Intake Debt Service	\$3,174,000
Storage Tanks Debt Service	\$1,635,000
Water Treatment Plant including Intake and Clearwell Storage Debt Service	\$17,026,000
Miscellaneous Debt Service	\$263,000
<b>TOTAL ANNUAL DEBT SERVICE COST</b>	<b>\$31,733,000</b>
<b>TOTAL ANNUAL COST</b>	<b>\$49,577,000</b>

**Table 20. Surface Water Scenario 2 Costs**

<b>Cost Estimate Summary</b>	
<b>Surface Water Scenario 2, 50 MGD Minnesota River WTP, Provides 2040 Average Day Capacity to Apple Valley, Burnsville, Eagan, Farmington, Inver Grove Heights, Lakeville and Rosemount, South St. Paul</b>	
<b>Item</b>	<b>Estimated Costs for Facilities</b>
<b>CAPITAL COSTS</b>	
Intake and Pump Station (50 MGD)	\$7,753,000
Transmission Pipeline (36 miles)	\$66,383,000
Transmission Pump Station(s) (50 MGD)	\$20,080,000
Storage Tanks and Control-Meter Vaults (6.5 MG)	\$10,482,000
Water Treatment Plant (50 MGD) and Intake and Clearwell Storage (104 MG)	\$149,661,000
Miscellaneous (Integration, etc.)	<u>\$2,544,000</u>
<b>TOTAL COST OF FACILITIES</b>	<b>\$256,903,000</b>
<b>PROJECT COSTS</b>	
Design Contingencies (30%)	\$77,071,000
Engineering, Administration and Legal (20%)	\$66,794,000
Environmental & Archaeology Studies and Mitigation	\$7,437,000
Land Acquisition and Surveying (87 acres)	\$71,799,000
Interest During Construction (4% for 4 years with a 4% ROI)	<u>\$38,401,000</u>
<b>TOTAL COST OF PROJECT</b>	<b>\$518,405,000</b>
<b>OPERATION AND MAINTENANCE COSTS</b>	
Pipelines (1% of Cost of Facilities)	\$664,000
Pump Stations and Storage Tanks (3% of Cost of Facilities)	\$1,288,000
Water Treatment Plant (12% of Cost of Facilities)	\$17,403,000
Pumping Energy Costs (19.9M kW-hr @ 0.072 \$/kW-hr)	\$1,436,000
Treatment Energy Costs (5M kW-hr @ 0.067 \$/kW-hr)	\$335,000
Purchase of Water (18,250 MG/yr @ 8.00 \$/MG)	<u>\$146,000</u>
<b>TOTAL ANNUAL O&amp;M COST</b>	<b>\$21,272,000</b>
<b>DEBT SERVICE COSTS</b>	
Pipelines Debt Service	\$11,934,000
Pump Stations including Intake Debt Service	\$3,968,000
Storage Tanks Debt Service	\$1,955,000
Water Treatment Plant including Intake and Clearwell Storage Debt Service	\$19,971,000
Miscellaneous Debt Service	<u>\$317,000</u>
<b>TOTAL ANNUAL DEBT SERVICE COST</b>	<b>\$38,145,000</b>
<b>TOTAL ANNUAL COST</b>	<b>\$59,417,000</b>



**Table 21. Surface Water Scenario 3 Costs**

<b>Cost Estimate Summary</b>	
<b>Surface Water Scenario 3, 40 MGD Minnesota River WTP, Provides 2040 Peak Demand Capacity to Apple Valley, Southern Zone of Eagan, and Rosemount</b>	
<b>Item</b>	<b>Estimated Costs for Facilities</b>
<b>CAPITAL COSTS</b>	
Intake and Pump Station (40 MGD)	\$5,564,000
Transmission Pipeline (14 miles)	\$31,199,000
Transmission Pump Station(s) (40 MGD)	\$14,312,000
Storage Tanks and Control-Meter Vaults (5.5 MG)	\$7,069,000
Water Treatment Plant (40 MGD) and Intake and Clearwell Storage (74 MG)	\$121,669,000
Miscellaneous (Integration, etc.)	<u>\$1,798,000</u>
<b>TOTAL COST OF FACILITIES</b>	<b>\$181,611,000</b>
<b>PROJECT COSTS</b>	
Design Contingencies (30%)	\$54,483,000
Engineering, Administration and Legal (20%)	\$47,219,000
Environmental & Archaeology Studies and Mitigation	\$6,479,000
Land Acquisition and Surveying (60 acres)	\$40,460,000
Interest During Construction (4% for 4 years with a 4% ROI)	<u>\$26,421,000</u>
<b>TOTAL COST OF PROJECT</b>	<b>\$356,673,000</b>
<b>OPERATION AND MAINTENANCE COSTS</b>	
Pipelines (1% of Cost of Facilities)	\$312,000
Pump Stations and Storage Tanks (3% of Cost of Facilities)	\$931,000
Water Treatment Plant (12% of Cost of Facilities)	\$14,110,000
Pumping Energy Costs (16.9M kW-hr @ 0.072 \$/kW-hr)	\$1,220,000
Treatment Energy Costs (4M kW-hr @ 0.067 \$/kW-hr)	\$268,000
Purchase of Water (14,600 MG/yr @ 8.00 \$/MG)	<u>\$117,000</u>
<b>TOTAL ANNUAL O&amp;M COST</b>	<b>\$16,958,000</b>
<b>DEBT SERVICE COSTS</b>	
Pipelines Debt Service	\$5,365,000
Pump Stations including Intake Debt Service	\$2,958,000
Storage Tanks Debt Service	\$1,523,000
Water Treatment Plant including Intake and Clearwell Storage Debt Service	\$16,175,000
Miscellaneous Debt Service	<u>\$206,000</u>
<b>TOTAL ANNUAL DEBT SERVICE COST</b>	<b>\$26,227,000</b>
<b>TOTAL ANNUAL COST</b>	<b>\$43,185,000</b>

**Table 22. Surface Water Scenario 4 Costs**

<b>Cost Estimate Summary</b>	
<b>Surface Water Scenario 4, 60 MGD Minnesota River WTP, Provides 2040 Peak Demand Capacity to Apple Valley, Eagan, and Rosemount</b>	
<b>Item</b>	<b>Estimated Costs for Facilities</b>
<b>CAPITAL COSTS</b>	
Intake and Pump Station (60 MGD)	\$7,147,000
Transmission Pipeline (15.9 miles)	\$37,072,000
Transmission Pump Station(s) (60 MGD)	\$20,480,000
Storage Tanks and Control-Meter Vaults (7 MG)	\$9,158,000
Water Treatment Plant (60 MGD) and Intake and Clearwell Storage (123 MG)	\$177,252,000
Miscellaneous (Integration, etc.)	\$2,511,000
<b>TOTAL COST OF FACILITIES</b>	<b>\$253,620,000</b>
<b>PROJECT COSTS</b>	
Design Contingencies (30%)	\$76,086,000
Engineering, Administration and Legal (20%)	\$65,941,000
Environmental & Archaeology Studies and Mitigation	\$7,845,000
Land Acquisition and Surveying (72 acres)	\$47,883,000
Interest During Construction (4% for 4 years with a 4% ROI)	\$36,111,000
<b>TOTAL COST OF PROJECT</b>	<b>\$487,486,000</b>
<b>OPERATION AND MAINTENANCE COSTS</b>	
Pipelines (1% of Cost of Facilities)	\$371,000
Pump Stations and Storage Tanks (3% of Cost of Facilities)	\$1,253,000
Water Treatment Plant (12% of Cost of Facilities)	\$20,674,000
Pumping Energy Costs (20.8M kW-hr @ 0.072 \$/kW-hr)	\$1,499,000
Treatment Energy Costs (6M kW-hr @ 0.067 \$/kW-hr)	\$402,000
Purchase of Water (21,900 MG/yr @ 8.00 \$/MG)	\$175,000
<b>TOTAL ANNUAL O&amp;M COST</b>	<b>\$24,374,000</b>
<b>DEBT SERVICE COSTS</b>	
Pipelines Debt Service	\$6,288,000
Pump Stations including Intake Debt Service	\$3,920,000
Storage Tanks Debt Service	\$1,782,000
Water Treatment Plant including Intake and Clearwell Storage Debt Service	\$23,567,000
Miscellaneous Debt Service	\$288,000
<b>TOTAL ANNUAL DEBT SERVICE COST</b>	<b>\$35,845,000</b>
<b>TOTAL ANNUAL COST</b>	<b>\$60,219,000</b>

**Table 23. Surface Water Scenario 5 Costs**

<b>Cost Estimate Summary</b>	
<b>Surface Water Scenario 5, 17 MGD Mississippi River WTP, Provides 2040 Peak Demand Capacity to Inver Grove Heights and South St. Paul.</b>	
<b>Item</b>	<b>Estimated Costs for Facilities</b>
<b>CAPITAL COSTS</b>	
Intake and Pump Station (17 MGD)	\$3,740,000
Transmission Pipeline (5 miles)	\$12,124,000
Transmission Pump Station(s) (17 MGD)	\$7,575,000
Storage Tanks and Control-Meter Vaults (2.5 MG)	\$3,597,000
Water Treatment Plant (17 MGD) and Intake and Clearwell Storage (55 MG)	\$58,229,000
Miscellaneous (Integration, etc.)	\$853,000
<b>TOTAL COST OF FACILITIES</b>	<b>\$86,118,000</b>
<b>PROJECT COSTS</b>	
Design Contingencies (30%)	\$25,836,000
Engineering, Administration and Legal (20%)	\$22,391,000
Environmental & Archaeology Studies and Mitigation	\$4,651,000
Land Acquisition and Surveying (34.5 acres)	\$23,109,000
Interest During Construction (4% for 4 years with a 4% ROI)	<u>\$12,969,000</u>
<b>TOTAL COST OF PROJECT</b>	<b>\$175,074,000</b>
<b>OPERATION AND MAINTENANCE COSTS</b>	
Pipelines (1% of Cost of Facilities)	\$121,000
Pump Stations and Storage Tanks (3% of Cost of Facilities)	\$560,000
Water Treatment Plant (12% of Cost of Facilities)	\$6,537,000
Pumping Energy Costs (5.5M kW-hr @ 0.072 \$/kW-hr)	\$397,000
Treatment Energy Costs (1.7M kW-hr @ 0.067 \$/kW-hr)	\$114,000
Purchase of Water (3,205 MG/yr @ 8.00 \$/MG)	<u>\$49,000</u>
<b>TOTAL ANNUAL O&amp;M COST</b>	<b>\$7,778,000</b>
<b>DEBT SERVICE COSTS</b>	
Pipelines Debt Service	\$2,015,000
Pump Stations including Intake Debt Service	\$1,946,000
Storage Tanks Debt Service	\$1,093,000
Water Treatment Plant including Intake and Clearwell Storage Debt Service	\$7,722,000
Miscellaneous Debt Service	<u>\$98,000</u>
<b>TOTAL ANNUAL DEBT SERVICE COST</b>	<b>\$12,874,000</b>
<b>TOTAL ANNUAL COST</b>	<b>\$20,652,000</b>

**Table 24. Surface Water Scenario 6 Costs**

<b>Cost Estimate Summary</b>	
<b>Surface Water Scenario 6, 50 MGD Mississippi River WTP, Provides 2040 Average Day Capacity to Apple Valley, Burnsville, Eagan, Farmington, Inver Grove Heights, Lakeville, Rosemount, and South St. Paul</b>	
<b>Item</b>	<b>Estimated Costs for Facilities</b>
<b>CAPITAL COSTS</b>	
Intake and Pump Station (50 MGD)	\$5,626,000
Transmission Pipeline (44 miles)	\$118,803,000
Transmission Pump Station(s) (50 MGD)	\$18,213,000
Storage Tanks and Control-Meter Vaults (6.5 MG)	\$10,482,000
Water Treatment Plant (50 MGD) and Intake and Clearwell Storage (104 MG)	\$149,661,000
Miscellaneous (Integration, etc.)	\$3,028,000
<b>TOTAL COST OF FACILITIES</b>	<b>\$305,813,000</b>
<b>PROJECT COSTS</b>	
Design Contingencies (30%)	\$91,744,000
Engineering, Administration and Legal (20%)	\$79,511,000
Environmental & Archaeology Studies and Mitigation	\$7,471,000
Land Acquisition and Surveying (51 acres)	\$82,324,000
Interest During Construction (4% for 4 years with a 4% ROI)	<u>\$45,350,000</u>
<b>TOTAL COST OF PROJECT</b>	<b>\$612,213,000</b>
<b>OPERATION AND MAINTENANCE COSTS</b>	
Pipelines (1% of Cost of Facilities)	\$1,188,000
Pump Stations and Storage Tanks (3% of Cost of Facilities)	\$1,169,000
Water Treatment Plant (12% of Cost of Facilities)	\$17,403,000
Pumping Energy Costs (23.2M kW-hr @ 0.072 \$/kW-hr)	\$1,673,000
Treatment Energy Costs (5M kW-hr @ 0.067 \$/kW-hr)	\$335,000
Purchase of Water (18,250 MG/yr @ 8.00 \$/MG)	<u>\$146,000</u>
<b>TOTAL ANNUAL O&amp;M COST</b>	<b>\$21,914,000</b>
<b>DEBT SERVICE COSTS</b>	
Pipelines Debt Service	\$19,269,000
Pump Stations including Intake Debt Service	\$3,431,000
Storage Tanks Debt Service	\$1,959,000
Water Treatment Plant including Intake and Clearwell Storage Debt Service	\$20,010,000
Miscellaneous Debt Service	<u>\$348,000</u>
<b>TOTAL ANNUAL DEBT SERVICE COST</b>	<b>\$45,017,000</b>
<b>TOTAL ANNUAL COST</b>	<b>\$66,931,000</b>

**Table 25. Surface Water Scenario 7 Costs**

<b>Cost Estimate Summary</b>	
<b>Surface Water Scenario 7, 135 MGD Mississippi River WTP, Provides 2040 Peak Demand Capacity to Apple Valley, Burnsville, Eagan, Farmington, Inver Grove Heights, Lakeville, Rosemount and South St. Paul</b>	
<b>Item</b>	<b>Estimated Costs for Facilities</b>
<b>CAPITAL COSTS</b>	
Intake and Pump Station (135 MGD)	\$12,036,000
Transmission Pipeline (44 miles)	\$167,135,000
Transmission Pump Station(s) (135 MGD)	\$49,488,000
Storage Tanks and Control-Meter Vaults (17MG)	\$21,072,000
Water Treatment Plant (135 MGD) and Intake and Clearwell Storage (276 MG)	\$380,062,000
	<u>\$6,298,000</u>
<b>TOTAL COST OF FACILITIES</b>	<b>\$636,091,000</b>
<b>PROJECT COSTS</b>	
Design Contingencies (30%)	\$190,827,000
Engineering, Administration and Legal (20%)	\$165,384,000
Environmental & Archaeology Studies and Mitigation	\$13,025,000
Land Acquisition and Surveying (93 acres)	\$102,688,000
Interest During Construction (4% for 4 years with a 4% ROI)	\$88,642,000
<b>TOTAL COST OF PROJECT</b>	<b>\$1,196,657,000</b>
<b>OPERATION AND MAINTENANCE COSTS</b>	
Pipelines (1% of Cost of Facilities)	\$1,671,000
Pump Stations and Storage Tanks (3% of Cost of Facilities)	\$2,710,000
Water Treatment Plant (12% of Cost of Facilities)	\$44,679,000
Pumping Energy Costs (75M kW-hr @ 0.072 \$/kW-hr)	\$5,441,000
Treatment Energy Costs (13.5M kW-hr @ 0.067 \$/kW-hr)	\$905,000
Purchase of Water (49,275 MG/yr @ 8.00 \$/MG)	\$394,000
<b>TOTAL ANNUAL O&amp;M COST</b>	<b>\$55,800,000</b>
<b>DEBT SERVICE COSTS</b>	
Pipelines Debt Service	\$25,131,000
Pump Stations including Intake Debt Service	\$7,890,000
Storage Tanks Debt Service	\$3,284,000
Water Treatment Plant including Intake and Clearwell Storage Debt Service	\$50,959,000
Miscellaneous Debt Service	\$723,000
<b>TOTAL ANNUAL DEBT SERVICE COST</b>	<b>\$87,987,000</b>

The annual \$/1,000 gallon unit costs for each of the surface water supply scenarios were determined, and are summarized in Table 26. These represent the costs that a utility owner could expect for surface water facilities if the project was implemented, including the costs for repayment of borrowed funds (debt service), operation and maintenance costs of the project facilities, pumping and treatment power costs, and water use fees, if applicable. These costs do not represent costs associated with development of groundwater sources where surface water is provided for a portion of the demands in the study area. Including costs for groundwater facilities would increase estimates for Surface Water Scenarios 1, 3, 4 and 5. The cost model input factors that were used to determine the \$/1,000 gallon unit costs are described in more detail in Appendix A6.

**Table 26. Summary of Annual Costs for Drinking Water Supply Scenarios**

Scenario	Estimated Annual Cost (\$/1,000 gal)
Surface Water Scenario 1	\$ 3.23
Surface Water Scenario 2	\$ 3.26
Surface Water Scenario 3	\$ 2.96
Surface Water Scenario 4	\$ 2.75
Surface Water Scenario 5	\$ 3.34
Surface Water Scenario 6	\$ 3.67
Surface Water Scenario 7	\$ 2.92

### **Water Quality Considerations Associated with Water Supply Scenarios**

A water quality and treatment evaluation of potential surface water sources in the Southeast Metro Study Area was performed. The analysis included a review raw water quality data from potential source waters, as well as typical water quality from the cities in the study area.

Representative raw water quality data for the Mississippi River at St. Paul and the Minnesota River at Burnsville were collected and evaluated to determine treatment requirements to integrate new surface water supplies into existing infrastructure without degrading the current finished water quality expected by the communities. Blended water quality was modeled to identify potential issues associated with combined surface water – groundwater systems or conjunctive use systems. Strategies to address water quality issues associated with blending were discussed. Data and discussion related to the water quality evaluation are included in Appendix A7.

The water quality and water treatment evaluation included the eight communities in the southeast Metro Study Area: Apple Valley, Burnsville, Eagan, Farmington, Inver Grove Heights, Lakeville, Rosemount, and South St. Paul. Water quality data for the Mississippi River and Minnesota River are summarized in Table 27.

## SOURCE WATER TREATMENT

Lime softening is a common treatment practice for source waters with similar water quality to the Mississippi and Minnesota Rivers. The lime softening process removes hardness components from the raw water and is robust enough to provide removal of seasonal raw water turbidity (suspended solids) and provides for some organic carbon removal. In the Twin Cities area, both Minneapolis Water and Saint Paul Regional Water Services systems provide lime softening treatment, followed by varied filtration processes. The City of Mankato, located approximately 70 miles upstream of the Twin Cities on the Minnesota River, uses lime softening to treat a blend of Minnesota River and Blue Earth River water supplied through horizontal collector wells. For consistency with the region's water treatment practices, lime softening of either the Mississippi River or Minnesota River water is evaluated in this study.

## EXISTING SYSTEM WATER SUPPLY AND TREATMENT PRACTICES

The communities within the Southeast Metro Study Area currently provide drinking water to their customers through independent, municipally-owned and operated water systems (Metropolitan Council, 2010). A variety of groundwater sources are used in the area, including the Prairie du Chien/Jordan, Mount Simon/Hinckley, and Tunnel City-Wonewoc aquifers. Water treatment practices vary from minimal disinfection, fluoridation and iron sequestration (the addition of a compound to form complex bond with metal ions allowing the metal ions to remain in solution despite the presence of precipitation agents) to iron and manganese filtration. Burnsville's treatment process for the quarry water includes direct filtration and meets the requirements of the Surface Water Treatment Rule<sup>5</sup>. Table 28 summarizes the current source of supply and treatment practices in the study area.

The Minnesota Department of Health provided the operating water quality data for the study area communities. Water quality data for each community, including standard parameters and disinfection by-products are listed in Appendix A7.

**Table 27. Water Quality Summary for the Mississippi and Minnesota River Systems**

Parameter	Units	Mississippi River	Minnesota River
Temperature	Deg C	0 - 30	9.5 - 28
Specific Conductance	uS/cm @25C	300 - 750	600 - 900
pH	units	7.4 - 8.8	7.5 - 8.5
Alkalinity, Total	mg/L as CaCO <sub>3</sub>	130 - 240	210 - 220
Chloride	mg/L	7 - 35	5 - 32
Sulfate	mg/L	20 - 140	170 - 200
Fluoride	mg/L	0.1 - 0.3	0.27 - 0.29
Total Hardness	mg/L as CaCO <sub>3</sub>	160 - 340	340
Calcium	mg/L	90 - 210	180
Magnesium	mg/L	40 - 150	65

<sup>5</sup> Surface Water Treatment Rule (SWTR) – 40 CFR 141.70-141.75

Parameter	Units	Mississippi River	Minnesota River
Iron	ug/L	160 - 440	NA
Manganese	ug/L	10 - 300	NA
Ammonia	mg/L as N	0.4 - 1.6	0.4 - 1.6
Nitrate	mg/L as N	0.0 - 4.7	0.1 - 1.6
Total Organic Carbon	mg/L	5 - 21	5.8 - 16
Total Trihalomethane	ug/L	NA	NA
Haloacetic Acid (5)	ug/L	NA	NA

**Notes:**

NA – Not analyzed

Data for the Minnesota River is not as complete as the Mississippi River.

**Table 28. Southeast Metro Study Area Water Supply and Treatment Practices**

Water System	Existing Source of Supply	Existing Treatment
Apple Valley	Groundwater	Iron and Manganese Filtration
Burnsville	Groundwater Surface Water	Iron and Manganese Filtration Direct Filtration
Eagan	Groundwater	Iron and Manganese Filtration
Farmington	Groundwater	Disinfection, Fluoridation
Inver Grove Heights	Groundwater	Iron and Manganese Filtration
Lakeville	Groundwater	Iron and Manganese Filtration
Rosemount	Groundwater	Disinfection, Fluoridation, Sequestration
South St. Paul	Groundwater	Fluoridation

**POTENTIAL IMPACT OF INCORPORATING WATER SUPPLY FROM MISSISSIPPI OR MINNESOTA RIVER SOURCE**

Finished water quality from Mississippi or Minnesota River source waters treated with a lime softening process is anticipated to be of similar quality to existing surface water treatment systems, including the water supplied by the Saint Paul Regional Water Services. The water quality for Saint Paul Regional Water Services was used to represent projected treated water quality from a surface water treatment plant considered in this study. In general, the treated surface water quality would be softer and would have a higher pH than the water customers in the study area are accustomed. A conversion from groundwater supply to softened surface water supply might result in taste and odor complaints from customers due mainly to the difference in source water. The use of home water softeners could be discontinued with the provision of treated surface water. Additionally, a surface water treatment system would provide secondary disinfection with chloramines to reduce the potential for disinfection byproduct formation due to excessive water age that may be present in a regional water system.



### **ISSUES FOR CONJUNCTIVE USE, SURFACE WATER SUPPLEMENTED BY GROUNDWATER**

Conjunctive use of surface water and groundwater scenarios in this report include base, or average day supply from a regional surface water system supplemented with groundwater supply to meet demands above average day demand capacity. Many of the same water treatment issues associated with converting from groundwater to surface water sources also apply to conjunctive use. This includes the consideration for changing disinfection practices from free chlorine to chloramines.

For conjunctive use systems where surface water is supplemented by groundwater, the groundwater disinfection should be converted to chloramination, including an ammonia feed system to provide continuous chloramine disinfection. This is necessary for the following reasons (EPA):

1. If chlorine to ammonia-nitrogen ratios are between 3:1 and 5.5:1, disagreeable tastes and odors may occur resulting in customer complaints. For systems that supplement surface water supplies with groundwater during high water demand periods, taste and odor complaints will most commonly occur at the interface where groundwater supplies with free chlorine blend with the chloraminated surface water.
2. Mixing at the point of application greatly affects the bacterial efficiency of the chloramine process. When the pH of the water is between 7 and 8.5, the reaction time between ammonia and chlorine is practically instantaneous. If chlorine is mixed slowly into ammoniated water, organic matter, especially organic matter prone to bleaching with chlorine solution, may react with the chlorine and interfere with chloramine formation.

Other issues to be considered when converting systems to chloramines include:

1. When chlorinated water is blended with chloraminated water, the chloramine residual will decrease after the excess ammonia has been combined and monochloramine is converted to dichloramine and nitrogen trichloride. The entire residual can be depleted. Therefore, it is important to know how much chlorinated water can be blended with a particular chloraminated water stream without significantly affecting the monochloramine residual.
2. Users of kidney dialysis equipment are the most critical group that can be impacted by chloramine use. Chloramines can cause methemoglobinemia and adversely affect the health of kidney dialysis patients if chloramines are not removed from the dialysate water.
3. Chloramines can be deadly to fish. The residuals can damage the gill tissues, enter the red blood cells, and cause an acute blood disorder. Chloramine residuals should be removed from the water prior to the water contacting any fish. As such, fish hobbyists should be notified, along with pet stores and aquarium supply establishments.

The best scenario for conjunctive use systems is to introduce all water supplies at the same point of entry to the distribution system. Unless the supplemental groundwater supply entry point to each municipal distribution system is the same as the surface water entry point, mixing will not occur uniformly throughout the distribution system. The blend will move through the distribution system as groundwater is introduced.

The water quality at this interface will be variable and may be a source of customer complaints ranging from turbid water to taste and odor complaints.

Blending of waters can cause excessive scale or corrosion in metal pipes. This includes steel, ductile/cast iron and copper, lead and zinc plumbing products. Several indices are used to describe the corrosion and scaling potential of water including the Langelier Saturation Index (LSI), Ryznar Index (RI), and Aggressive Index (AI). These indices are described in detail in Appendix A7. A key to indices is summarized in Table 29.

Table 29 summarizes the corrosive/scaling indices for the water systems in the study area, including representative parameters for a softened surface water source.<sup>6</sup> Table 31 lists water quality indicators that could occur assuming a 50:50 blend of softened surface water and groundwater in a conjunctive use system. This analysis represents a potential worst case condition where the two waters would interface in a distribution system. Comparing the indices of the two tables, it appears that there will be little change in the corrosive/scaling nature of the water resulting from blending the waters. The softened waters appear to actually reduce the corrosion potential of the copper, lead, and zinc plumbing materials. However, in all instances presented in Table 30 and Table 31, the lead drinking water standard (>0.015 mg/L) has the potential to be exceeded. If sufficient lead service lines are present in the distribution system, adding orthophosphate to the water could be used to minimize lead corrosion.

---

<sup>6</sup> Burnsville, Eagan, and Rosemount were not included in the listing because the MDH dataset did not include calcium or magnesium concentrations necessary for analysis. However, because of the similar source and treatment practices, it is reasonable to assume that the results would be similar to those presented for other groundwater systems.

**Table 29. Corrosion Scale Indices Key**

<b>Key to Corrosion Indices</b>
Aggressive Index (AI)
AI > 12, water is nonaggressive
AI = 10 – 11.9, water is moderately aggressive
AI < 10, water is very aggressive
Ryznar Index (RI)
RI < 6 the scale tendency increases as the index decreases
RI > 7 the calcium carbonate formation probability does not lead to a protective corrosion inhibitor film
RI > 8, mild steel corrosion becomes an increasing problem
Langelier Saturation Index (LSI)
LSI = 0, water is balanced
LSI > 0, water is scale forming (nonaggressive)
LSI < 0, water is not scale forming (aggressive)
Metal Corrosion Parameters <sup>1</sup>
Copper (Cu): 1.3 mg/L
Lead (Pb): 0.015 mg/L
Zinc (Zn): 5 mg/L

**Notes:**

<sup>1</sup> These concentration values are not MCL's, but are indicators of the potential of the water to leach these metals from new pipes fabricated of these metals. Other factors, such as age of the pipe, impact the actual corrosion. Periodic testing of water supplies at the point of use is required to determine compliance with the Lead and Copper Rule.

**Table 30. Corrosion/Scaling Indices for Regional Water Supplies**

<b>Water System</b>	<b>pH</b>	<b>AI</b>	<b>RI</b>	<b>LSI</b>	<b>Cu (mg/L)</b>	<b>Pb (mg/L)</b>	<b>Zn (mg/L)</b>
Saint Paul Regional Water System	9.01	14.3	7.84	1.46	0.001	0.985	0.05
Apple Valley	7.44	12.2	7.16	0.14	0.171	0.1445	1.89
Farmington	7.67	12.3	7.05	0.31	0.123	0.1493	0.78
Inver Grove Heights	7.50	12.1	7.3	0.1	0.159	0.1413	1.53
Lakeville	7.82	12.5	6.75	0.53	0.108	0.1516	0.44

**Notes:**

AI = Aggressive Index; RI = Ryznar Index; LSI = Langelier Saturation Index; Cu = Copper Dissolution potential; Pb = Lead Dissolution potential; Zn = Zinc Dissolution Potential

**Table 31. Corrosion/Scaling Indices After 50:50 Blend of Groundwater with Surface Water**

<b>Water System</b>	<b>pH</b>	<b>AI</b>	<b>RI</b>	<b>LSI</b>	<b>Cu (mg/L)</b>	<b>Pb (mg/L)</b>	<b>Zn (mg/L)</b>
Apple Valley	7.56	11.9	7.79	-0.11	0.116	0.1498	1.38
Farmington	7.82	12.1	7.64	0.09	0.081	0.1516	0.52
Inver Grove Heights	7.62	11.8	7.88	-0.13	0.106	0.1481	1.1
Lakeville	7.98	12.3	7.32	0.33	0.068	0.1526	0.29
South Saint Paul	7.36	11.7	7.94	-0.29	0.145	0.1548	2.75

**Notes:**

AI = Aggressive Index; RI = Ryznar Index; LSI = Langelier Saturation Index; Cu = Copper Dissolution potential; Pb = Lead Dissolution potential; Zn = Zinc Dissolution Potential

# Enhanced Recharge

## Introduction

Groundwater recharge is defined as the inflow of water to a groundwater reservoir from the land surface. Natural groundwater recharge usually refers to the natural infiltration of precipitation to the water table (USGS, 2015). Enhanced groundwater recharge refers to engineered systems designed to infiltrate surface water into the zone of saturation, with the express purpose of increasing the amount of groundwater stored in the aquifer.

The objective of the enhanced recharge analysis was to perform an initial screening of the study area to identify areas where water applied at the surface would have the highest potential to recharge bedrock aquifers. Emphasis was given to recharge of permeable bedrock formations since the majority of the groundwater used in the study area for municipal supply comes from these sources. Other potential benefits of enhanced recharge, such as impact on sensitive surface water features, were not specifically evaluated as part of the study.

The enhanced recharge analysis was expanded beyond the eight communities of the Southeast Metro Study Area to include all of Dakota County. The analysis also included Mendota Heights and West St. Paul, which were excluded from the drinking water supply scenarios because they are currently served by Saint Paul Regional Water Services through long-term water supply contracts. The study expansion allowed better assessment of the benefits of regional recharge on the local aquifers.

Methodology and results of the enhanced groundwater recharge study are described in the following sections. General concepts related to enhanced recharge, including implementation of groundwater recharge projects, are also discussed. Suggestions for data refinements that would facilitate more detailed analysis of location-specific recharge opportunities within the study area are also provided. Although the recharge criteria and analysis did not identify a specific water source for groundwater recharge, an assessment of stormwater as a potential recharge water source is considered in a subsequent section of this report.

## Recharge and Infiltration

Recharge and infiltration are similar processes in that both refer to the hydrologic process by which water at the surface enters and percolates through the soil. Recharge refers to the water that infiltrates past the root zone, into the saturated zone, and eventually reaches groundwater sources. Not all water that infiltrates will necessarily recharge the water table.

Although there are state and local policies that encourage or require infiltration as a stormwater management practice, these policies are designed primarily to manage runoff rate and volume and protect the quality of receiving water bodies. While some portion of infiltrated stormwater can and may eventually reach the water table, aquifer recharge is not generally the primary goal of most stormwater management practices. For example, Minnesota's Minimal Impact Design Standards (MIDS) encourages a low-impact development approach to stormwater management, where water is kept on the landscape, mimicking pre-development hydrology. Under the MIDS guidelines, infiltration is used to offset the hydrologic effects of creating new or redeveloped impervious area (MPCA, 2015a).

While groundwater recharge can be an incidental benefit of the low-impact development approach, it is not usually the primary driver for the practice. Enhanced groundwater recharge at the scale that is considered in this study is typically done with constructed facilities that have the specific purpose of increasing the recharge to groundwater supplies.

### **Benefits of Enhanced Groundwater Recharge**

The objective of this study was to evaluate the potential to enhance groundwater recharge to drinking water aquifers in the study area. In addition to the direct benefit to aquifers, enhanced groundwater recharge can provide other water resource benefits. The following list describes potential benefits to surface water from enhanced groundwater recharge:

- Enhanced recharge near surface water bodies can offset the lateral drawdown effects of pumping from nearby wells.
- Enhanced recharge near surface water bodies can offset the loss of water due to lower potentiometric heads in underlying aquifers. Surface water bodies can be losing water from deeper portions while receiving recharge from groundwater in shallow portions.
- Enhanced recharge near surface water bodies can improve the quality of the water that ultimately recharges the surface water body (as opposed to direct overland flow to the surface water body).
- Enhanced recharge can raise the water table over the long-term, reversing the lowering of water levels in surface water bodies.

Stormwater is a potential recharge water source. Capturing stormwater for enhanced recharge may provide benefit not only to bedrock aquifers, but also the unconsolidated aquifers and surface water bodies that are vulnerable to changes in groundwater level. A key component to enhancing recharge to any groundwater resource is providing a net addition of water to the system, which could be accomplished by capturing stormwater runoff before it leaves the local watershed.

### **Methodology**

The general methodology for the enhanced groundwater recharge analysis included four steps.

- **Data Collection.** Data relevant to infiltration criteria were collected from various sources including publicly-available Geographic Information System (GIS) datasets from local, state and national agencies. Data were placed into the several categories including geology/hydrogeology, land use/natural resources, drinking water protection, and contamination sites.
- **Data Processing.** Although most datasets were incorporated into the study “as-is” with no manipulation, processing of some datasets was required to reach project goals.
- **Criteria Development.** Criteria were developed to identify and rank locations where enhanced recharge might be suitable or unsuitable. Geology, hydrogeology, and land use criteria were partially developed with input from Metropolitan Council Environmental Services (MCES) personnel, Minnesota Pollution Control Agency (MPCA), Minnesota Department of Natural Resources (MnDNR), Minnesota Board of Water and Soil Resources (BWSR), United States Geological Survey (USGS), and Minnesota

Geological Survey (MGS). Drinking water protection criteria were developed with input from the Minnesota Department of Health (MDH).

- **Data Calculation.** The datasets were imported into GIS and new subsets of data were identified at the intersection of specific criteria. Polygons were created to identify the areas where specific features or portions of features from the various datasets overlapped. These areas were then classified as follows:
  1. *Tier 1* subsets from each of the various datasets were merged to show the overall area where recharge is likely to be most successful. For an area to be deemed Tier 1, all of the criteria for a Tier 1 recharge location need to be met.
  2. *Tier 2* subsets from each of the various datasets were merged to show the overall area where recharge could feasibly occur. For an area to be deemed Tier 2, all of the criteria for a Tier 2 recharge location need to be met.
  3. *Tier 3* subsets from each of the various datasets were merged to show the overall area where recharge is not feasible under the criteria established for this study. For an area to be deemed Tier 3, any one of the criteria for a Tier 3 recharge location needs to be met.

Appendix A8 includes a detailed description of the enhanced recharge study methodology, including a complete description of the data sets and data processing (Tables A8-1 and A8-2), and the criteria and rationale (Tables A8-3 and A8-4) used to evaluate feasibility for recharge areas.

## Results

Two approaches were taken to evaluate the recharge potential in the study area. The first approach used hydrogeological criteria to identify areas where water could infiltrate and potentially reach a bedrock drinking water aquifer, without consideration for the current land use or other human- or environmental-influenced limitations. The second approach expanded the hydrogeological approach to incorporate land use, sensitive natural resource areas, and drinking water protection areas into the data calculation. GIS-based maps were generated for each approach. Figure 21 shows the results using only the hydrogeological criteria, and Figure 22 shows the results using all criteria. Each figure includes a summary of the criteria used to generate the figures.

The total Tier 1 and Tier 2 area using all (expanded) criteria is summarized in Table 32, with breakdowns of the Tier 1 and Tier 2 areas by municipality shown in Table 33. The Tier 1 and Tier 2 recharge areas are concentrated in Rosemount, Inver Grove Heights, and portions of Eagan. Rosemount and Inver Grove Heights have appreciable amounts of agricultural and undeveloped land that may be available for construction of infiltration basins; whereas Eagan's potentially available areas are a mixture of undeveloped land and parks. Reasonable opportunities for enhanced recharge also exist in Apple Valley, Burnsville, and Lakeville. Recharge opportunities appear limited in Farmington, Mendota, Mendota Heights, Lilydale, South St. Paul, Sunfish Lake, and West St. Paul.

**Table 32. Tier 1 and Tier 2 Areas in the Study Area for Enhanced Recharge Using All Criteria**

<b>Enhanced Recharge</b>	<b>Acres</b>	<b>% of Study Area</b>
Tier 1 Area	4,652	3%
Tier 2 Area	25,403	18%

**Table 33. Tier 1 and Tier 2 Areas for Enhanced Recharge in Municipalities Using All Criteria**

<b>Municipality</b>	<b>Tier 1 Recharge Area (acres)</b>	<b>Tier 2 Recharge Area (acres)</b>
Apple Valley	1	1,541
Burnsville	106	672
Eagan	717	3,071
Farmington	0	621
Inver Grove Heights	1,415	6,591
Lakeville	2	846
Mendota	0	25
Mendota Heights	31	254
Rosemount	2,379	11,699
South St. Paul	1	49
Sunfish Lake	0	21
West St. Paul	0	11

Table 34 lists the recharge areas by watershed jurisdiction. The Tier 1 and Tier 2 areas occur primarily in the following watershed organizations: Eagan-Inver Grove Heights Watershed Management Organization, Lower Mississippi River Watershed Management Organization, and Vermillion River Watershed Joint Powers Organization. The boundaries of the watershed organizations are shown on Figure 23. A discussion of the role of the municipality or watershed organization in the development of infiltration basins is provided in the following section, *Enhanced Groundwater Recharge Implementation*.



**Table 34. Tier 1 and Tier 2 Areas for Enhanced Recharge in Watersheds Using All Criteria**

<b>Watershed Jurisdiction</b>	<b>Tier 1 Recharge Area * (acres)</b>	<b>Tier 2 Recharge Area * (acres)</b>
Lower Minnesota River Watershed District	12	181
Black Dog Lake Watershed Management Organization	98	555
Credit River Watershed Management Organization	0	296
Eagan-Inver Grove Heights Watershed Management Organization	781	3,216
Lower Mississippi River Watershed Management Organization	1,380	6,673
Vermillion River Watershed Joint Powers Organization	2,385	14,489

Notes:

\* Includes Study Area only.

From the standpoint of groundwater supply, enhanced recharge could potentially benefit areas of greatest drawdown in a drinking water aquifer. Aquifer drawdown was not specifically used as a criterion for enhanced recharge in this study, but could be taken into consideration in prioritizing areas for future investigation. In the Southeast Metro Study Area, the Prairie du Chien-Jordan aquifer is the primary drinking water supply aquifer. Figure 24 shows the Tier 1, Tier 2, and Tier 3 areas for enhanced recharge (using all criteria) with projected 2040 groundwater drawdown in the Prairie du Chien aquifer estimated using the Metro Model 3 groundwater model (Metropolitan Council, 2015). Portions of Apple Valley, Eagan, and Inver Grove Heights have Tier 1 or Tier 2 areas that overlie locations where drawdown in the Prairie du Chien-Jordan is projected to exceed 10 feet in 2040 with continued development of groundwater resources.

## **Enhanced Groundwater Recharge Implementation**

### **ENHANCED RECHARGE METHODS**

Enhanced recharge is the focused infiltration of water from the surface into the zone of saturation with the express purpose of recharging an aquifer(s) using an engineered system.

There are three basic methods of enhanced recharge including surface infiltration basins, sub-surface infiltration systems, and direct aquifer injection.

Surface infiltration systems are variously termed recharge basins, infiltration basins, and rapid infiltration basins. These are basins or systems located on the ground surface that allow water to infiltrate from an open basin into the unsaturated zone. Sub-surface infiltration systems, which include infiltration trenches, galleries, or shafts, deliver water directly into the unsaturated zone and allow infiltration down to the water table. These types of systems can be useful when preserving the surface land use is desirable, as in open space or park space, for example.

The third method of enhanced recharge, direct injection of recharge water into an aquifer using injection wells, was excluded from consideration in this study. However, the following overview of the regulation of injection wells provides important contextual information.

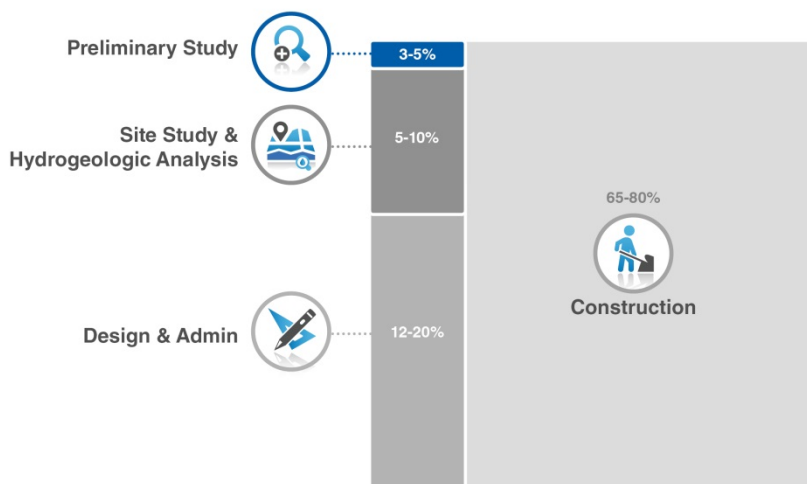
Injection wells are regulated by the EPA through the Underground Injection Control (UIC) program, which classifies wells into six types, or classes (Class I – Class VI). Because the State of Minnesota has not assumed primary enforcement authority for federal UIC regulations, EPA Region 5 directly implements the UIC program for regulating underground injection in Minnesota and for all Tribal lands in the state.

Although MDH does not directly regulate underground injection in Minnesota, the agency administers the state well code (Minnesota Administrative Rules Chapter 4725. 2050), which generally prohibits the injection of fluids into a boring or well, which would include the injection of recharge water for artificial groundwater recharge. There are currently no known systems in Minnesota that inject treated stormwater into an aquifer for enhanced recharge.

#### ENHANCED GROUNDWATER RECHARGE PROJECT DEVELOPMENT

This study represents a preliminary comparison of the hydrogeologic characteristics with criteria that would indicate the potential for enhanced recharge on a regional scale. Further analysis and planning studies would be required to assess the feasibility of constructing enhanced recharge facilities including hydrogeologic analysis and site assessments for candidate sites. Implementation would also require permitting and detailed engineering design. Chart 4 illustrates the phases required to further assess, design, and ultimately construct an enhanced recharge system, and the relative costs associated with each phase. Planning level analyses, regulatory and permitting considerations, and construction costs are discussed in subsequent sections.

**Chart 4. Enhanced Recharge Project Implementation Phases and Associated Costs**



#### **SITE STUDY AND HYDROGEOLOGIC ANALYSIS**

Planning for recharge systems should include a more detailed analysis of site-specific conditions, including hydrogeology, water quality, source water availability and characteristics, institutional and legal considerations, and operational requirements.

Geology and hydrogeology of specific areas proposed for enhanced recharge should be investigated on a more focused, local scale. Much of the geology and hydrogeology data used in this study resulted from regional-scale studies, modeling, and data sets. A site-specific study that assesses the suitability of the site, a soils investigation, and a detailed hydrogeologic analysis should be performed for candidate groundwater recharge sites. The drilling of soil borings and installation of monitoring wells will provide information needed to design a recharge basin, including the depth to groundwater and groundwater flow direction, hydraulic conductivity and transmissivity of the aquifer, presence or absence of confining layers, infiltration rate, and background groundwater quality. There is potential that recharge water may not reach targeted groundwater resources, perhaps due to the presence of impermeable strata, or horizontal 'short-circuiting' of groundwater flow to a surface water body. Modeling studies should be performed to assess groundwater mounding potential and the recharge contribution to unconsolidated and bedrock aquifers. A certain minimum vertical distance between the seasonally high water table (or bedrock surface) and the bottom of the basin would need to be maintained in order for the recharge basin to drain properly and to provide a zone of treatment. MPCA (2015b) requires at least 3 feet of vertical separation, and local authorities may require greater separation depths.

Existing groundwater contamination may also limit the potential to perform groundwater recharge at specific sites. A closer examination of past and present contaminated areas should be performed, as these were not used as specific screening criteria, and the movement of contaminant plumes in the study area would be of concern. The contaminant information used in this study included the State Water Use Database System (SWUDS) and MPCA and MDA inventories, which are primarily provided as point locations, and Special Well and Boring Construction Areas (SWBCAs). Smaller contaminant plumes may exist that were not identified in this regional study. More investigation into the nature and extent of contaminant plumes is recommended if specific parcels are identified for recharge projects. MDH and MPCA should be consulted to confirm that recharge basins are not located within a SWBCA or other drinking water protection area, or in the vicinity of a contaminant plume. Potential impacts on vulnerable drinking water supplies and the movement of contaminant plumes should be assessed, and travel times from the recharge basin to nearby public water supply wells and contaminant plumes should be estimated.

Source water quality and quantity should also be further evaluated. Source water quality and potential movement and treatment of source water through the subsurface will determine the overall feasibility of, and treatment and monitoring requirements for, specific recharge applications. Source water quantity and reliability will factor into the recharge basin feasibility and design.

While this study included general identification of threatened and endangered (T&E) species areas, the individual species and potential construction requirements associated with the species would need to be identified in coordination with the MnDNR on a site-specific basis. The planning phase for a recharge basin should include a T&E record search and the findings reviewed by the MnDNR. The MnDNR may require a Determination of Effects if T&E species are indicated in the project area. Criteria used for the determination may include:

- Presence/absence of appropriate habitat;
- Presence/absence of species observations within the project area;
- Potential to avoid and minimize impacts through timing restrictions and best management practices; and
- Level of potential impact in relation to known species populations.

Some habitats may be off-limits to construction in T&E species areas, whereas other areas may be acceptable if certain mitigation measures are taken. The MnDNR would ultimately decide whether construction of a recharge basin would be allowed in a T&E species area, and would be the approving body for any potential mitigation measures.

#### **REGULATIONS AND PERMITTING**

Recharge basins are regulated by local water management districts, cities (or counties), and the MPCA as part of the Stormwater Program. This program administers both the federal Clean Water Act and the State Disposal System. The program includes three types of stormwater permits: the Municipal Separate Storm Sewer System (MS4) permit, the Construction Stormwater Permit, and the Industrial Stormwater Permit. These permits are required for projects disturbing more than one acre. MPCA's Stormwater Program website (MPCA, 2014b) describes permit requirements related to infiltration practices and provides more information about these types of permits. MPCA's Stormwater Manual contains guidance and requirements for design, construction, and operation of recharge basins. Watershed management organizations and districts may have local regulatory authority over the construction of recharge basins. Permits are typically obtained through the city within which the site is located, and cities may include infiltration guidance from their respective watershed district. The districts typically rely on MPCA and MDH guidance but may have additional criteria based upon their own requirements and needs.

Should a proposed site for a recharge basin lie within a Wellhead Protection Area (WHPA) or a Drinking Water Supply Management Area (DWSMA), MDH should be consulted for the latest guidance. MDH does not regulate the construction or management of recharge basins but has published guidance (MDH, 2007) related to infiltration of stormwater and encourages care in planning these types of projects, especially within a vulnerable DWSMA. A vulnerable DWSMA involves criteria such as overlying a sub-cropping fractured or karst aquifer with less than 100 feet of overburden, the land use of the basin's watershed, and contaminants of concern in the stormwater. In addition, MDH designates SWBCAs in areas where groundwater contamination has, or may, result in risks to the public health. Although the SWBCA rules pertain to drilling or modification of public and private water supply wells, and monitoring wells, MDH should be consulted about proposed recharge basin sites that lie within these areas.

### ENHANCED RECHARGE IMPLEMENTATION COSTS

Conceptual level costs were developed for a range of recharge basin sizes and design considerations. These costs, shown in Table 36, show a low range and a high range of capital costs for surface recharge basins. The low range costs were based on a traditional above-ground recharge basin conceptual design. The high range costs were based on a recharge basin system with sub-surface distribution chambers. A detailed breakdown of the costs for representative recharge basin sizes and design concepts as well as cost assumptions are included in Appendix A9.

**Table 35. Estimated Capital Cost for Recharge basins**

Recharge Basin Area (acres)	Cost <sup>1</sup>
10	\$1,700,000 - \$4,600,000
20	\$3,400,000- \$9,000,000
40	\$6,700,000- \$17,800,000
60	\$9,900,000 - \$26,700,000
80	\$13,300,000 - \$35,500,000

**Notes:**

<sup>1</sup> Costs include construction costs, construction contingency (30%), engineering, permitting and administrative costs (20%). Costs do not include land acquisition or landscaping improvements other than site restoration.

Costs will vary depending on a number of considerations, including:

- Type and final design of recharge basin;
- Local site conditions;
- Soil amendment requirements;
- Type of recharge system (traditional recharge basin, trenched system, buried chamber system);
- Source water conveyance to the site;
- Source water treatment requirements;
- Land or property acquisition costs; and
- Regulatory and permitting requirements.

Operations and maintenance costs were not included in these cost estimates, but should be considered when evaluating the type of system for implementation. Operations costs may be related to pumping, treatment system operation, and water quality sample collection and analysis. Maintenance costs may include inspection and maintenance of pipelines, regular upkeep of the recharge basins, and landscaping maintenance. Rehabilitation of recharge basins may be necessary over the life of the facility. This may include replacement of the sand or native soil layers to restore infiltration capacity lost to clogging by plant or bacterial growth for surface systems, or replacement of the chamber systems for those types of facilities.

# Stormwater Capture and Reuse

## Introduction

Stormwater capture and reuse refers to the large-scale diversion and collection of stormwater runoff for beneficial use. The objective of the stormwater capture and reuse component of this regional study was to evaluate the potential for stormwater reuse to offset the demand for groundwater from non-potable users (both municipal customers and private appropriation permit holders). The stormwater analysis for included Mendota Heights and West St. Paul, which were excluded from the alternative drinking water supply analysis because they are currently served by Saint Paul Regional Water Services through long-term water supply contracts. The analysis also included an assessment of stormwater to serve as a water source for regional enhanced groundwater recharge.

Analysis methods and results of the stormwater capture and reuse study are described in the following sections. Suggestions for data refinements that would facilitate detailed analysis of location-specific opportunities for stormwater capture and reuse, along with considerations for implementation and general cost information are also provided. Detailed information supporting the analyses is included in Appendix A9.

## Methodology

The analysis of stormwater capture and reuse included an overall comparison of the total annual stormwater runoff volume and groundwater use in the study area, and a general assessment of stormwater availability at specific locations that use a high volume of water for non-potable applications. The analysis does not evaluate the appropriateness of captured stormwater for water uses at individual locations, or several conditionally-dependent factors that would ultimately define the potential for stormwater to meet specific demands. However, it does provide a relative assessment of a study area's potential to meet some portion of demands for non-potable use with stormwater.

An initial comparison of the total annual non-winter<sup>7</sup> runoff volume and the total groundwater demands for the study area was made to assess the overall potential of using stormwater to offset groundwater demands. Stormwater runoff volumes were calculated for all subwatersheds in the study area with a modified Rational Method, using the 30-year<sup>8</sup> average annual (non-winter) rainfall, runoff coefficients, and the area of each subwatershed. The subwatershed volumes were then aggregated to estimate runoff for the entire study area. These estimates were then compared with tabulated groundwater use to determine the overall balance of runoff to groundwater use in the study area.

---

<sup>7</sup> The annual non-winter runoff period is defined as the period from March 15 to November 31.

<sup>8</sup> The 30-year average (1981-2010) of non-winter (March 15 to November 30) precipitation from the six National Centers for Environmental Information (NCEI) rain gage stations within the study area (NCEI, 2015).

A subsequent analysis of stormwater run-on at specific high-volume use locations in the study area provided an assessment of the potential to capture and reuse stormwater as an alternative to groundwater use. High-volume users in the study area were identified by reviewing the MnDNR SWUDS database, Water Emergency and Conservation Plans (WECP or “Water Supply Plans”), and water sales data provided by municipalities within the study area. These uses were then screened to focus on non-potable uses related generally to urban irrigation. Water use for these users was tabulated. These sites were then mapped, and the drainage area to each site was delineated using ArcHydro tools within ArcGIS to determine the stormwater run-on volume that could be available for capture in proximity to each user. Computed run-on volumes were compared with historic water use for the list of users to estimate the potential groundwater offset that could be achieved with stormwater capture and use at these sites.

In addition to the stormwater computations for high-volume use sites, the stormwater run-on volumes to sites identified as meeting either Tier 1 or Tier 2 criteria for enhanced recharge (in the previous section of this report) were computed to determine the potential stormwater volume available for recharge of bedrock aquifers at these sites.

More detailed information on the methodology is included in Appendix A9.

## Results

To estimate the average annual non-winter stormwater runoff for the study area<sup>9</sup>, acreage of land cover within the study area boundary and Dakota County average yearly precipitation were used as inputs to the Rational Method for runoff calculation. Land use data for 2010 obtained from the Council (Figure 25) were correlated to similar Minnesota Land Cover Classification System (MLCCS) classes to determine runoff coefficients for the calculation. The total annual non-winter runoff for the entire study area was calculated to be 23,875 million gallons (MG).

The overall reported 2010 groundwater use for the study area, as tabulated in the MnDNR SWUDS database, is approximately 16,700 MG, or 70 percent of annual non-winter runoff. This represents both potable and non-potable uses within the study area that exceed the established MnDNR appropriation permitting threshold of 10,000 gallons per day or 1 million gallons per year with. This study focused on non-crop irrigation<sup>10,11</sup>, such as golf courses, landscaping, and athletic fields, which are especially well suited for using stormwater since they represent a significant water demand and water quality requirements are less of concern than in other applications. The total non-crop irrigation uses within the study area for 2010 totaled 257 MG, or just over one percent of annual non-winter runoff. Based on this comparison, it appears feasible that some volume of groundwater demand could be offset with stormwater capture and reuse.

---

<sup>9</sup> The study area for the stormwater use analysis included the communities of Apple Valley, Burnsville, Eagan, Farmington, Inver Grove Heights, Lakeville, Rosemount and South St. Paul. Mendota Heights and West Saint Paul were also included.

<sup>10</sup> There were only nine “Major Crop Irrigation” uses in the study area. These have a relatively small groundwater demand, and were not included in the study.

<sup>11</sup> Identification of potential stormwater use for industrial groundwater users was beyond the scope of this study.

Table 36 shows a summary of stormwater runoff, groundwater use, and non-crop irrigation use for the study area.

**Table 36. Summary of Stormwater Runoff and Groundwater Use within the Southeast Metro Study Area**

Item	Water Volume (MG)
Study Area Annual Non-Winter Stormwater Runoff	23,875
2010 Study Area Groundwater Use	16,700
2010 Non-Crop Irrigation Use from Groundwater Wells	257

The tabulation and analysis of groundwater users in the Southeast Metro Study Area resulted in the identification of 45 high-volume water users, including 28 MnDNR water use permit holders, four users listed in city WECPs, and 13 other municipal water customers. Actual 2010 water use for each user was tabulated. Table 37 shows water use in each use category for the 45 users identified in the study area. Total use in 2010 by these high-volume users totaled approximately 328 MG.

**Table 37. 2010 High-Volume Urban Irrigation Uses within the Southeast Metro Study Area**

Use Category	2010 Water Use (MG)
Private	58.69
Institutional	90.96
Golf	57.57
Residential	74.64
Industrial	18.69
Recreational	10.33
Agricultural	17.09
Total	327.97

In addition to the high-volume urban irrigation-related uses identified from MnDNR, WECP, and city water sales data, nine other sites identified as meeting Tier 1 or Tier 2 criteria for enhanced regional recharge in the previous section of this report were also included to determine the potential stormwater run-on volume available for recharge of bedrock aquifers at these sites. These nine sites were selected for this analysis for meeting various geologic, land use, and size criteria. This resulted in 54 potential stormwater use sites identified, which includes 45 existing urban irrigation sites and nine potential recharge sites. Table 38 summarizes the potential stormwater use sites by identification source category.



**Table 38. Potential Sites for Captured Stormwater Use in the Southeast Metro Study Area**

Site Identification Source	Number of Sites
MnDNR SWUDS	28
WECP/City Water Sales	17
Recharge Sites	9
Total	54

Drainage areas were delineated to determine the annual non-winter stormwater run-on volume that could be available for capture in proximity to each of the 54 sites described above. A ten-meter Digital Elevation Model (DEM) was used to define subwatersheds for the analysis. The physical locations of the 54 sites within the study area were assigned to a point that represented the furthest downslope location on the property, within proximity to a conveyance system. This point serves as the drainage area spill point. Modeled locations and drainage areas are shown in Figure 26.

Computed run-on volumes were compared with historic water use for the 45 high-volume users to estimate the potential groundwater offset that could be achieved with stormwater capture and use at these sites. Annual non-winter stormwater run-on to the 45 high-volume urban irrigation sites totaled 6,008 MG.

At 31 of the 45 sites evaluated (69%), total non-winter run-on exceeded tabulated groundwater use. At 17 of the 45 sites (38%), run-on volumes were estimated to be more than twice annual water use, showing a high potential for stormwater use. A comparison of run-on to annual use at each site is shown in Table 39.

**Table 39. Site-Specific Comparison of Run-on with Irrigation Use**

Comparison of Run-on to Use	Number of Sites	2010 Non-Winter Use (MG)
Users with Annual Run-on > 1x Annual Use	31	143
Users with Annual Run-on > 2x Annual Use	17	101

It is unlikely that all stormwater run-on to a site can be used for irrigation given the temporal nature of rain events, and site and size limitations of capture and storage systems. The volume that can be used for irrigation is driven by crop type (e.g. turfgrass), drainage area characteristics, site soils, and available space for storage, among other factors. However, if stormwater could be used to supply 50 percent of irrigation demands at the sites where run-on is estimated to be greater than two times irrigation use, more than 50 MG per year in groundwater use offsets could be achieved. This represents a 15.4% reduction in the 45 high-volume user's annual groundwater demand. For comparison purposes, the City of Farmington's 2010 total water use was 922 MG and the City of Eagan's 2010 use was 3,600 MG.

Stormwater run-on volumes were also calculated for the nine enhanced recharge zones identified as potential stormwater use sites. The drainage area delineation and hydrologic calculations estimate that 8,440 MG of stormwater flows to the nine enhanced recharge sites each year. If the total volume could be captured and infiltrated, an average of 23.1 MGD could be applied for groundwater recharge.

A comparison of stormwater run-on volume to potential use or application is shown in Table 40.

**Table 40. Table of Potential Groundwater Offsets versus Annual Run-on**

<b>Users</b>	<b>Number</b>	<b>Average Annual Stormwater Run-on (MG)</b>	<b>Potential Annual Stormwater Use (MG)*</b>
2010 High-Volume Users	45	6,008	50
Regional Enhanced Recharge Sites	9	8,440	8,440
<b>TOTAL</b>	<b>54</b>	<b>14,448</b>	<b>8,490</b>

Notes:

\*Assumes 50% of irrigation demand can be met with captured stormwater at the high-volume use sites.

#### **ADDITIONAL OPPORTUNITIES FOR DISTRIBUTED STORMWATER INFILTRATION**

In addition to the high-volume urban irrigation-related uses identified from MnDNR, WECP and city water sales data, 187 other parcels generally classified as parks, open space, or recreation in the MLCCS data for the study area assessed as potential stormwater use sites, as these could be used for distributed recharge or irrigation sites. Run-on volumes were calculated for the 187 MLCCS parcels. Nearly 8,500 MG of stormwater flows to the 187 MLCCS parcels during non-winter months on an annual basis. More detailed study of stormwater use systems could be considered as these sites develop, depending on specific site conditions.

#### **Stormwater Capture and Reuse Implementation**

Although stormwater can be captured for reuse for a variety of applications, including industrial uses, greywater uses, and even potable uses, the following discussion is focused on large-scale stormwater capture systems for outdoor urban irrigation uses. These typically include athletic field irrigation, or large-scale landscape irrigation for commercial, industrial or institutional campuses. Reuse for other applications will have varying requirements for storage, source augmentation, treatment, permitting and design.

#### **Stormwater Capture and Reuse System Components**

The most widespread non-potable use for stormwater is irrigation, which accounts for approximately 34 percent of all water use in the United States (McPherson, 2015). Stormwater capture and reuse systems for outdoor irrigation typically include collection, storage, treatment, pumping, controls and bypass components. The size and extent of each component will depend on the intended application, site characteristics, and local regulatory and permitting requirements.

Collection or diversion of stormwater from conveyance systems includes pipe networks consisting of a series of catch basins and stormwater pipes, and ditch systems. Before moving from conveyance into storage, stormwater collected for reuse will typically pass through an in-line screen to remove leaves, twigs, and other debris.

Storage typically occurs in one of three forms including pond storage, below-ground storage, and above-ground storage. Each type has advantages and disadvantages in terms of costs, land use, aesthetics, and maintenance requirements. Storage is sized to balance supply needs with variability in rain events, and must also take into consideration site constraints. Storage may also provide solids settling ahead of other treatment. An overflow system to direct runoff volumes in excess of available storage should be designed into capture and reuse systems. Because of the variable nature of rain events, back-up connections to other water supplies should be provided, as well as controls systems to monitor storage and manage pumping operations.

In systems that irrigate unrestricted access areas (or areas that are open to human use, like athletic fields or parks), treatment may also include filtration, followed by a disinfection process. Disinfection may consist of UV radiation and/or chlorination to neutralize pathogens. More detail on system components and features are discussed in Appendix A3.

## **Stormwater Capture and Reuse Project Development**

### **PLANNING LEVEL ANALYSES**

Planning for stormwater capture and reuse systems should include more detailed analysis of site-specific conditions, reuse applications, and requirements for implementation.

Further analysis of any of the stormwater capture and reuse sites included in the study could include a refined evaluation of the volume of stormwater run-on at individual sites. A more detailed analysis should consider site-specific factors including local precipitation trends, evapotranspiration, soil types and antecedent soil moisture conditions, and seasonal variability related to timing of use. The Minnesota Stormwater Manual, Stormwater Re-use and Rainwater Harvesting Section (MPCA, 2015c) presents a synthetic analysis that could serve as guidance for a more detailed evaluation of irrigation-related use. The analysis considers the capture and storage of a specific rain event, the timing between rain events and irrigation application rates to estimate the total portion of annual run-on that can be captured and used for irrigation. The need for bypass or overflow connections to existing conveyance systems should also be addressed.

Diversion of stormwater from conveyance and the impact of potentially reduced flow on downstream conditions should also be considered. Analysis of historic or natural flow patterns in the drainage area, the impact of land development on runoff volume and rate, and the percentage of drainage area to be captured, as well as a more detailed assessment of downstream receiving waters can help assess whether stormwater diversions will have net positive or net negative impacts on downstream flows and uses.

Use-specific considerations, including water quality requirements, and application rate and period should be factored into more detailed analyses of potential applications. Other factors related to infrastructure requirements, including the sizing of the storage or containment facilities, site constraints, application areas, and overflow location and capacity, among others, should be assessed in more detailed study phases and to support implementation.

#### WATER QUALITY

The quality of the source water is a major consideration in evaluating reuse systems. Stormwater may pick up any number of contaminants as it runs off the land surface. These contaminants include debris, chemical contaminants, and microbiological contaminants. Some concerns associated with the reuse of stormwater for non-potable uses include the potential for human exposure to pathogens; cross-contamination of potable water supply, ingestion of crops potentially contaminated with pathogens, concerns with mosquito breeding, and contaminated pond sediment.

Typical concentrations of urban stormwater constituents are listed in Table 41. The concentration of specific contaminants will vary with storm event, land use, and location, and data collection and monitoring should be used to determine the actual concentration of any constituent in a given watershed (Gulliver, et al, 2010).

**Table 41 Concentrations of Stormwater Constituents**

Constituent	Twin Cities, MN (Minneapolis – St. Paul) <sup>1</sup>	U.S. Cities (median for all sites) <sup>2</sup>
Total Suspended Solids (TSS) (mg/L)	184	100
Volatile Suspended Solids (VSS) (mg/L)	66	N/A
Total Phosphorous (TP) (mg/L)	0.58	0.33
Dissolved Phosphorous (DP) (mg/L)	0.2	0.12
Chemical Oxygen Demand (COD) (mg/L)	169	65
Biochemical Oxygen Demand (BOD) (mg/L)	N/A	9
Total Kjeldahl Nitrogen (TKN) (mg/L)	2.62	1.5
Nitrate Nitrogen (NO <sub>3</sub> .N) (mg/L)	0.53	0.68
Ammonium (NH <sub>4</sub> ) (mg/L)	N/A	N/A
Total Lead (mg/L)	0.060	0.144
Total Zinc (mg/L)	N/A	0.160
Total Copper (mg/L)	N/A	0.034
Total Cadmium (mg/L)	N/A	N/A

Notes:

<sup>1</sup> Stradelmann and Brezonik. 2002.

<sup>2</sup> USEPA, 1983

Treatment requirements for captured stormwater will depend on the quality of the source water and the intended use or application. For non-potable reuse of stormwater, the largest public health concern is the exposure of humans to pathogenic bacteria (i.e. Giardia, Cryptosporidium, and Salmonella) and viruses. Treatment requirements can vary depending on whether the application has restricted or unrestricted public access or whether there is the potential for human contact with the reused stormwater. Restricted stormwater reuse applications are defined by areas to which access can be controlled (private golf courses, cemeteries, highway medians). Unrestricted access area reuse applications include irrigation in parks, playgrounds, school yards, and residential areas. To limit the public health risk and exposure to pollutants, projects in unrestricted access areas will have more stringent water quality standards than projects in restricted access areas.

In Minnesota, the MPCA has developed draft water quality guidelines for stormwater harvesting and use systems used for irrigation in areas with public (unrestricted) access. In these areas the draft guidelines should be considered preliminary and used for discussion with governing agencies to solicit additional comments (MPCA, 2015c). Water quality guidelines are aimed at minimizing negative impacts to public health, plant health, and irrigation system function. State water quality guidelines for public access areas (related to outdoor irrigation) are summarized in Table 42.

**Table 42. Summary of State of Minnesota Water Quality Guidelines for Irrigation**

Water Quality Parameter	Water Quality Guideline – Public Access Areas
E. coli	126 E. coli/100 mL
Turbidity	2-3 NTU
TSS	5 mg/L
pH	6-9
Chloride	500 mg/L
Zinc	2 mg/L (long-term); 10 mg/L (short-term)

Source: (MPCA, 2015c)

#### **REGULATIONS & PERMITTING**

Currently, the State of Minnesota does not have a state-specific code applicable to stormwater harvesting and use. In 2011, the Council developed the Stormwater Reuse Guide<sup>12</sup>, to aid cities, engineers, and homeowners in planning and evaluating stormwater harvesting and use projects. Several different agencies will likely need to permit any project implemented. A summary of potentially applicable permits is summarized in Table 43.

<sup>12</sup> <http://www.metrocouncil.org/Wastewater-Water/Planning/Water-Supply-Planning.aspx>

**Table 43. Summary of Potential Permitting Requirements for Stormwater Use Projects**

Agency/Regulatory Authority	Summary of Requirements
Municipal permit (by City)	Any stormwater use project implemented may require permits from the city in which are located. Municipal permits may be zoning permits, conditional use permits, municipal storm drain connection permits, and municipal construction permits. The Minnesota Plumbing Code has additional requirements and standards that may include uses, construction materials, and professional standards for plumbers installing systems.
U.S. Army Corps of Engineers	Section 404 of the Clean Water Act regulates the discharge of dredged and/or fill material in waters of the U.S. Under Section 10 of the Rivers and Harbors Act of 1899, the USACE regulates work in navigable waters of the U.S. Section 401 of the Clean Water Act requires any applicant for a Section 404 permit to obtain Water Quality Certification from the State to certify that discharge from fill materials will be in compliance with the State's applicable Water Quality Standards.
MPCA Erosion Control Permit (NPDES)	Any project that disturbs more than 1 acre of soil or discharges to a special or impaired water is required to apply for a NPDES permit. Additionally, any use of stormwater for construction-related activities, such as dust control, must comply with stormwater management requirements contained in the Stormwater Pollution Prevention Plan (SWPPP).
Public Drainage Systems	Any time a public drainage system is created, repaired, improved, extended, abandoned, transferred to another drainage system, or water is impounded or ponded, a petition must be filed for the project, as described by Minnesota Statute 103E. The drainage system may be under the jurisdiction of one of several drainage authorities. The most common are county boards of commissioners, a joint county drainage authority, or a watershed district board of managers. When a drainage system is located within an organized Watershed District, it becomes the drainage authority for the project. Within the Twin Cities seven-county metro area, local governments outside of organized Watershed Districts are required to participate in a Watershed Management Organization (WMO), per Minnesota Statutes 103B.201 to 103B.255. WMOs are required to manage surface water. When a drainage system is not located within a Watershed District, WMO, or municipality, the county board of commissioners or joint county drainage authority has jurisdiction over the drainage project. <sup>13</sup>
MnDNR Groundwater Appropriations Permits	Use of any water of the state (surface water or groundwater) requires an appropriation permit if the withdrawal exceeds 10,000 gallons per day or 1 million gallons per year. If stormwater use will exceed these thresholds, then an appropriation permit will be required. In addition, if a supplemental source of water is needed to provide additional supply during periods of low rainfall or excessive irrigation or other use, a groundwater or surface water appropriation permit would be required if minimum thresholds are met.
Minnesota Department of Health (MDH) / County Health Department	If the use of the harvested stormwater has the potential for human exposure, the MDH should be contacted to ensure the use will not cause a public health nuisance. MDH will need to grant approval for this use of the stormwater.
Metropolitan Council Environmental Services (MCES) Industrial Waste Discharge Permit	Industrial users discharging into public sewers shall apply for an industrial discharge permit, unless MCES determines that the wastewater has an insignificant impact on public sewers. If the use of stormwater is classified as industrial, including the use of the stormwater in vehicle maintenance activities, a MCES Industrial Discharge Permit is required.

<sup>13</sup> Within the study area, the following Watershed Districts or Watershed Management Organizations have jurisdictional authority over public drainage projects, in order of largest percentage of the study area, and should be contacted for permitting requirements in the project planning process: Vermillion River Watershed Joint Powers Organization, Lower Mississippi River WMO, Eagan-Inver Grove Heights WMO, Black Dog WMO, Lower Minnesota River Watershed District, Credit River WMO.

Agency/Regulatory Authority	Summary of Requirements
MPCA and MCES Sanitary Sewer Extension Permit	If any modifications are made to existing public sanitary sewers as a part of a stormwater use project, a Sanitary Sewer Extension Permit will be required from the MPCA and MCES.
Minnesota Department of Agriculture	If the use of the stormwater is meant for commercial operations, including nurseries and grain, vegetable, or fruit producers, the Minnesota Department of Agriculture may need to permit the project.

### STORMWATER CAPTURE AND REUSE IMPLEMENTATION COSTS

Costs associated with stormwater capture and reuse systems for irrigation can vary greatly depending on a number of factors including the application or intended use, proximity to conveyance, storage requirements and design, site conditions and constraints, treatment and pumping costs, and the need for landscaping and other features.

For this study, conceptual costs for stormwater capture and reuse systems were tabulated for a range of storage volumes and include both underground storage and pond storage systems suitable for urban irrigation applications. These costs are summarized in Table 44. Capital costs include conveyance, treatment, storage and pumping components as well as engineering, administration, and contingencies. Costs do not include land acquisition, as these vary greatly depending on location, or the cost for irrigation systems. Approximate requirements for land area for each system size are listed. More information on the basis for these costs can be found in Appendix A3.

**Table 44. Conceptual Cost for Stormwater Capture and Reuse Systems**

Storage Volume (gallons)	Stormwater Capture Pond Systems		Underground Storage System		Capital Cost per Gallon Storage (\$/1,000 gallon)
	Capital Cost <sup>1</sup> (\$ x 1,000)	Land Area Required (acres)	Capital Cost <sup>1</sup> (\$ x 1,000)	Land Area Required (acres)	
10,000	-	-	\$25 - \$100	0.01 – 0.05	\$2.5 - \$10
50,000	\$50 - \$100	0.35 – 0.5	\$125 - \$250	0.05 – 0.1	\$1 - \$5
150,000	\$80 - \$160	0.5 – 0.75	\$200 - \$400	0.15 – 0.25	\$0.50 - \$2.70
250,000	\$100 - \$200	0.75 – 1	\$300 - \$600	0.2 – 0.5	\$0.40 - \$2.40
500,000	\$150 - \$275	1 – 1.5	\$500 - \$1,500	0.55 – 0.75	\$0.30 - \$3.00
1,000,000	\$275 - \$450	1.75 – 2.25	-	-	\$0.28 - \$0.45

Notes:

<sup>1</sup> Costs include construction costs, contingency (30%), and engineering, permitting, and administration costs (20%). Costs do not include land acquisition or landscaping improvements other than site restoration.

Costs will vary depending on a number of considerations, including:

- Local site conditions;
- Type and final design of storage;
- Proximity of source water, conveyance and pumping needs;
- Treatment requirements;
- Land or property acquisition costs; and
- Regulatory and permitting requirements.

For small stormwater reuse projects that require less than 10,000 gallons of storage, it is typically more feasible to store stormwater for reuse in a manufactured tank rather than constructing a pond. For larger stormwater reuse projects requiring more than 50,000 gallons of storage, it is typically more economical to construct a stormwater pond than it is to build an underground storage system. However, depending on zoning requirements or the need or desire to maintain open space, construction of a large underground system may be more appealing than construction of a stormwater pond or above ground system. When possible, modifying an existing stormwater pond rather than constructing a new pond for storage can result in a cost savings.

Operations and maintenance costs were not included in these cost estimates, but should be considered when evaluating the type of system for implementation. Typically, stormwater reuse systems will require regular operation and maintenance of the equipment and system components including:

- Regular inspection and testing of valves and all operational structures;
- Monthly inspection of biofilm and for accumulation of sediment in filters;
- Annually testing of control equipment at spring start-up, or as recommended by manufacturer;
- Settings to control the timing of operations if systems must limit human exposure for untreated or minimally treated stormwater;
- An annual winterization schedule for draining pumping and distribution systems required to take the system off-line; and
- An O&M plan, including a detailed site plan that shows the locations of the distribution system, potable connection, backflow prevention devices, valves and types of valves, drain plug, and cleanout sump.

### **Examples of Local Stormwater Capture and Use Systems**

While stormwater reuse facilities are still a relatively new concept in Minnesota, several projects have been constructed and provide good examples for others in the state. These include:

**St. Anthony Village Water Reuse Facility.** The facility collects stormwater from 15.4 acres of land and filter backwash water from the city's water treatment plant. The runoff and backwash water is stored in a 500,000 gallon underground reservoir. Water from the reservoir is used to irrigate a 20-acre site including a municipal park and St. Anthony's City Hall campus. Total reported costs for this project were \$1.5 million (University of Minnesota Extension, 2013).



**Oneka Ridge Golf Course.** This project was recently constructed in Hugo, Minnesota to collect stormwater runoff from 1,000 acres of land upstream of Bald Eagle Lake to irrigate the 116-acre golf course. Stormwater is collected in a new stormwater pond. The project is expected to capture approximately 32.5 million gallons of water per year for irrigation and underground infiltration, while the water volume of Bald Eagle Lake, downstream of the project, is estimated to decrease by only 0.3 percent. The total reported cost for this project was just under \$700,000 (Rice Creek Watershed District, 2015).

**Shakopee Mdewakanton Sioux Reuse System.** This system in Prior Lake, Minnesota collects stormwater runoff from a 390-acre drainage area and effluent from a 0.5 MGD wastewater treatment plant and provides irrigation water for the 120-acre Meadows at Mystic Lake Golf Course. The golf course aims to reduce their annual groundwater demand for irrigation use of 52 million gallons per year through the 5.5 million gallons of stormwater runoff per year and the 0.5 MGD WWTP effluent (Bolton and Menk, 2009).

## **Wastewater Reuse**

Metropolitan Council Environmental Services conducted a preliminary study of wastewater reuse in a sub-region of the Southeast Metro Study Area including an assessment of potential reclaimed water demands and costs for potential systems in the Empire wastewater treatment plant service area. The study focused on Apple Valley, Farmington, Lakeville and Rosemount because of their proximity to the Empire plant.

A copy of the MCES memorandum is included in Appendix A10.

## **Regional Implementation Planning**

As part of the Regional Feasibility Assessment project HDR provided assistance to the Council with the identification of cost-sharing or financing structures that would promote financial equity within shared or semi-regional systems in the Twin Cities Metropolitan Area. HDR summarized the institutional and financial structures or considerations associated with cost-sharing approaches identified from three examples of regional water system cost sharing arrangements in a technical memorandum. In determining the three case studies, HDR looked for systems where the dependence on groundwater needed to be reduced and where cost-sharing was occurring among various entities of varying sizes. Two systems with similar cost-sharing and financial approaches were identified in Texas. These include the San Jacinto River Authority – Groundwater Reduction Program Division and the West Harris County Regional Water Authority. The third example is the Woodlands-Davis Clean Water Agency in California.

A copy of the draft technical memorandum is included in Appendix A11.

## Glossary

<b>Aquifer</b>	Rock or sediment that is saturated and able to transmit economic quantities of water to wells and surface waters. Minnesota Administrative Rules 6115.0630 defines aquifer as any water-bearing bed or stratum of earth or rock capable of yielding groundwater in sufficient quantities that can be extracted.
<b>Digital Elevation Model (DEM)</b>	A digital model of a terrain's surface, constructed from surface elevation data generally acquired by airplane or satellites using remote-sensing techniques such as photogrammetry and LiDAR, or by land surveying.
<b>Drawdown</b>	The lowering of the water table in and around a pumping well. It is the difference between the pumping water level and the original water level.
<b>Drinking Water Supply Management Area</b>	A drinking water supply management area (DWSMA) is the Minnesota Department of Health approved surface and subsurface area surrounding a public water supply well that completely contains the scientifically calculated wellhead protection area and is managed by the entity identified in a wellhead protection plan. The boundaries of the drinking water supply management area are delineated by identifiable physical features, landmarks or political and administrative boundaries.
<b>Enhanced Recharge</b>	Manmade infiltration of surface water into the zone of saturation, with the express purpose of hastening recharge of an aquifer(s).
<b>Groundwater</b>	Water stored in the pore spaces of rock and unconsolidated deposits found in the saturated zone of an aquifer (compare to surface water). Minnesota Administrative Rules 6115.0630 defines groundwater as subsurface water in the saturated zone. The saturated zone may contain water under atmospheric pressure (water table condition), or greater than atmospheric pressure (artesian condition).
<b>Hydraulic Conductivity</b>	A measure of the permeability of the porous media. It is commonly measured in feet per day (ft/day).
<b>Infiltration</b>	<ol style="list-style-type: none"> <li>1. The seepage of water from land surface down below the root zone. This water may move horizontally through the soil toward nearby streams, wetlands, and lakes – becoming baseflow. Or this water may move vertically down to recharge deeper regional aquifers.</li> <li>2. The seepage of groundwater into sewer pipes through cracks or joints in the pipes.</li> </ol>
<b>Infrastructure</b>	Fixed facilities, such as sewer lines and roadways; permanent structures.

<b>Metro Model</b>	The Twin Cities metropolitan area regional groundwater flow model. The current modeling effort builds upon the Minnesota Pollution Control Agency's 2000 Metro Model. The current Metro Model (version 3) is used to evaluate the groundwater impacts of current and projected groundwater withdrawals. Information provided by the Metro Model helps set regional goals, screen for future risks, and evaluate/compare the regional impact of different water supply approaches.
<b>Non-winter Runoff</b>	The rainfall, snowmelt, or irrigation water flowing that has not evaporated or infiltrated into the soil, but flows over the ground surface during the period of March 15 through November 31.
<b>Non-potable User</b>	A public or private entity that obtains treated municipal water for uses other than human consumption.
<b>Open Space</b>	Public and private land that is generally natural in character. It may support agricultural production, or provide outdoor recreational opportunities, or protect cultural and natural resources. It contains relatively few buildings or other human-made structures. Depending on the location and surrounding land use, open space can range in size from a small city plaza or neighborhood park of several hundred square feet, corridors linking neighborhoods of several acres to pasture, croplands or natural areas and parks covering thousands of acres.
<b>Recharge</b>	<ol style="list-style-type: none"> <li>1. The natural or manmade infiltration of surface water into the zone of saturation. Also, the portion of infiltration that moves from the unsaturated sediment below the root zone into the underlying zone of saturation. (See also enhanced recharge.</li> <li>2. The movement of groundwater into a surface water body such as a stream or lake.</li> </ol>
<b>Reuse</b>	The collection and use of water that is reclaimed for specific, direct, and beneficial uses. The term is also used to describe water that is collected on-site and utilized in a new application. (See also stormwater reuse.)
<b>Runoff</b>	The rainfall, snowmelt, or irrigation water flowing that has not evaporated or infiltrated into the soil, but flows over the ground surface.
<b>Run-on</b>	The rainfall, snowmelt, or irrigation water flowing over the ground surface (i.e., runoff) that is received at a specific downstream point or location.
<b>Special Well and Boring Construction Area</b>	<p>A Special Well and Boring Construction Area is sometimes also called a well advisory. It is a mechanism which provides for controls on the drilling or alteration of public and private water supply wells, and monitoring wells in an area where groundwater contamination has, or may, result in risks to the public health.</p> <p>The purposes of a Special Well and Boring Construction Area are to inform the public of potential health risks in areas of groundwater contamination, provide for the construction of safe water supplies, and prevent the spread of contamination due to the improper drilling of wells or borings.</p>

<b>Stormwater</b>	Surplus surface water generated by rainfall that does not seep into the earth but flows overland to flowing or stagnant bodies of water. (See also runoff.) Minnesota Department of Natural Resources defines stormwater more specifically as runoff from impervious surfaces.
<b>Stormwater Reuse</b>	The collection and use of stormwater runoff that is reclaimed for specific, direct, and beneficial uses. The term is also used to describe water that is collected on-site and utilized in a new application. It is also called rainwater harvesting, rainwater recycling, or rainwater reclamation. Minnesota Department of Natural Resources more specifically defines stormwater reuse as the secondary use of water for a purpose other than what it was originally appropriated for.
<b>Subwatershed</b>	A portion of a watershed that still meets the definition of a watershed in that all of the water that is under it or drains off of it goes into the same place.
<b>Surface Water</b>	Water on the earth's surface exposed to the atmosphere such as rivers, lakes and creeks (compare with groundwater).
<b>Treated Wastewater</b>	The effluent from a wastewater treatment plant after the wastewater has been treated. Treated wastewater that is discharged either to the surface or subsurface must meet the requirements of the National Pollutant Discharge Elimination System (NPDES)/State Disposal System (SDS) permit.
<b>Unsaturated Zone</b>	Area below the land surface that contains a mixture of air and water.
<b>Wastewater</b>	Water carrying waste from domestic, commercial, or industrial facilities together with other waters that may inadvertently enter the sewer system through infiltration and inflow.
<b>Wastewater Treatment Plant</b>	A facility designed for the collection, removal, treatment, and disposal of wastewater generated within a service area.
<b>Watershed</b>	The area of land where all of the water that is under it or drains off of it goes into the same place.
<b>Water Table</b>	The elevation at which the pore water pressure is at atmospheric pressure.

## Acronyms and Short Forms

acft	Acre-feet
acft/yr	Acre-feet per year
AMA	Aquatic Management Area
AMSL	Above mean sea level
AWHC	Available Water Holding Capacity
BWSR	Board of Water and Soil Resources
CFR	Code of Federal Regulations
cfs	Cubic feet per second
Council	Metropolitan Council
CWI	County Well Index
DEM	Digital Elevation Model
DWSMA	Drinking Water Supply Management Area
EPA	U.S. Environmental Protection Agency
ft/day	Feet per day
GIS	Geographic Information System
gpm	Gallons per minute
in/hr	Inches per hour
KMM	Kraemer Mining and Materials, Inc.
MCES	Metropolitan Council Environmental Services
MDA	Minnesota Department of Agriculture
MDH	Minnesota Department of Health
MG	Millions of U.S. gallons
MGD	Million gallons per day
mg/L	Milligrams per liter
MGS	Minnesota Geological Survey
mi <sup>2</sup>	Square mile
MIDS	Minimal impact design standards
MLCCS	Minnesota Land Cover Classification System
MnDNR	Minnesota Department of Natural Resources
MnDOT	Minnesota Department of Transportation
MOVE	Maintenance of Variance Extension
MPCA	Minnesota Pollution Control Agency
MS4	Municipal Separate Storm Sewer System
NED	National Elevation Dataset
NOAA	National Oceanic and Atmospheric Administration
NPC	Native Plant Communities

NPDES	National Pollutant Discharge Elimination System
NRCS	National Resource Conservation Service
NTU	Nephelometric Turbidity Unit
O&M	Operation and maintenance
PDSI	Palmer Drought Severity Index
PMDI	Modified Palmer Drought Index
Q <sub>90</sub>	90 <sup>th</sup> percentile Exceedance Flow Value
R <sup>2</sup>	Correlation coefficient
RNRA	Regional Natural Resource Area
SDS	State Disposal System
SNA	Scientific and Natural Area
SPI	Standard Precipitation Index
SWBCA	Special Well and Boring Construction Area
SWUDS	State Water Use Database System
TDS	Total dissolved solids
T&E	Threatened and Endangered (species)
TSS	Total suspended solids
TWDB	Texas Water Development Board
UIC	Underground Injection Control
USACE	U.S. Army Corps of Engineers
USDA	U.S. Department of Agriculture
USGS	U.S. Geological Survey
VIC	Voluntary Investigation and Cleanup
WDCWA	Woodland-Davis Clean Water Agency
WECP	Water Emergency and Conservation Plan
WHPA	Wellhead Protection Area
WMA	Wildlife Management Area
WMO	Water Management Organization
WWTP	Wastewater treatment plant

## References

- Barr Engineering. 2010. Evaluation of groundwater and surface-water interaction: guidance for resource assessment, Twin Cities Metropolitan Area, Minnesota: Prepared for Metropolitan Council, June 2010. 27p. plus GIS files.
- Bolton and Menk, Inc. 2009. *City Engineers Association of Minnesota. CEAM Annual Conference*. <http://ceam.org/vertical/Sites/%7BD96B0887-4D81-47D5-AA86-9D2FB8BC0796%7D/uploads/%7BA01ADDBD-B953-4CBC-9AE9-359B260657A5%7D.PDF>. Website accessed April 30, 2015
- Changnon, S. 1987. "Detecting Drought Conditions in Illinois", Illinois State Water Survey.
- EPA Guidance Manual, Alternative Disinfectants and Oxidants, EPA 815-R-99-014, pp. 6-24 to 6-27.
- Fairbairn, D. 2011. Minnesota Water Supply and Availability. University of Minnesota Water Resources Center.
- Grigg, N. 1996. "Water Resources Management: Principles, Regulations, and Cases".
- Hayes, M. 2002. "Drought Indices", National Drought Mitigation Center. June.
- Hirsch, Robert. 1982. "A Comparison of Four Streamflow Record Extension Techniques". *Water Resources Research*, Vol. 18, Number 4.
- Homer, C., Dewitz, J., Fry, J., Coan, M., Hossain, N., Larson, C., Herold, N., McKerrow, A., VanDriel, J.N., and Wickham, J. 2007. Completion of the 2001 National Land Cover Database for the Conterminous United States. *Photogrammetric Engineering and Remote Sensing*, Vol. 73, No. 4, pp 337-341.
- McKee, T. et al. 1993. "The Relationship of Drought Frequency and Duration to Time Scales.", Eighth Conference on Applied Climatology.
- McPherson, L. 2014. *Taking the Rains: Examining Stormwater Collection and Treatment Methods for Reuse*. WaterWorld.
- Metropolitan Council, 2010. Metropolitan Area Master Water Supply Plan.
- Metropolitan Council. 2015. *Twin Cities Metropolitan Area Master Water Supply Plan*. Metropolitan Council: St. Paul, MN.
- Metropolitan Council, 2014. Twin Cities Metropolitan Area Regional Groundwater Flow Model, Version 3.0. Prepared by Barr Engineering. Metropolitan Council: Saint Paul, MN.
- Metropolitan Council Environmental Services. 2009. Twin Cities Metropolitan Area Regional Groundwater Flow Model, Version 2.00 (Metro Model 2) Projected Aquifer Drawdown DEMs – Twin Cities Metropolitan Area, FTP server, GIS file download, <ftp://gisftp.metc.state.mn.us/GroundwaterModelResults.zip>. Website accessed June 6, 2014.



Metropolitan Council Environmental Services. 2011. FTP server, GIS file download, <ftp://gisftp.metc.state.mn.us/>. Website accessed September 2011.

Metropolitan Council Environmental Services. 2014. Regional Planned Land Use – Twin Cities Metropolitan Area, GIS file download, <http://www.datafinder.org/metadata/PlannedLandUse.html>. Website accessed March 12, 2014.

Minnesota Department of Agriculture. 2014. What's in my neighborhood? Agricultural interactive mapping, GIS file download <http://www.mda.state.mn.us/chemicals/spills/incidentresponse/neighborhood.aspx>. Website accessed May 8, 2014.

Minnesota Department of Health. 2007. Evaluating proposed stormwater infiltration projects in vulnerable wellhead protection areas, July.

Minnesota Department of Health. 2014a. Source water protection maps and geospatial data, GIS file download, <http://www.health.state.mn.us/divs/eh/water/swp/maps/>. Website accessed March 19, 2014.

Minnesota Department of Health. 2014b. Hastings groundwater capture zone GIS file. Email attachment from Amal Djerrari, May 13, 2014.

Minnesota Department of Natural Resources Division of Waters. 1989. Drought of 1988.

Minnesota Department of Natural Resources. 2000. Minnesota's Water Supply: Natural Conditions and Human Impacts.

Minnesota Department of Natural Resources. March 2004. System-Wide Low-Flow Management Plan Mississippi River above St. Paul, Minnesota.

Minnesota Department of Natural Resources Division of Waters. July 2006. Drought Response Plan.

Minnesota Department of Natural Resources Division of Ecological and Water Resources. 2012. Guidelines for Suspension of Surface Water Appropriation Permits. January.

Minnesota Department of Natural Resources. 2014a. The DNR data deli, GIS file download, <http://deli.dnr.state.mn.us/>. Website accessed April 9, 2014.

Minnesota Department of Natural Resources. 2014b. Water use – water appropriations permit program, GIS file download, [http://www.dnr.state.mn.us/waters/watermgmt\\_section/appropriations/wateruse.html](http://www.dnr.state.mn.us/waters/watermgmt_section/appropriations/wateruse.html). Website accessed April 24, 2014.

Minnesota Pollution Control Agency. 2014a. Spatial data, What's in my neighborhood (WIMN), GIS file download, <http://www.pca.state.mn.us/index.php/data/spatial-data.html>. Website accessed March 20, 2014.

- Minnesota Pollution Control Agency (MPCA). 2014b. *Stormwater program*. <http://www.pca.state.mn.us/index.php/water/water-types-and-programs/stormwater/index.html>. Website accessed November 5, 2014.
- Minnesota Pollution Control Agency (MPCA). 2015a. *Minimal impact design standards*. <http://www.pca.state.mn.us/index.php/water/water-types-and-programs/stormwater/stormwater-minimal-impact-design-standards-mids.html>. Website accessed September 22, 2015.
- Minnesota Pollution Control Agency (MPCA). 2015b. *Design criteria for infiltration basin*. Minnesota Stormwater Manual: [http://stormwater.pca.state.mn.us/index.php/Design\\_criteria\\_for\\_Infiltration\\_basin](http://stormwater.pca.state.mn.us/index.php/Design_criteria_for_Infiltration_basin). Website accessed December 24, 2015.
- Mossler, J.H. 2013. Bedrock geology of the Twin Cities ten-county metropolitan area, Minnesota. M-194 miscellaneous map series. Minnesota Geological Survey. GIS file download, <http://hdl.handle.net/11299/154925>. Website accessed March 28, 2014.
- National Environmental Satellite, Data, and Information Service (NESDIS). 2007. "Time Bias Corrected Divisional Temperature-Precipitation-Drought Index (TD-9640)".
- Palmer, W. 1965. "Meterological Drought", U.S. Weather Bureau Research Paper Number 45.
- Rice Creek Watershed District (RCWD). 2014. *Oneka Ridge Golf Course water re-use irrigation project*. Rice Creek Watershed District: [http://www.ricecreek.org/index.asp?SEC=31ABD821-A665-4BD3-BD8C-94D2358D5FE0&DE=F968FCD9-42ED-4D64-ABD5-B58EB8BF0715&Type=B\\_PR](http://www.ricecreek.org/index.asp?SEC=31ABD821-A665-4BD3-BD8C-94D2358D5FE0&DE=F968FCD9-42ED-4D64-ABD5-B58EB8BF0715&Type=B_PR). Website accessed April 15, 2015.
- Sterrett, Robert J. (Ed.). (2007). Groundwater and wells (3<sup>rd</sup> ed.). Bloomington, MN: Johnson Screens, a Weatherford Company.
- Tipping, R.G. 2011. Distribution of vertical recharge to upper bedrock aquifers, Twin Cities Metropolitan Area. Prepared for Metropolitan Council, November 9, 2011. 105 p. plus GIS files.
- University of Minnesota Extension. 2013. *Underground stormwater treatment & rain harvesting systems, stormwater reuse project examples*, <http://www.extension.umn.edu/environment/stormwater/components/Jan14pdfs/PHPProjectExamplesHDS01142013.pdf>.
- U.S. Army Corps of Engineers. 2004. Upper Mississippi River System Flow Frequency Study. Appendix B: St. Paul District Hydrology and Hydraulics Appendix.
- U.S. Army Corps of Engineers. 2011. Fargo-Moorhead Metropolitan Area Flood Risk Management: Supplemental Draft Feasibility Report and Environmental Impact Statement. Appendix A-1b: Expert opinion elicitation on impacts of increasing flood flows on the Fargo, ND-Moorhead, MN flood risk management project.
- U.S. Army Corps of Engineers. 2012. A History Tour: Upper Mississippi River Headwater Reservoirs Damsites.

U.S. Department of Agriculture, National Agricultural Statistics Service (NASS). Census of Agriculture (multiple years). Available on-line at:  
[http://www.nass.usda.gov/Data\\_and\\_Statistics/Quick\\_Stats/index.asp](http://www.nass.usda.gov/Data_and_Statistics/Quick_Stats/index.asp).

U.S. Department of Agriculture, Natural Resources Conservation Service (NRCS). 2014. Geospatial data gateway, GIS file download, <http://datagateway.nrcs.usda.gov/>. Website accessed April 10, 2014.

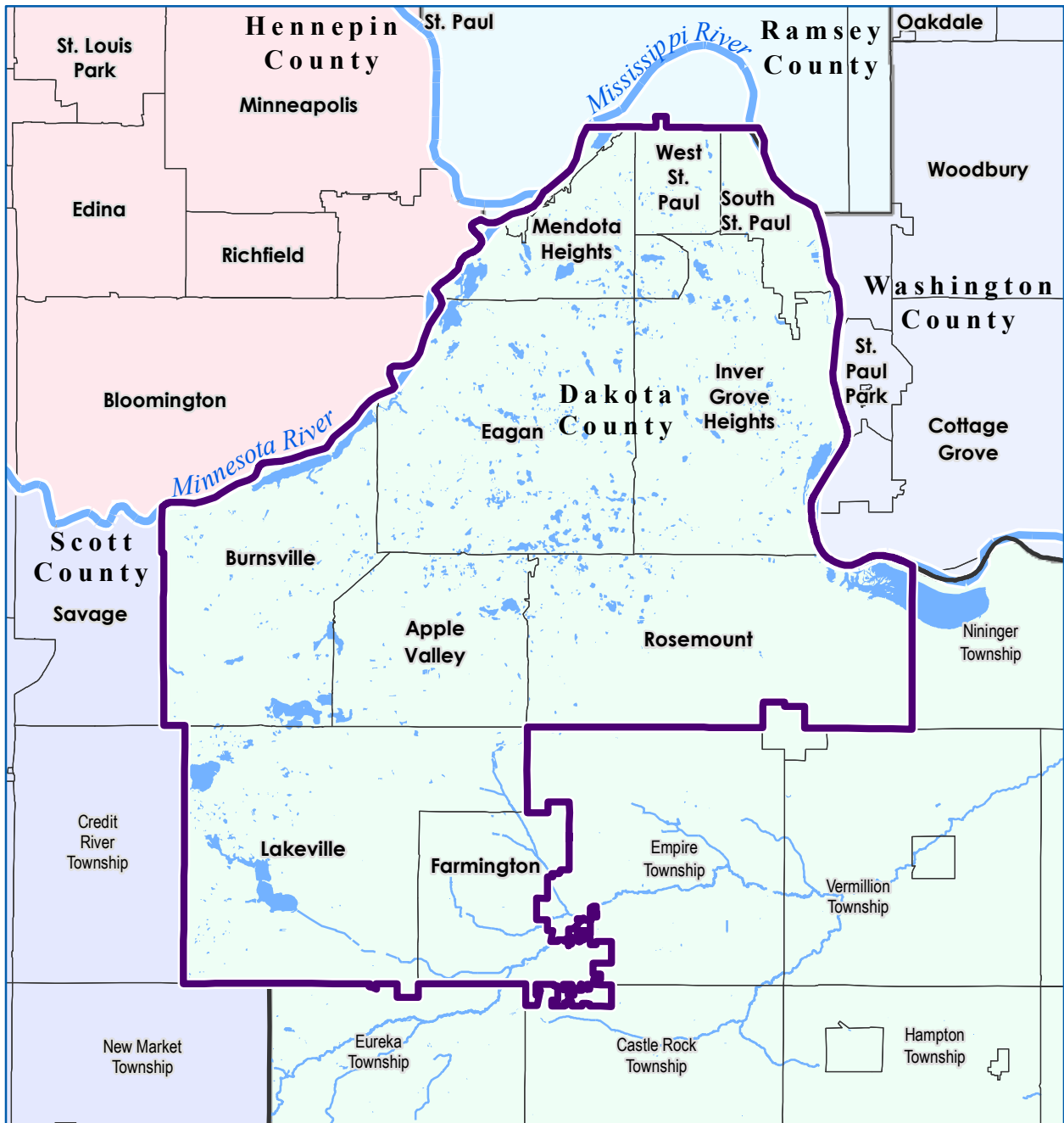
U.S. Department of Census, “Selected Historical Decennial Census Population and Housing Counts”, Available on-line at  
<http://www.census.gov/population/www/censusdata/hiscendata.html>.

United States Environmental Protection Agency, Office of Water, EPA Guidance Manual, Alternative Disinfectants and Oxidants, EPA 815-R-99-014.

U.S. Geological Survey. 2010. Low-Flow Characteristics of the Mississippi River Upstream from the Twin Cities Metropolitan Area, Minnesota, 1932–2007. Scientific Investigations Report 2010–5163.

United States Geologic Survey (USGS), 2015. *Water science glossary of terms*.  
<http://water.usgs.gov/edu/dictionary.html>. Website accessed on 12/28/15.

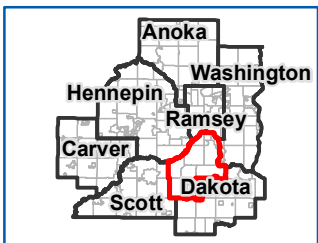
## Figures



**Legend**

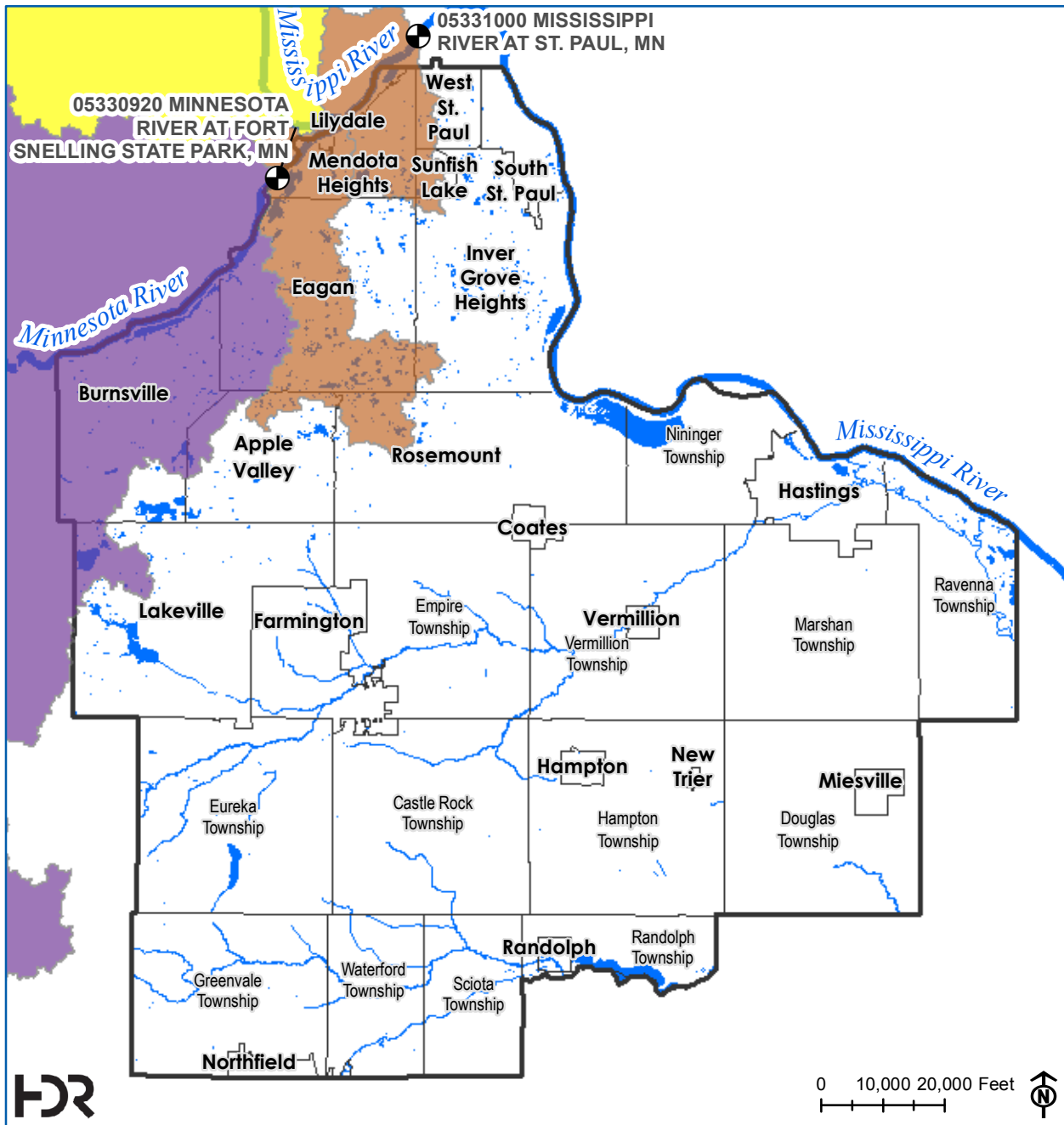
- Study Area
- County Boundary
- City/Township Boundary
- Perennial Stream
- Waterbody

0 20,000 Feet



Sources: Met Council, NHD, DNR

Document Path: \\mspe-gis-file\gisproj\MetCouncil\224209\map\_docs\Southeast\_Region\01\_StudyArea\_8x11P.mxd



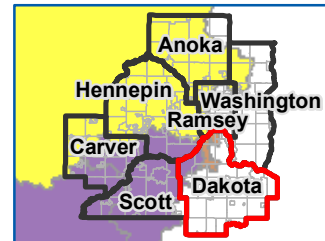
**Legend**

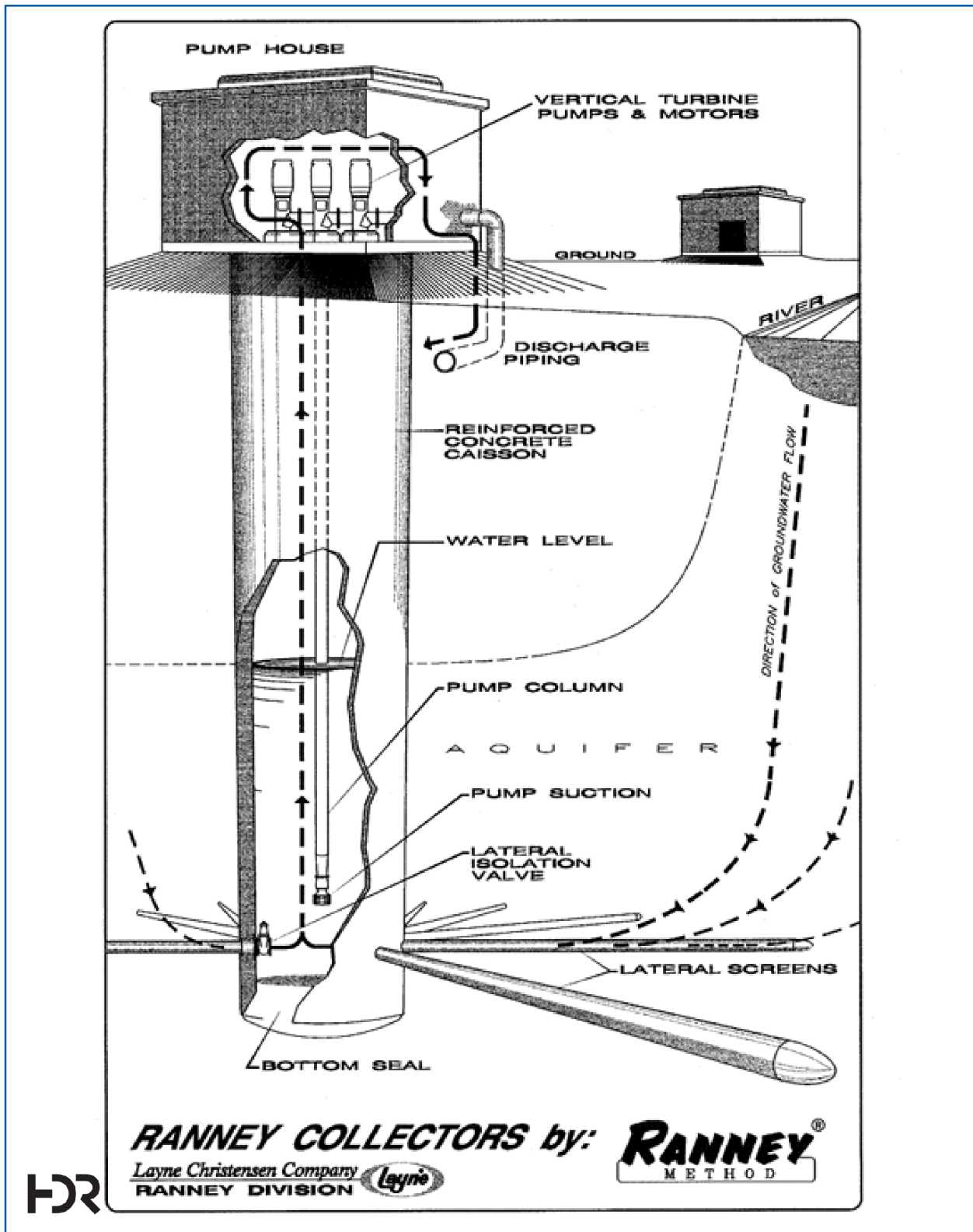
- County Boundary
- City/Township Boundary
- Perennial Stream
- Waterbody
- USGS Stream Gage

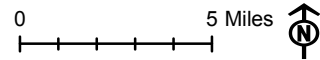
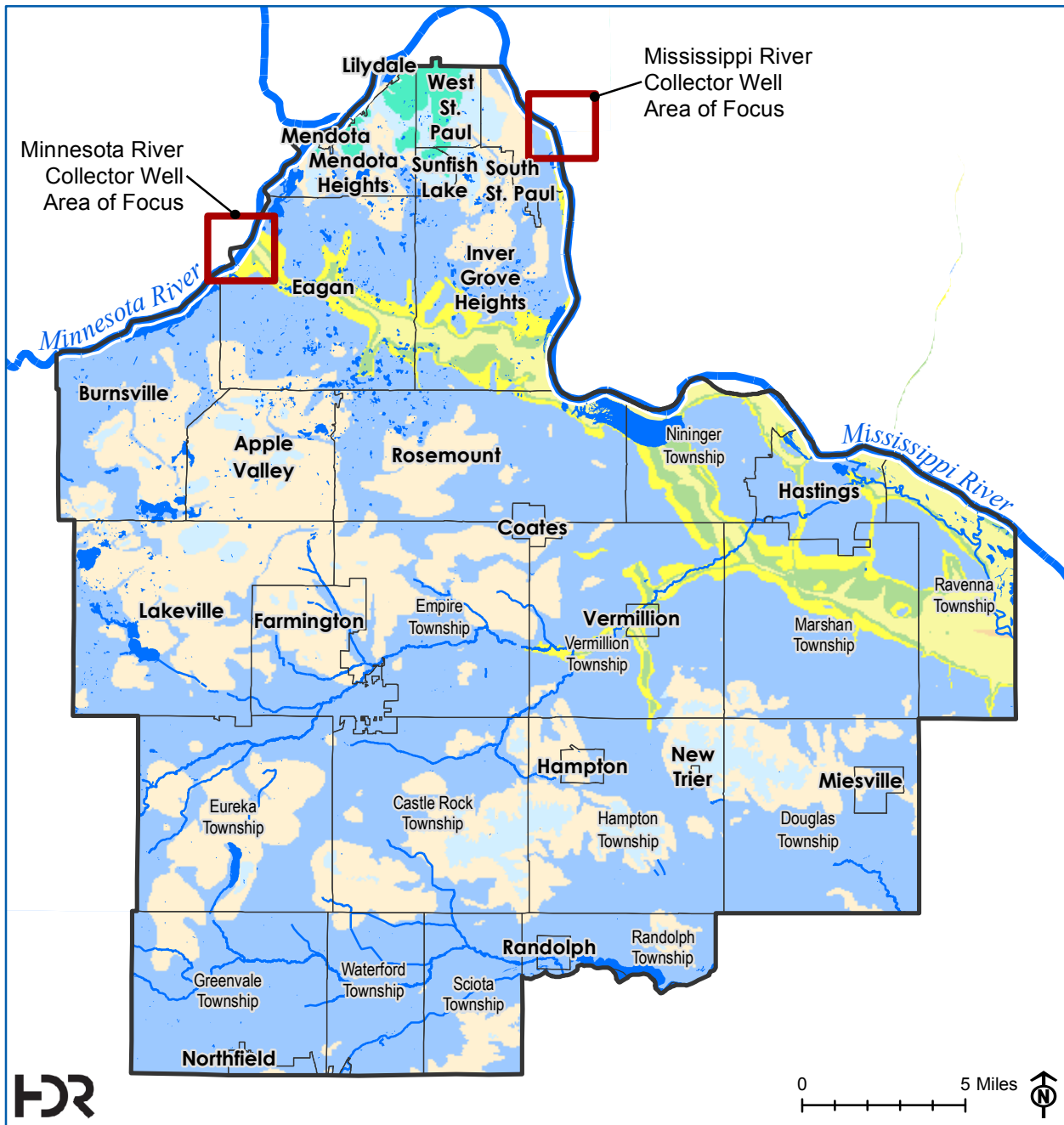
**Drainage Areas**

**Name**

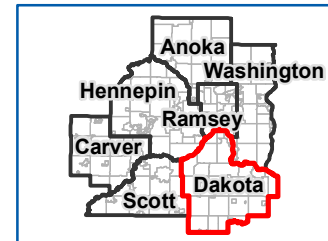
- Minnesota River Above Ft. Snelling State Park
- Mississippi River above Minnesota River
- Mississippi River below Minnesota River







Legend	
PALEOZOIC ROCKS	
Young	Decorah Shale, Galena Group
	Platteville and Glenwood Fms
	St. Peter Sandstone
	Prairie du Chien Group
	Jordan Sandstone
	St. Lawrence Formation
	Tunnel City Group
Old	Wonewoc Sandstone
	County Boundary
	City/Township Boundary
	Perennial Stream
	Waterbody



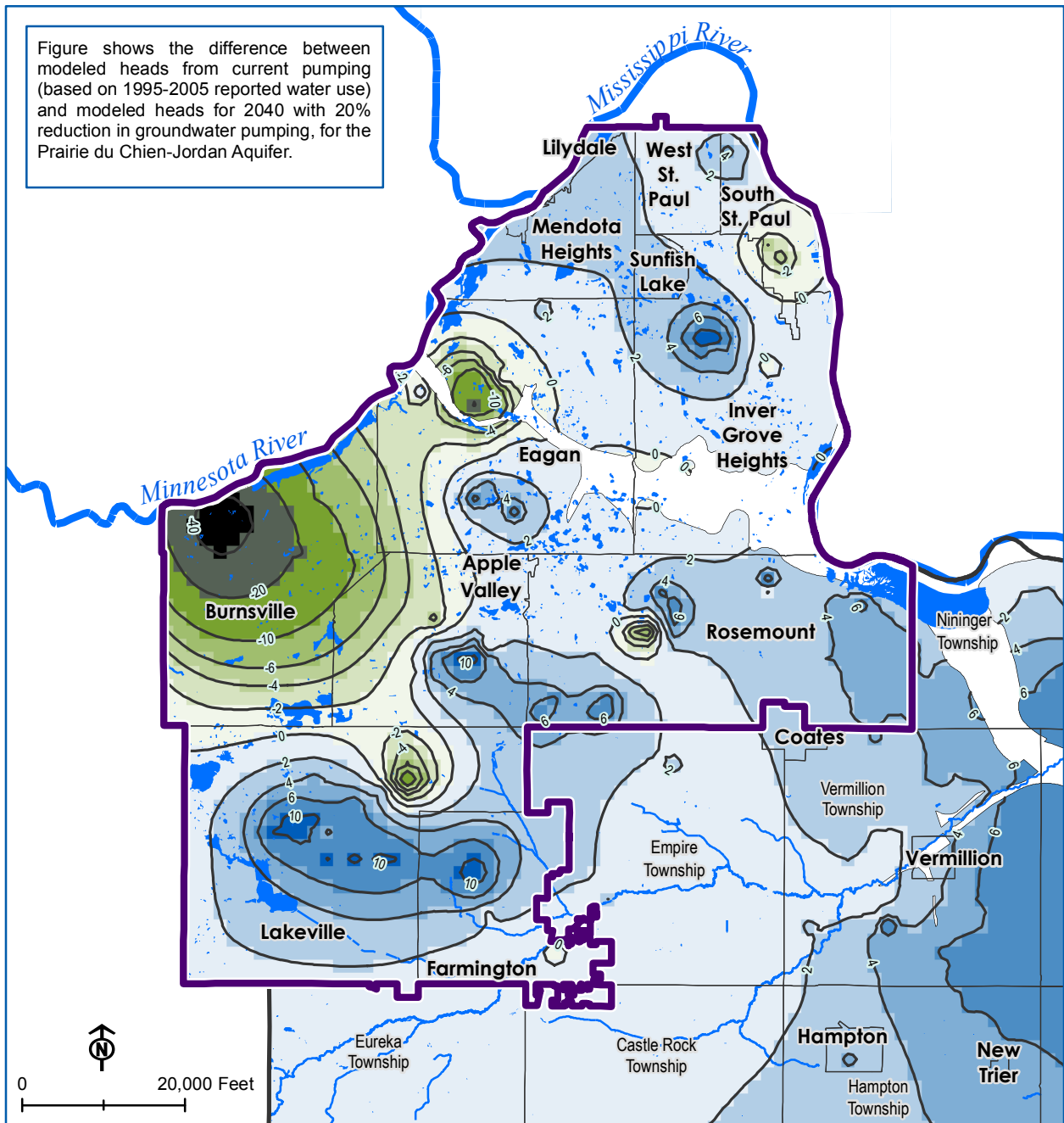
Sources: MGS

Document Path: \\mspe-gis-file\gisproj\MetCouncil\224209\map\_docs\Southeast\_Region\04\_CollectorWell\_8x11P.mxd




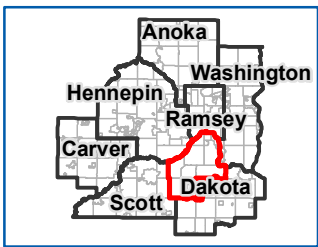


Figure shows the difference between modeled heads from current pumping (based on 1995-2005 reported water use) and modeled heads for 2040 with 20% reduction in groundwater pumping, for the Prairie du Chien-Jordan Aquifer.



**Legend**

Drawdown (ft)	Recovery (ft)	Symbol	Description
0 - 2	40+	—	Drawdown/Recovery Contour
2 - 4	20 - 40	□	Prairie du Chien and Jordan Absent
4 - 6	10 - 20	▭	Study Area
6 - 10	6 - 10	▭	County Boundary
10 - 20	4 - 6	▭	City/Township Boundary
20 - 40	2 - 4	—	Perennial Stream
40+	0 - 2	—	Waterbody

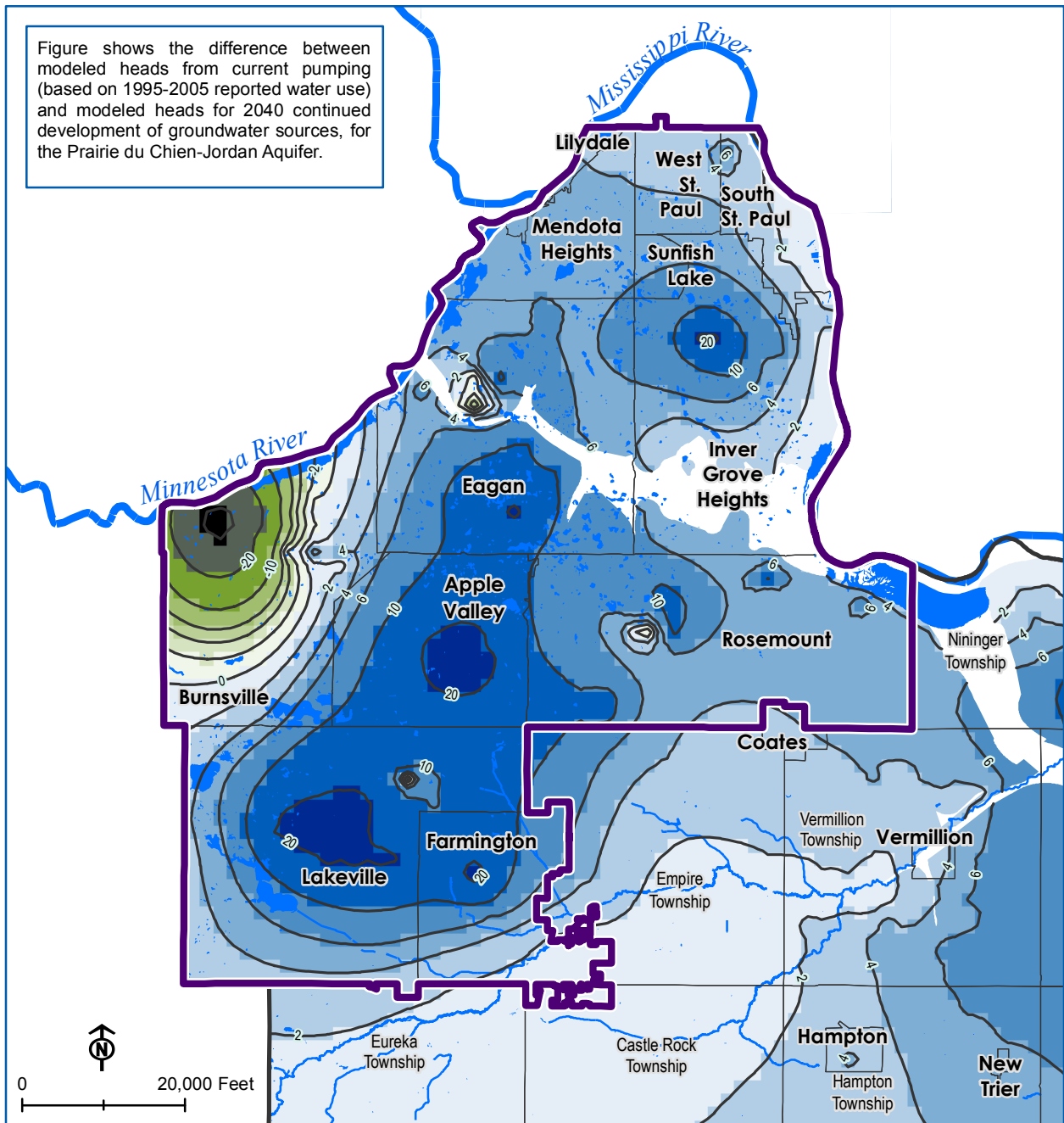



Sources: Met Council, NHD, DNR

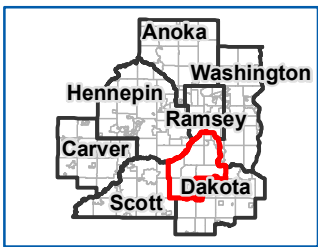
Document Path: \\mspe-gis-file\gisproj\MetCouncil\224209\map\_docs\Southeast\_Region\05\_20pct\_Reduction\_8x11P.mxd



Figure shows the difference between modeled heads from current pumping (based on 1995-2005 reported water use) and modeled heads for 2040 continued development of groundwater sources, for the Prairie du Chien-Jordan Aquifer.



Legend		
<b>Drawdown (ft)</b>	<b>Recovery (ft)</b>	— Drawdown/Recovery Contour
0 - 2	40+	□ Prairie du Chien and Jordan Absent
2 - 4	20 - 40	▭ Study Area
4 - 6	10 - 20	▭ County Boundary
6 - 10	6 - 10	▭ City/Township Boundary
10 - 20	4 - 6	— Perennial Stream
20 - 40	2 - 4	— Waterbody
40+	0 - 2	



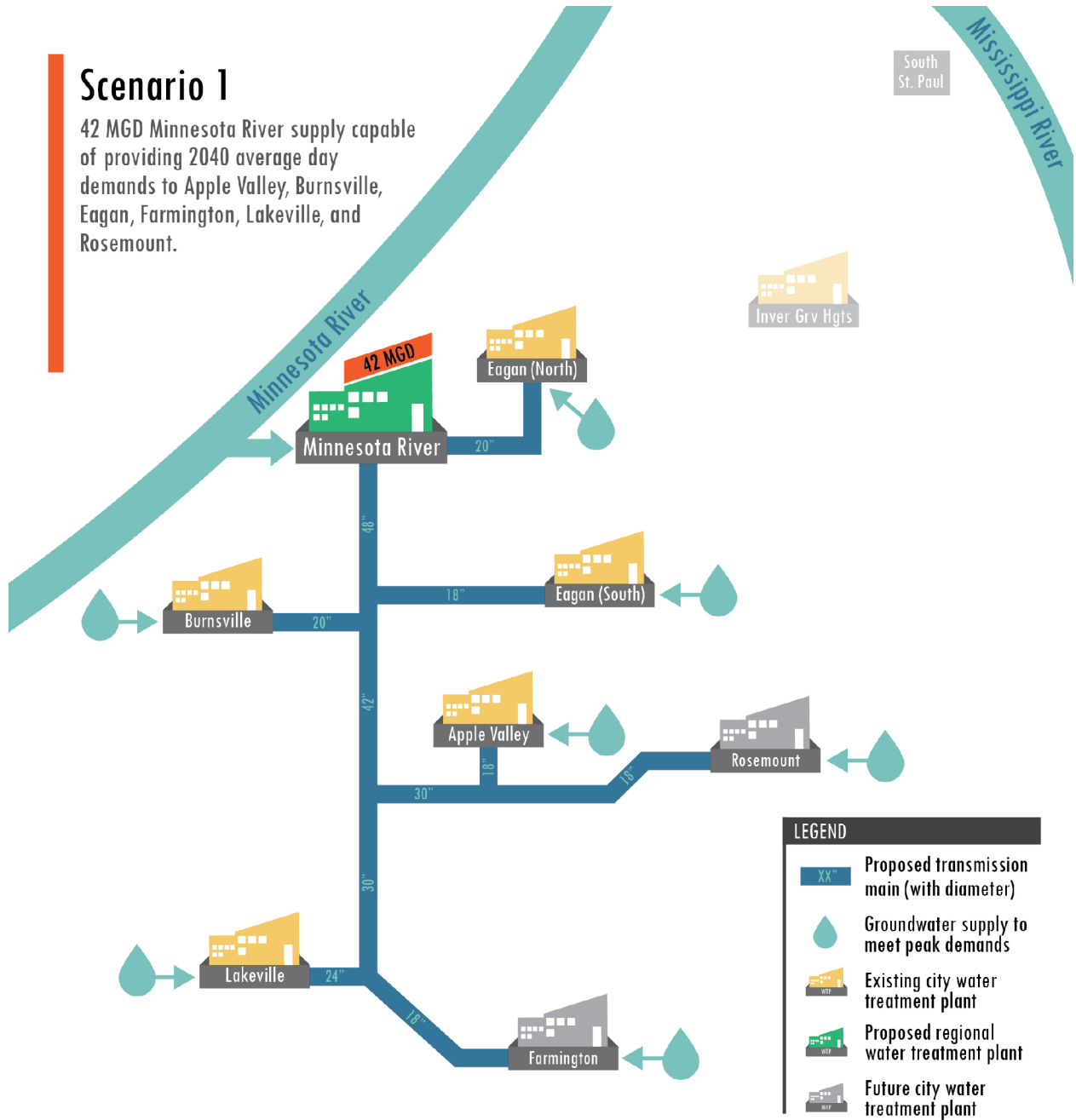
Sources: Met Council, NHD, DNR

Document Path: \\mspe-gis-file\gisproj\MetCouncil\224209\map\_docs\Southeast\_Region\06\_2040\_Drawdown\_8x11P.mxd



### Scenario 1

42 MGD Minnesota River supply capable of providing 2040 average day demands to Apple Valley, Burnsville, Eagan, Farmington, Lakeville, and Rosemount.

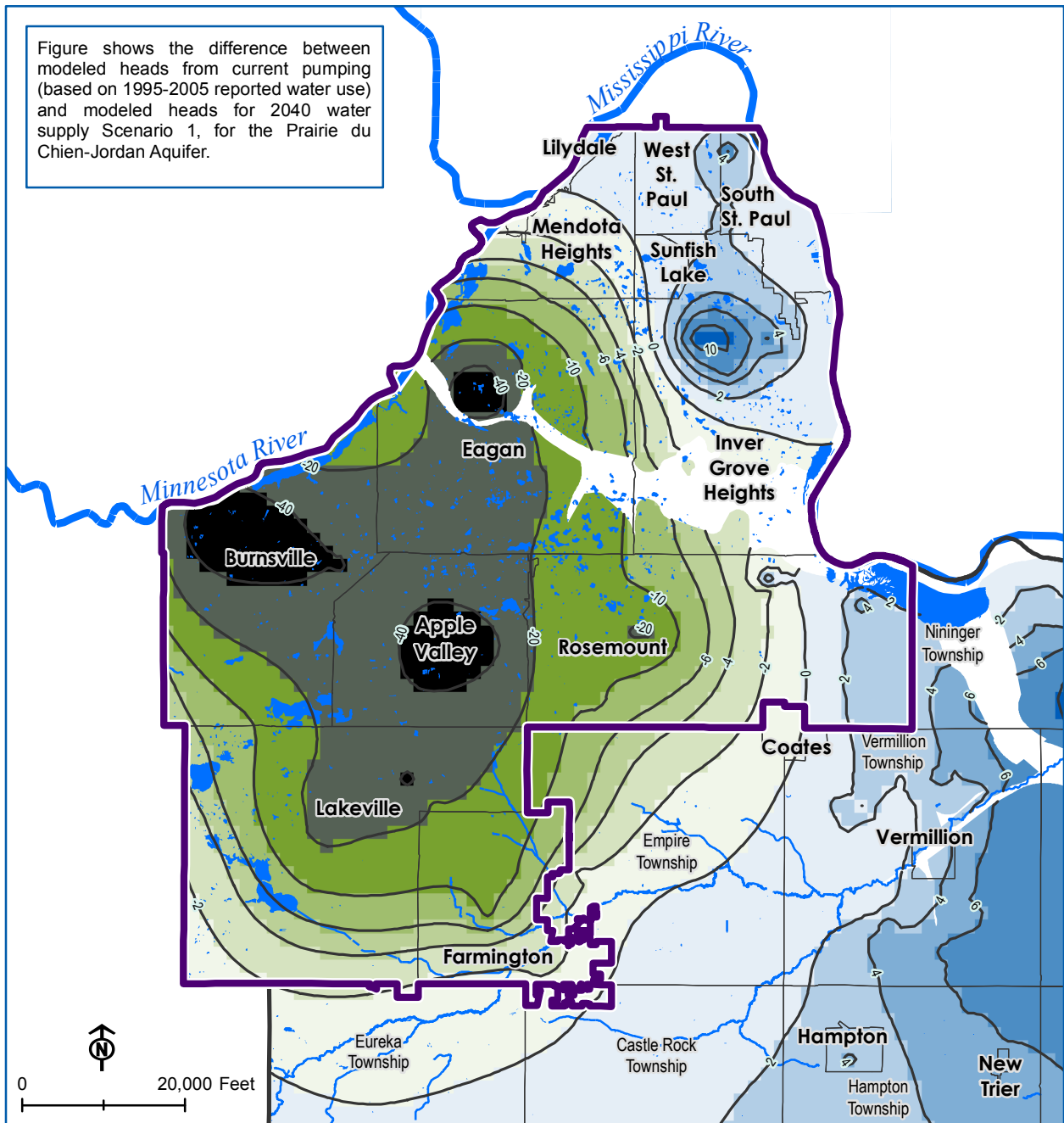


**LEGEND**

- XX" Proposed transmission main (with diameter)
- Water drop icon Groundwater supply to meet peak demands
- Yellow building icon Existing city water treatment plant
- Green building icon Proposed regional water treatment plant
- Grey building icon Future city water treatment plant

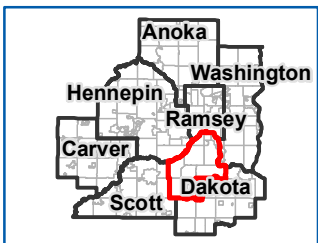


Figure shows the difference between modeled heads from current pumping (based on 1995-2005 reported water use) and modeled heads for 2040 water supply Scenario 1, for the Prairie du Chien-Jordan Aquifer.



Legend	
<b>Drawdown (ft)</b>	<b>Recovery (ft)</b>
0 - 2	40+
2 - 4	20 - 40
4 - 6	10 - 20
6 - 10	6 - 10
10 - 20	4 - 6
20 - 40	2 - 4
40+	0 - 2

- Drawdown/Recovery Contour
- Prairie du Chien and Jordan Absent
- ▭ Study Area
- ▭ County Boundary
- ▭ City/Township Boundary
- ~ Perennial Stream
- ☪ Waterbody



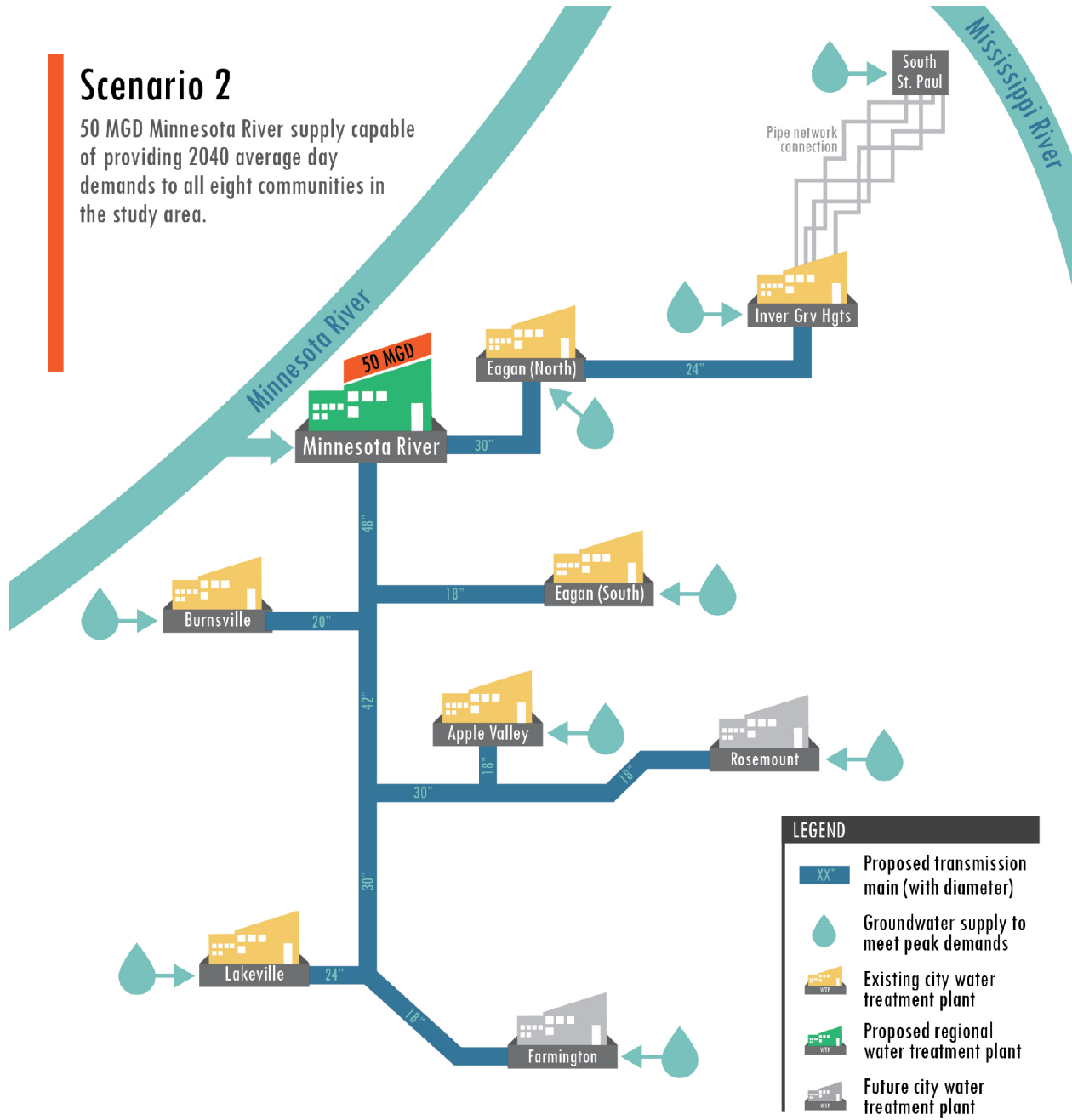
Sources: Met Council, NHD, DNR

Document Path: \\mspe-gis-file\gisproj\MetCouncil\224209\map\_docs\Southeast\_Region\08\_Scenario\_1\_8x11P.mxd



## Scenario 2

50 MGD Minnesota River supply capable of providing 2040 average day demands to all eight communities in the study area.



**LEGEND**

- XX" Proposed transmission main (with diameter)
- Teardrop icon Groundwater supply to meet peak demands
- Yellow building icon Existing city water treatment plant
- Green building icon Proposed regional water treatment plant
- Grey building icon Future city water treatment plant

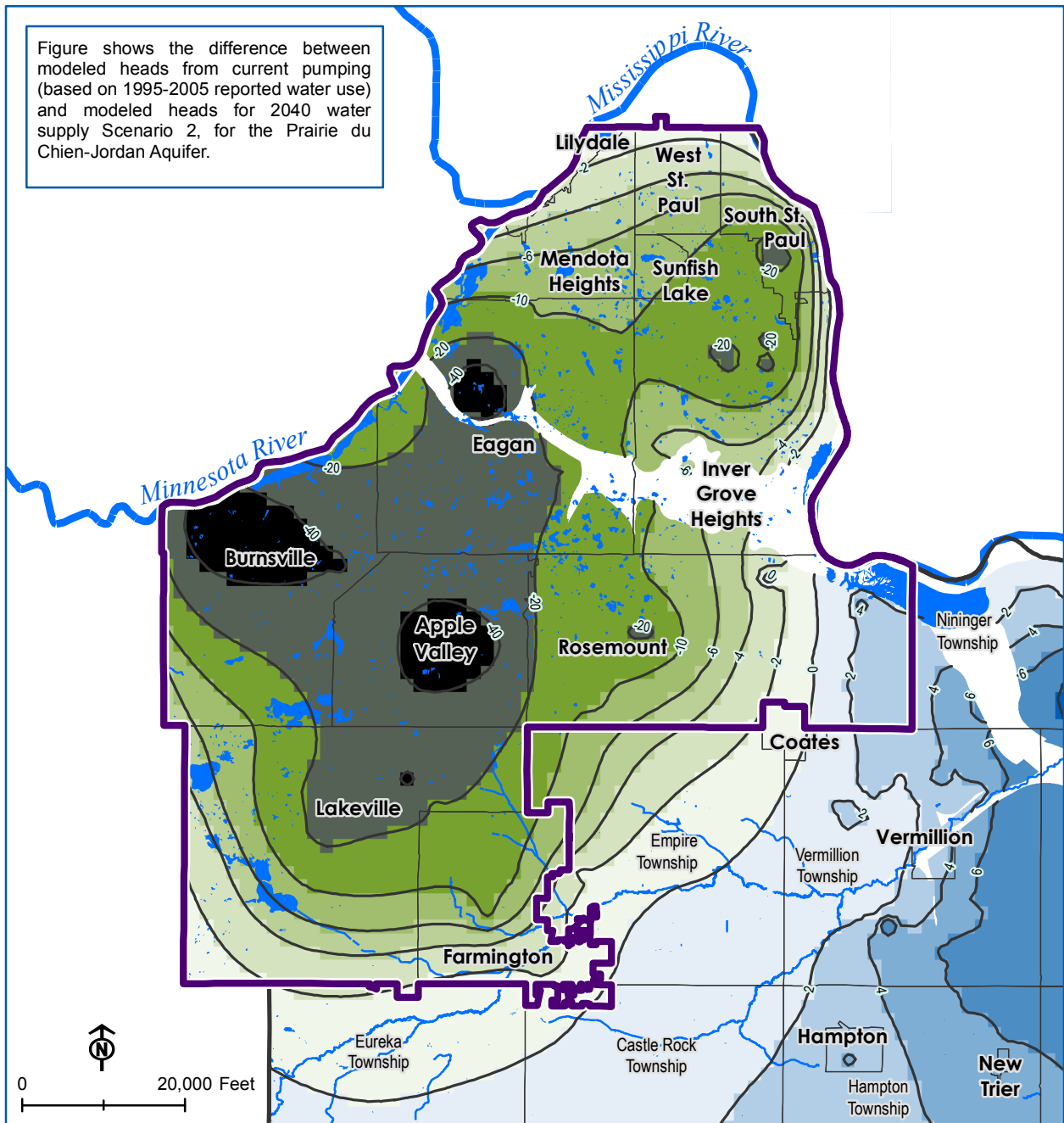

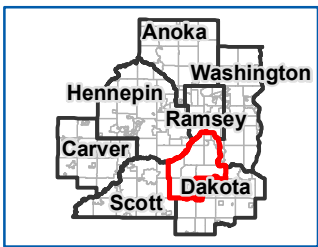


Figure shows the difference between modeled heads from current pumping (based on 1995-2005 reported water use) and modeled heads for 2040 water supply Scenario 2, for the Prairie du Chien-Jordan Aquifer.

**Legend**

Drawdown (ft)	Recovery (ft)	
0 - 2	40+	— Drawdown/Recovery Contour
2 - 4	20 - 40	□ Prairie du Chien and Jordan Absent
4 - 6	10 - 20	▭ Study Area
6 - 10	6 - 10	▭ County Boundary
10 - 20	4 - 6	▭ City/Township Boundary
20 - 40	2 - 4	— Perennial Stream
40+	0 - 2	— Waterbody

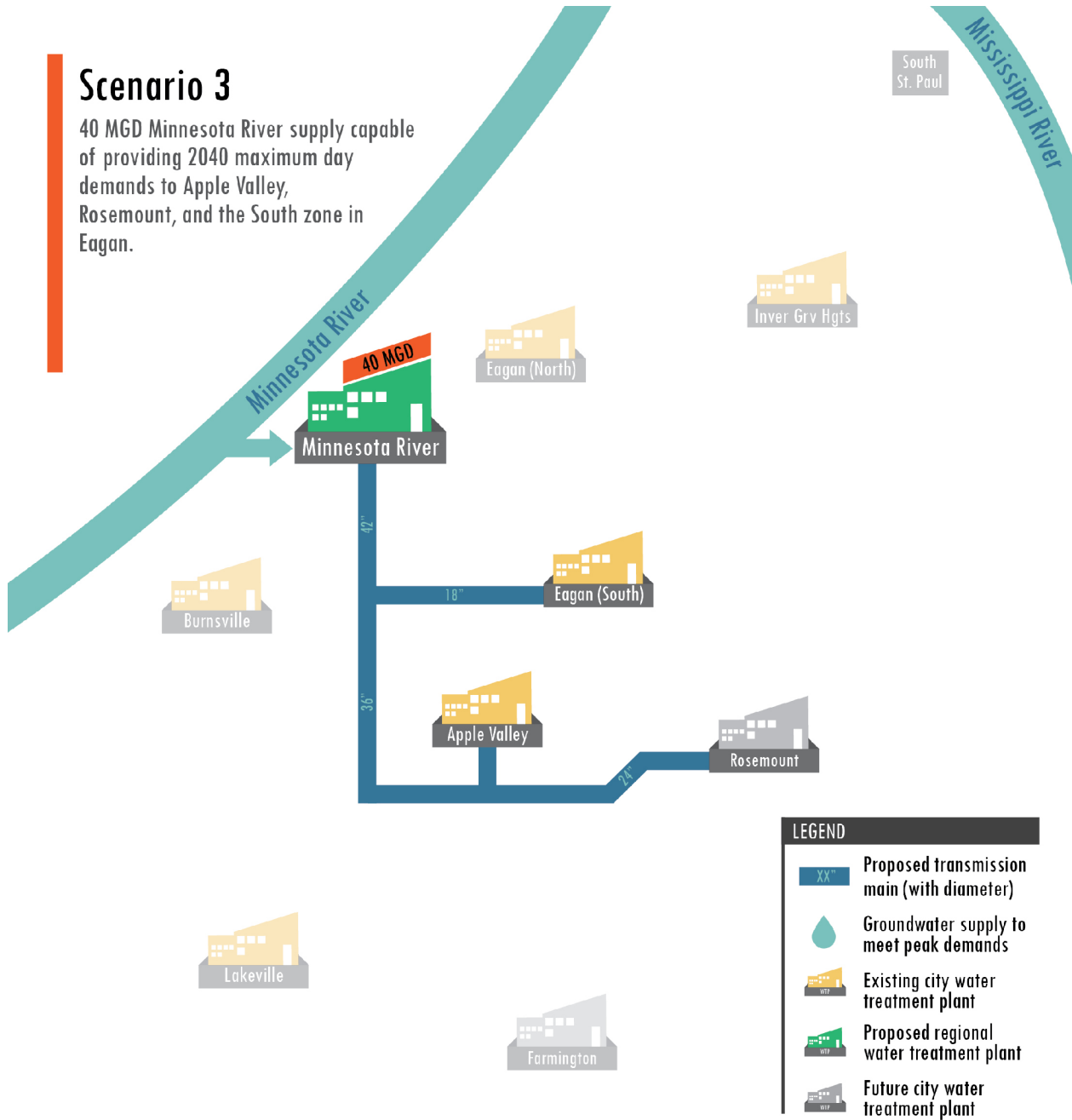
Sources: Met Council, NHD, DNR

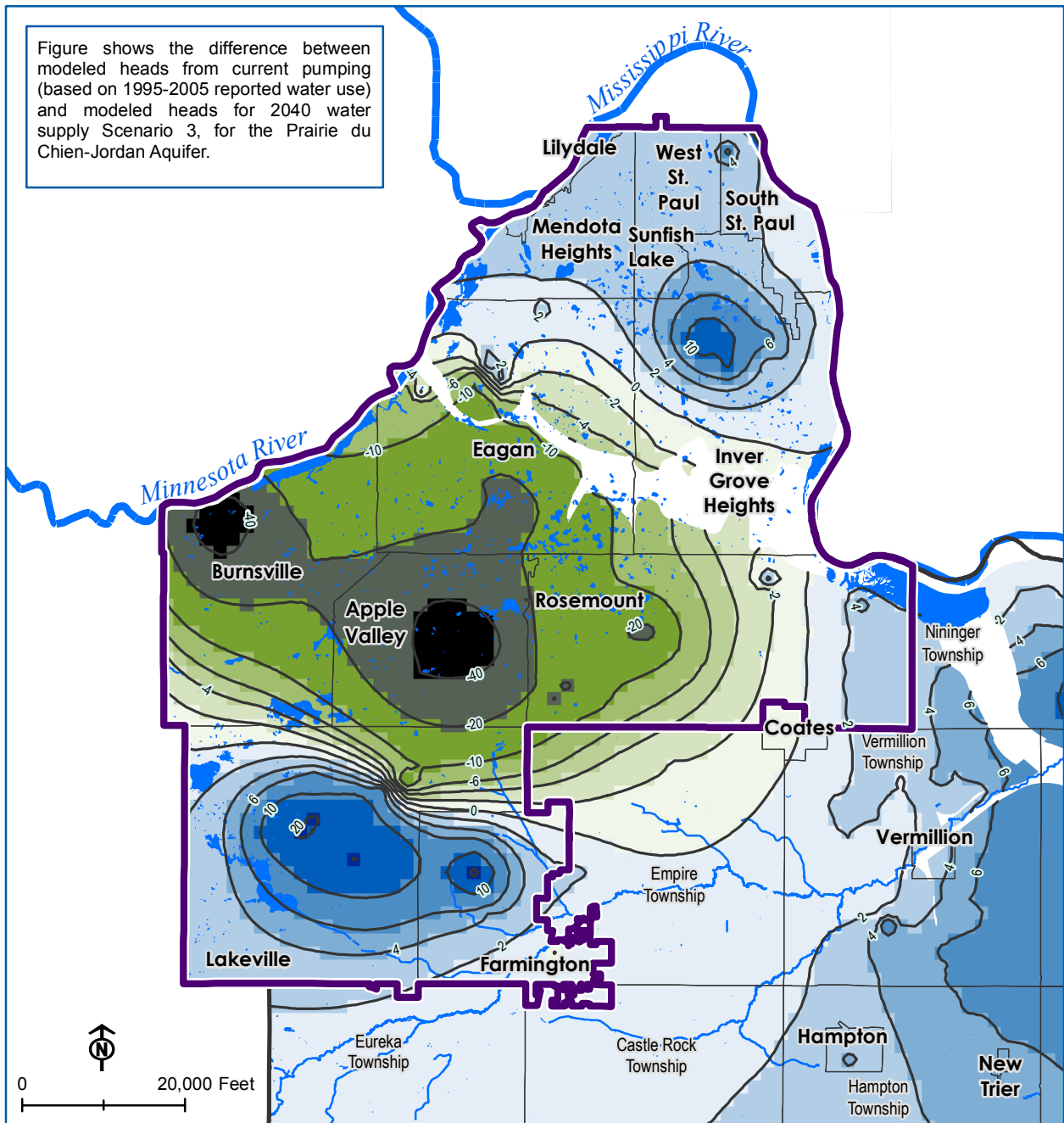
Document Path: \\mspe-gis-file\gisproj\MetCouncil\224209\map\_docs\Southeast\_Region\10\_Scenario\_2\_8x11P.mxd



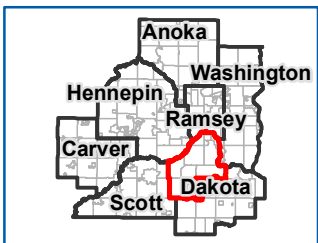
### Scenario 3

40 MGD Minnesota River supply capable of providing 2040 maximum day demands to Apple Valley, Rosemount, and the South zone in Eagan.





Legend		
<b>Drawdown (ft)</b>	<b>Recovery (ft)</b>	— Drawdown/Recovery Contour
0 - 2	40+	□ Prairie du Chien and Jordan Absent
2 - 4	20 - 40	▭ Study Area
4 - 6	10 - 20	▭ County Boundary
6 - 10	6 - 10	▭ City/Township Boundary
10 - 20	4 - 6	— Perennial Stream
20 - 40	2 - 4	— Waterbody
40+	0 - 2	

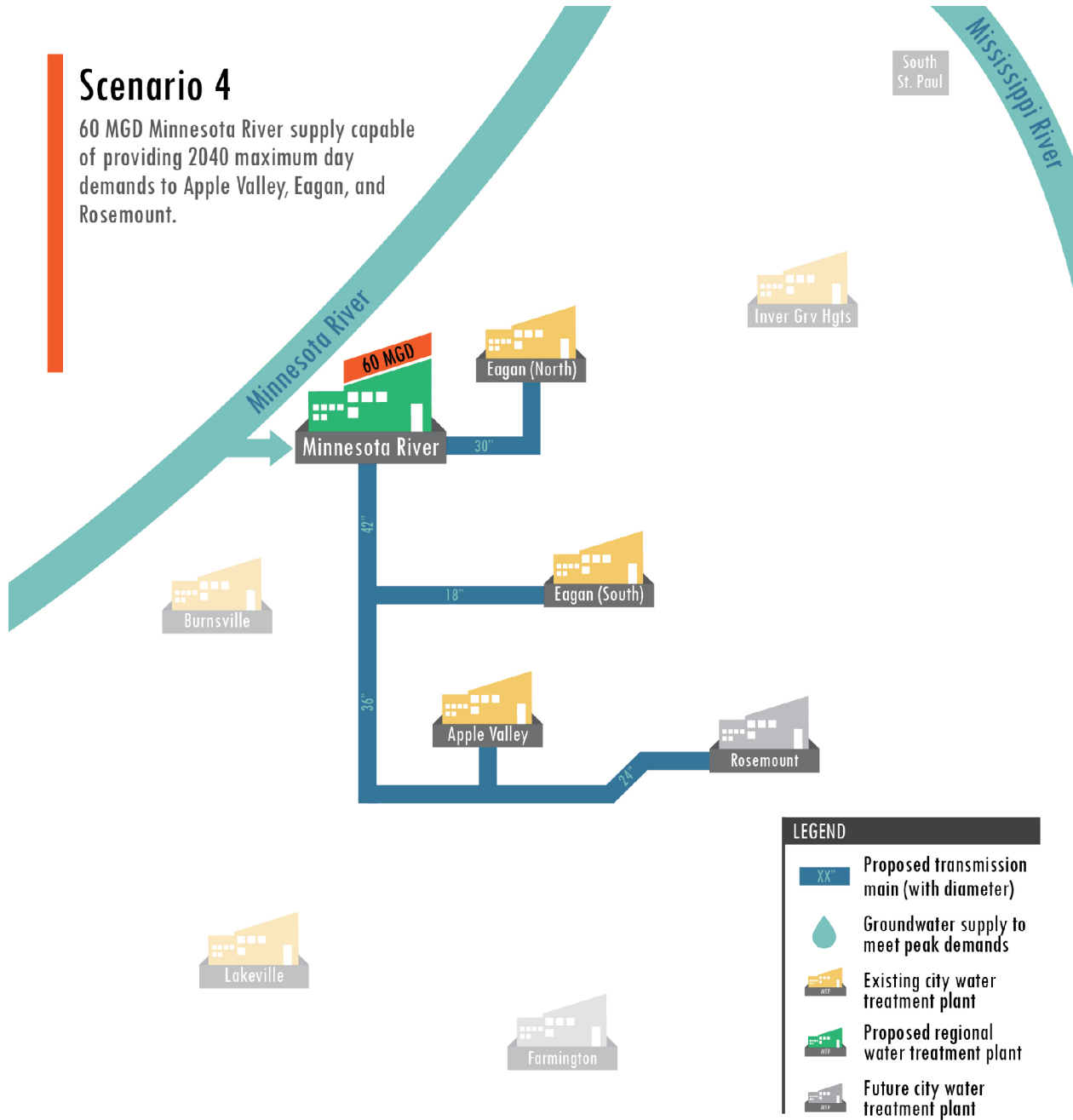


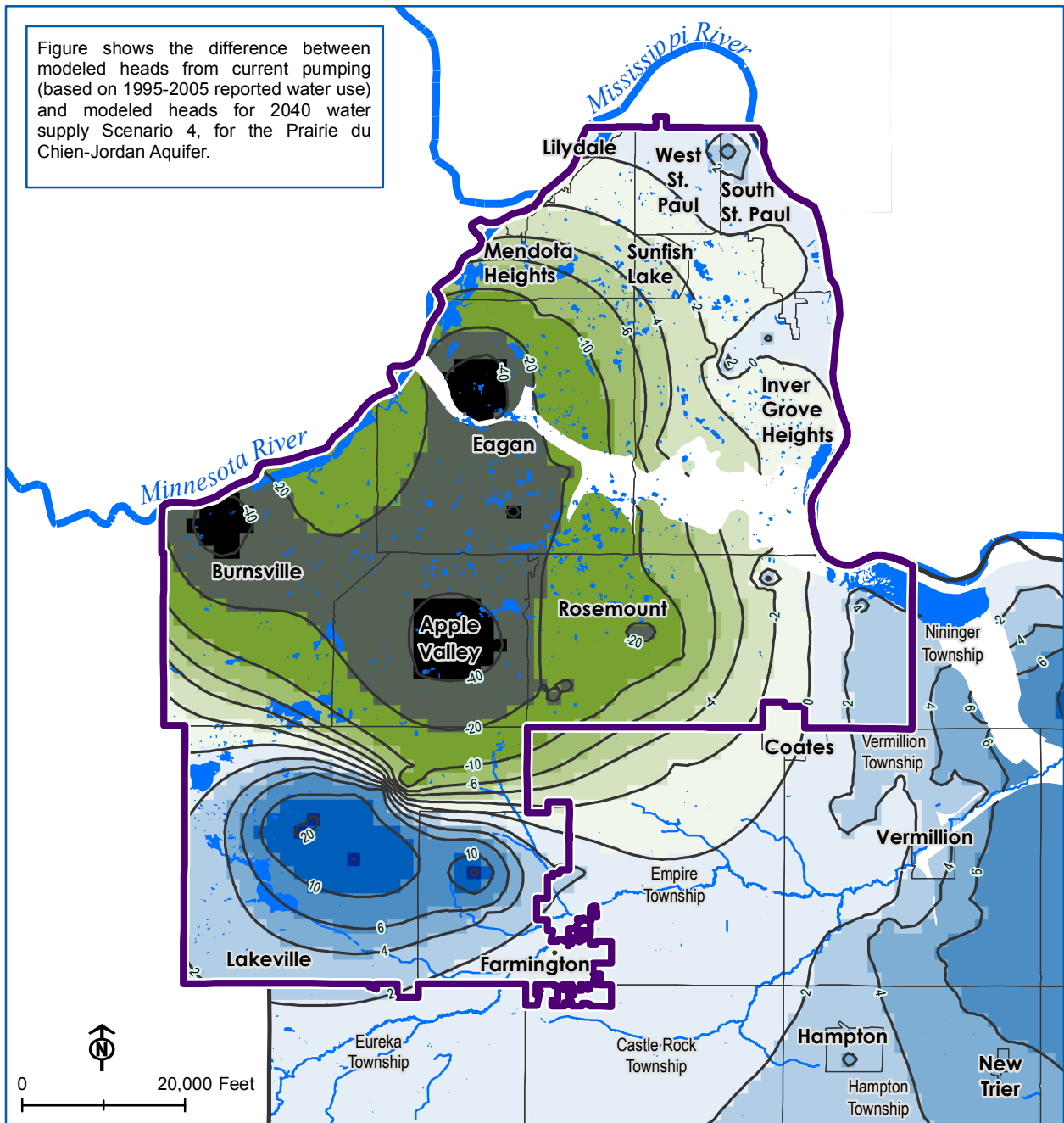




## Scenario 4

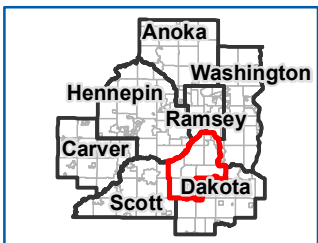
60 MGD Minnesota River supply capable of providing 2040 maximum day demands to Apple Valley, Eagan, and Rosemount.





**Legend**

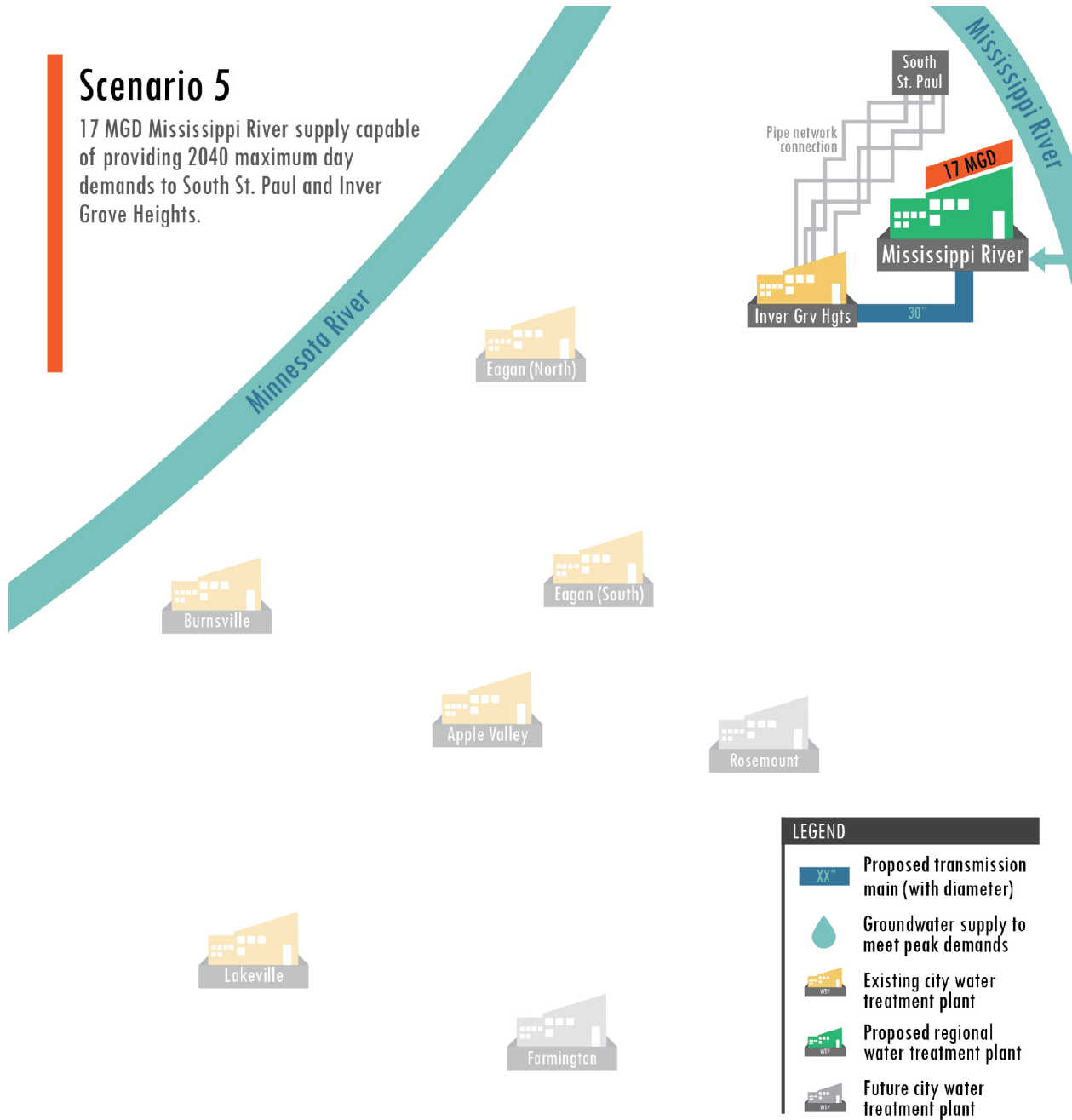
Drawdown (ft)	Recovery (ft)	
0 - 2	40+	— Drawdown/Recovery Contour
2 - 4	20 - 40	□ Prairie du Chien and Jordan Absent
4 - 6	10 - 20	▭ Study Area
6 - 10	6 - 10	▭ County Boundary
10 - 20	4 - 6	▭ City/Township Boundary
20 - 40	2 - 4	— Perennial Stream
40+	0 - 2	— Waterbody





## Scenario 5

17 MGD Mississippi River supply capable of providing 2040 maximum day demands to South St. Paul and Inver Grove Heights.

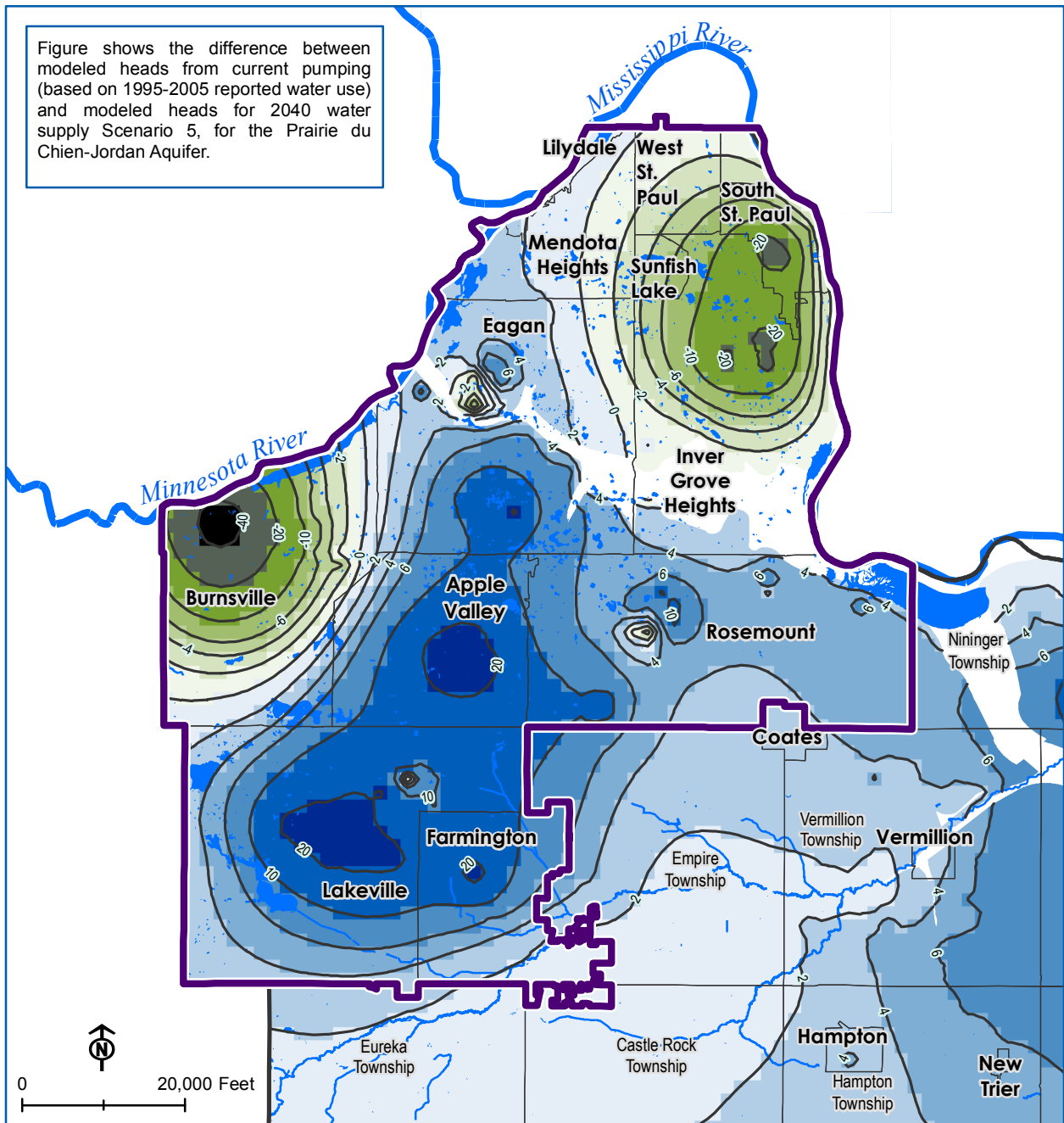


**LEGEND**

- XX" Proposed transmission main (with diameter)
- Water drop icon Groundwater supply to meet peak demands
- Yellow building icon Existing city water treatment plant
- Green building icon Proposed regional water treatment plant
- Grey building icon Future city water treatment plant


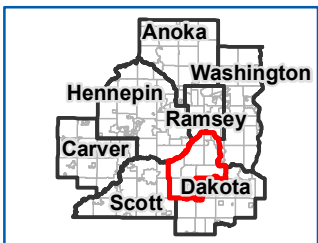


Figure shows the difference between modeled heads from current pumping (based on 1995-2005 reported water use) and modeled heads for 2040 water supply Scenario 5, for the Prairie du Chien-Jordan Aquifer.



**Legend**

Drawdown (ft)	Recovery (ft)	Symbol	Description
0 - 2	40+	—	Drawdown/Recovery Contour
2 - 4	20 - 40	□	Prairie du Chien and Jordan Absent
4 - 6	10 - 20	▭	Study Area
6 - 10	6 - 10	▭	County Boundary
10 - 20	4 - 6	▭	City/Township Boundary
20 - 40	2 - 4	▭	City/Township Boundary
40+	0 - 2	▭	City/Township Boundary
		—	Perennial Stream
		—	Waterbody



## Scenario 6

50 MGD Mississippi River supply capable of providing 2040 average day demands to all eight communities in the study area.

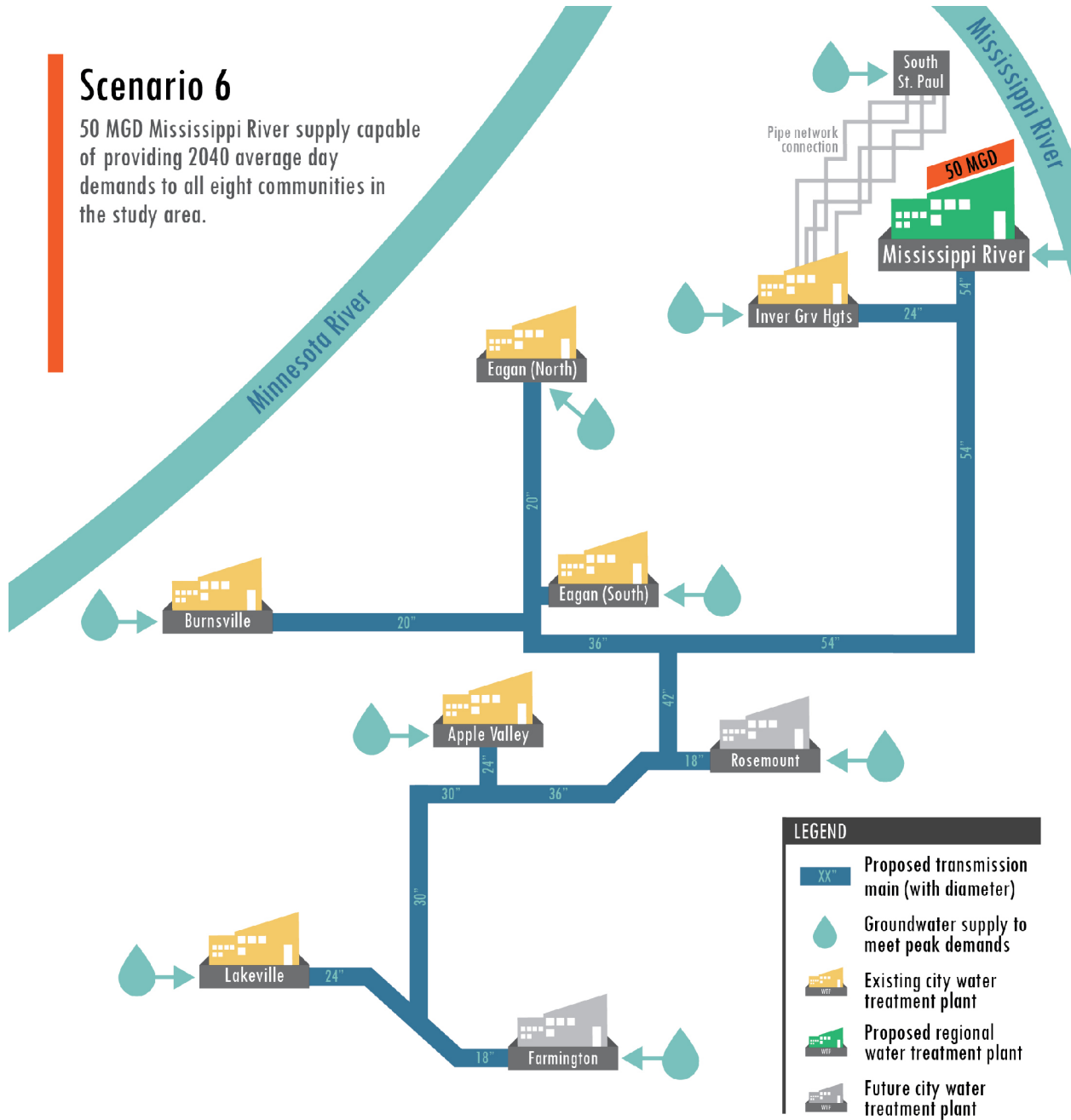
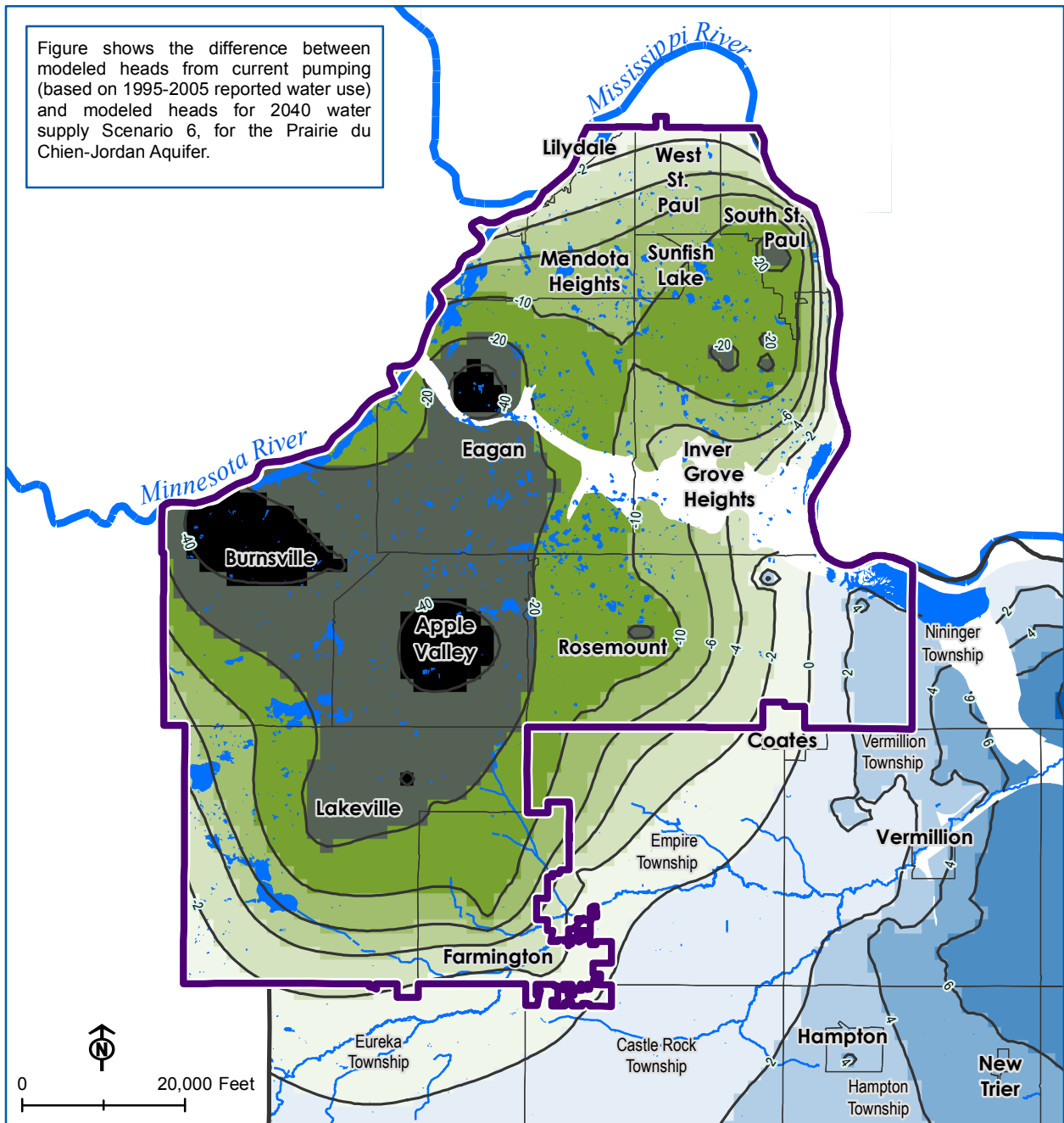



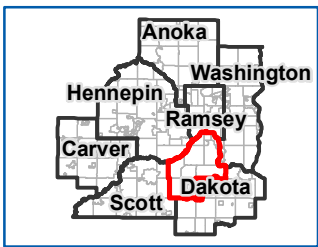


Figure shows the difference between modeled heads from current pumping (based on 1995-2005 reported water use) and modeled heads for 2040 water supply Scenario 6, for the Prairie du Chien-Jordan Aquifer.



**Legend**

Drawdown (ft)	Recovery (ft)	Symbol	Description
0 - 2	40+	—	Drawdown/Recovery Contour
2 - 4	20 - 40	□	Prairie du Chien and Jordan Absent
4 - 6	10 - 20	▭	Study Area
6 - 10	6 - 10	▭	County Boundary
10 - 20	4 - 6	▭	City/Township Boundary
20 - 40	2 - 4	—	Perennial Stream
40+	0 - 2	—	Waterbody

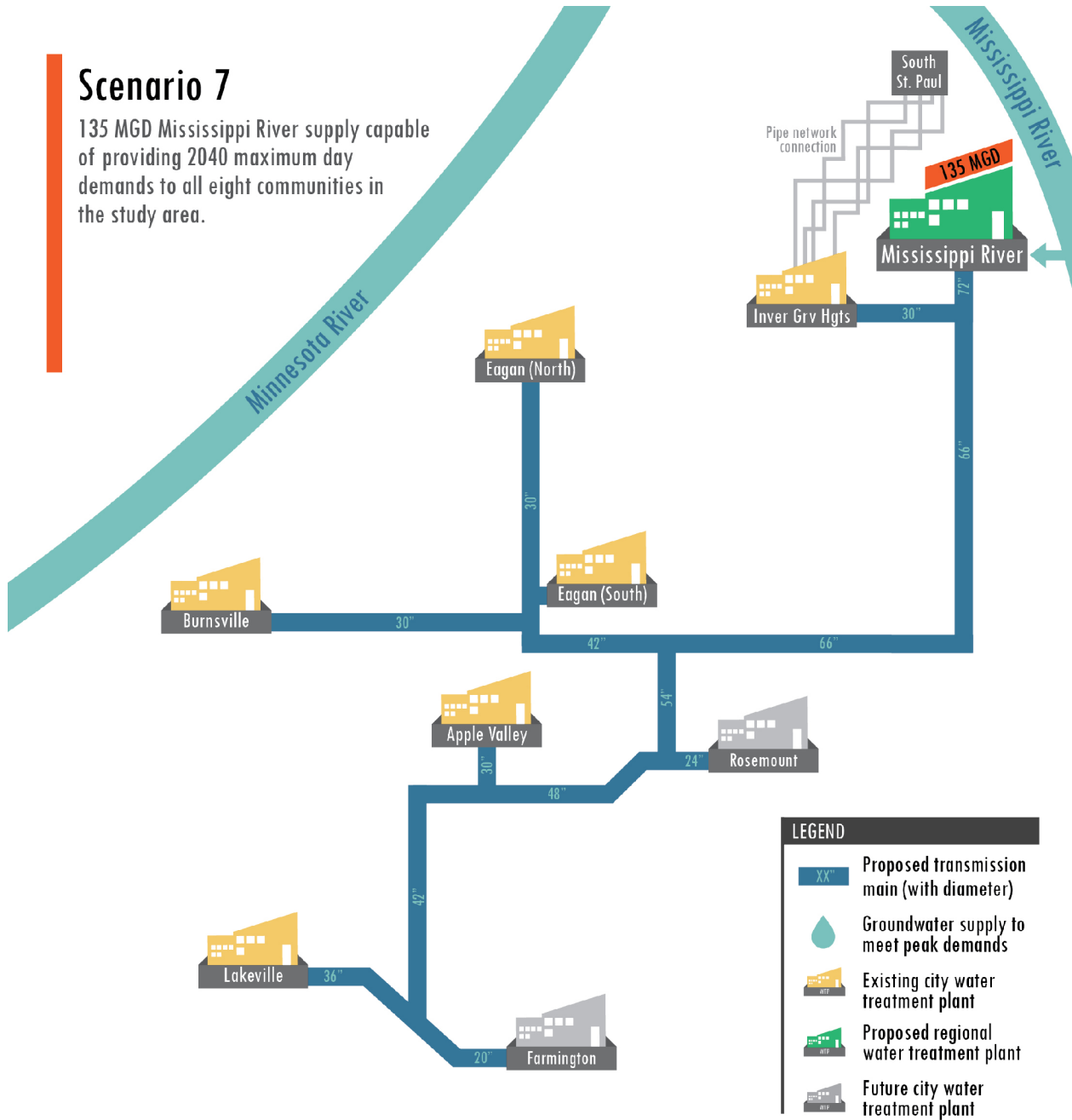
Sources: Met Council, NHD, DNR

Document Path: \\mspe-gis-file\GISProj\MetCouncil\224209\map\_docs\Southeast\_Region\18\_Scenario\_6\_8x11P.mxd



## Scenario 7

135 MGD Mississippi River supply capable of providing 2040 maximum day demands to all eight communities in the study area.

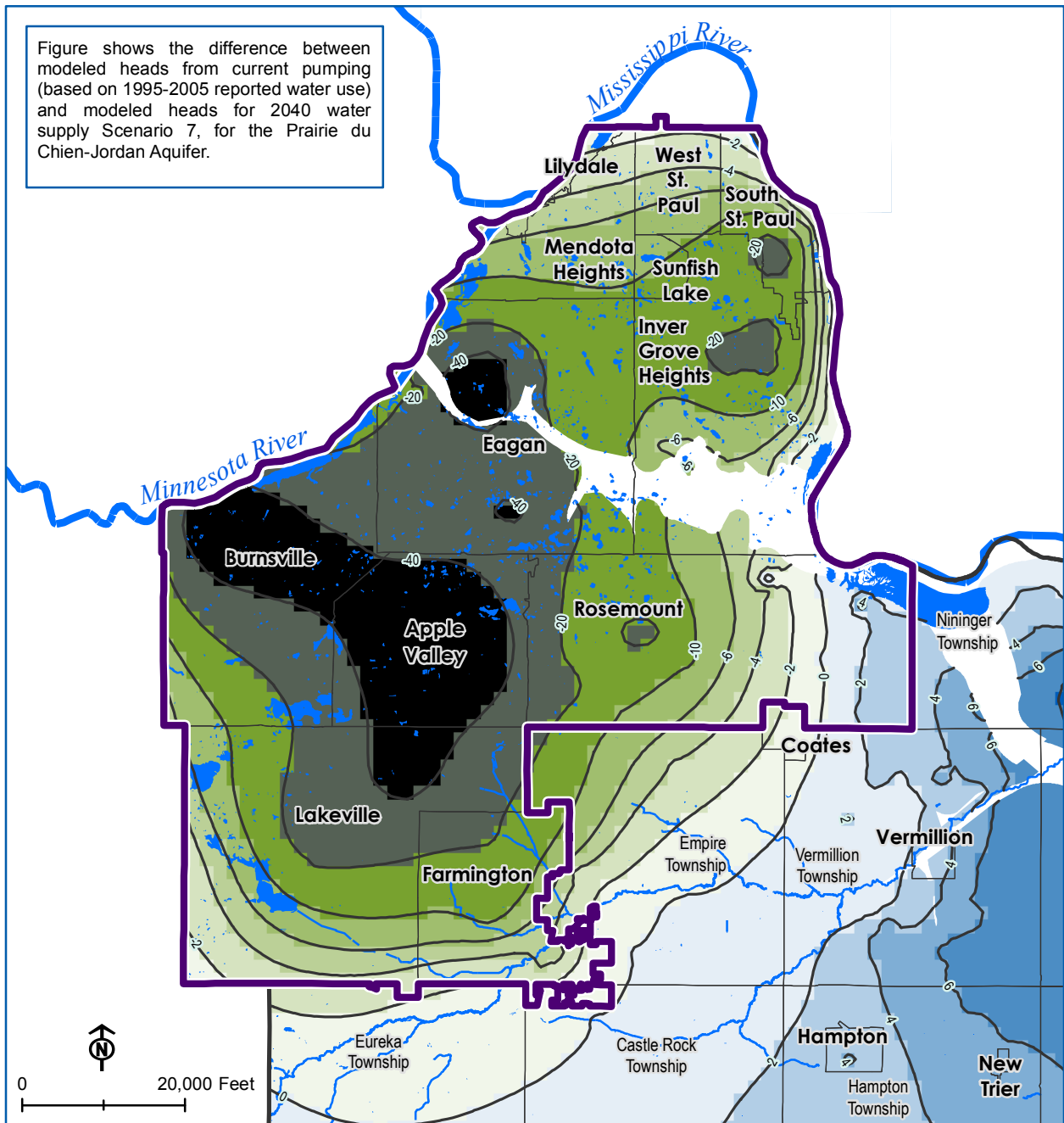


**LEGEND**

- XX" Proposed transmission main (with diameter)
- Water drop icon Groundwater supply to meet peak demands
- Yellow building icon Existing city water treatment plant
- Green building icon Proposed regional water treatment plant
- Grey building icon Future city water treatment plant


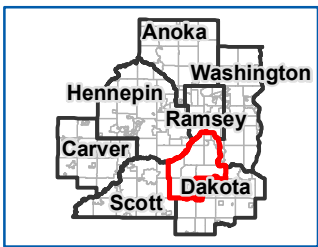


Figure shows the difference between modeled heads from current pumping (based on 1995-2005 reported water use) and modeled heads for 2040 water supply Scenario 7, for the Prairie du Chien-Jordan Aquifer.



**Legend**

Drawdown (ft)	Recovery (ft)	Symbol	Description
0 - 2	40+	—	Drawdown/Recovery Contour
2 - 4	20 - 40	□	Prairie du Chien and Jordan Absent
4 - 6	10 - 20	▭	Study Area
6 - 10	6 - 10	▭	County Boundary
10 - 20	4 - 6	▭	City/Township Boundary
20 - 40	2 - 4	—	Perennial Stream
40+	0 - 2	—	Waterbody

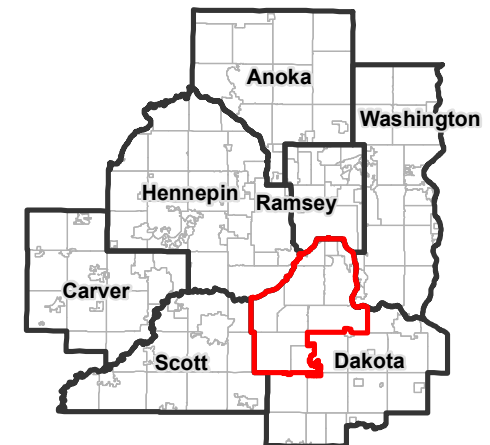
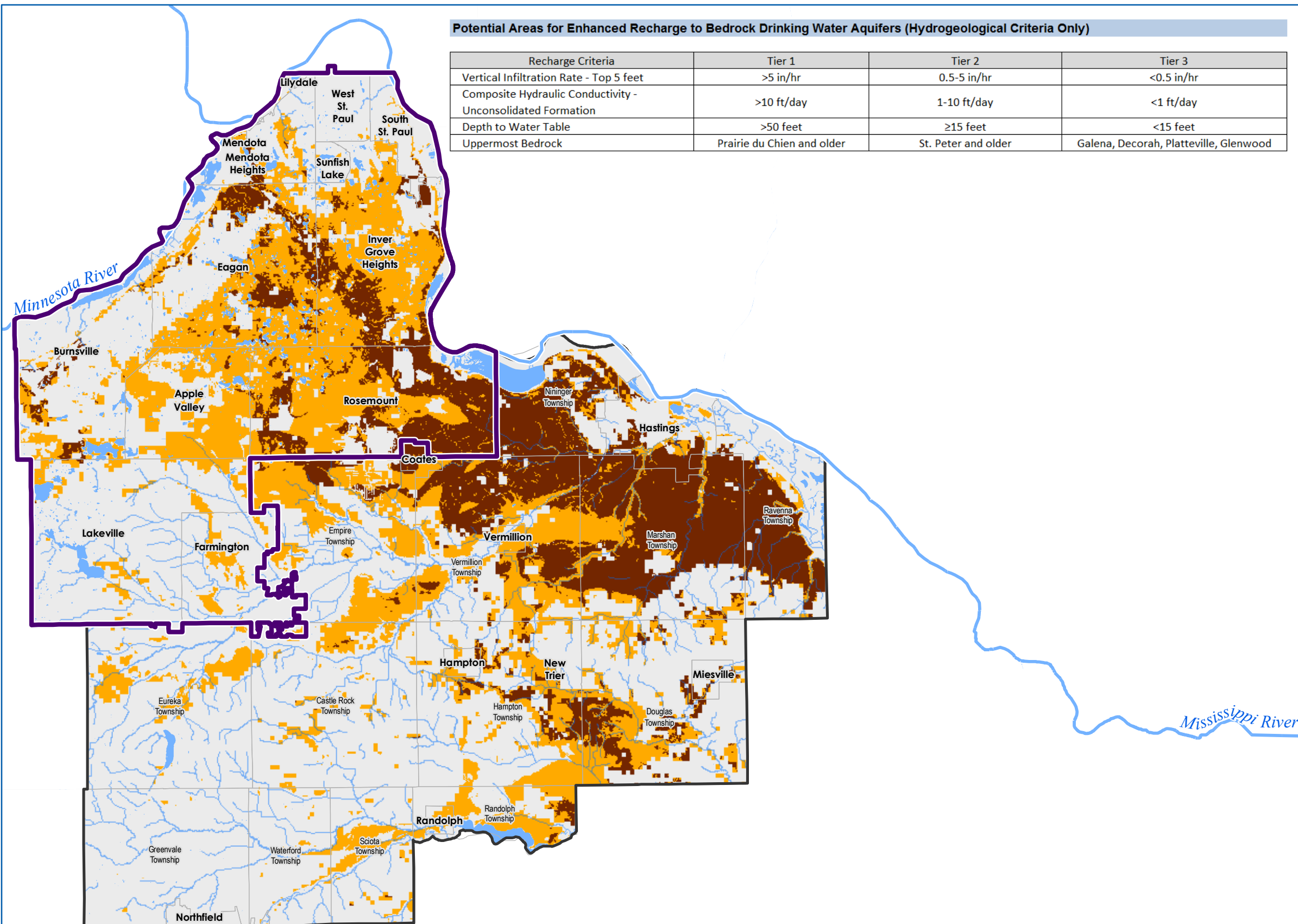
Sources: Met Council, NHD, DNR

Document Path: \\mspe-gis-file\GISProj\MetCouncil\224209\map\_docs\Southeast\_Region\20\_Scenario\_7\_8x11P.mxd



**Potential Areas for Enhanced Recharge to Bedrock Drinking Water Aquifers (Hydrogeological Criteria Only)**

Recharge Criteria	Tier 1	Tier 2	Tier 3
Vertical Infiltration Rate - Top 5 feet	>5 in/hr	0.5-5 in/hr	<0.5 in/hr
Composite Hydraulic Conductivity - Unconsolidated Formation	>10 ft/day	1-10 ft/day	<1 ft/day
Depth to Water Table	>50 feet	≥15 feet	<15 feet
Uppermost Bedrock	Prairie du Chien and older	St. Peter and older	Galena, Decorah, Platteville, Glenwood

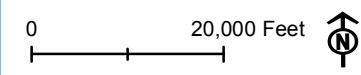


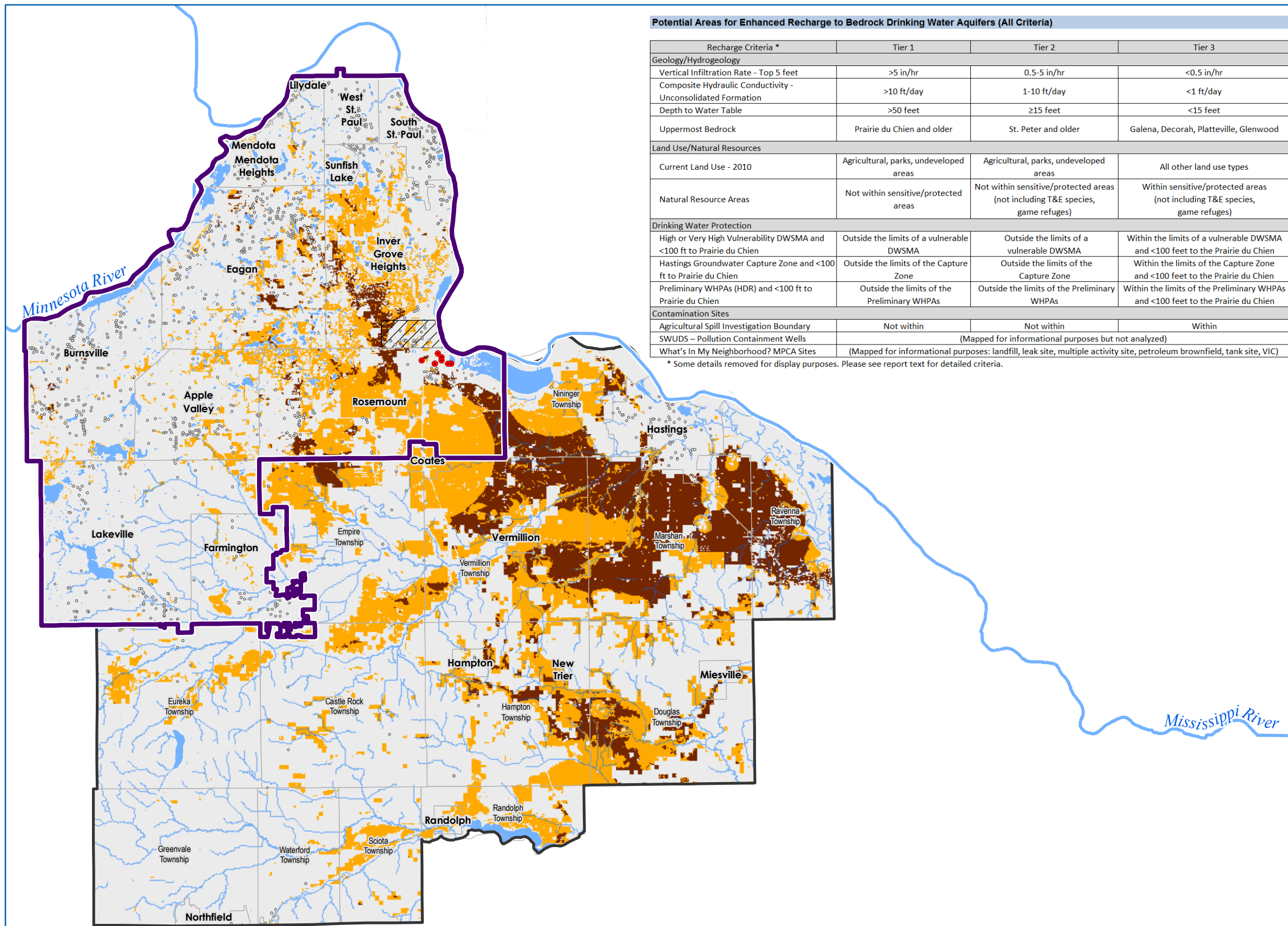
**Legend**

- Study Area
- Tier 1 Area
- Tier 2 Area
- Tier 3 Area
- County Boundary
- City/Township Boundary
- Waterbody
- River

Enhanced recharge areas are based on hydrogeological criteria only.

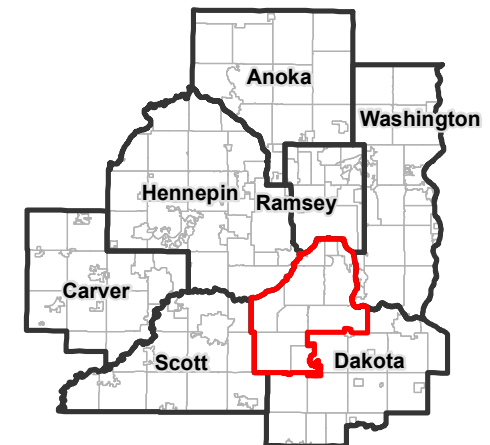
Sources: USDA NRCS, NHD, DNR





Recharge Criteria *	Tier 1	Tier 2	Tier 3
<b>Geology/Hydrogeology</b>			
Vertical Infiltration Rate - Top 5 feet	>5 in/hr	0.5-5 in/hr	<0.5 in/hr
Composite Hydraulic Conductivity - Unconsolidated Formation	>10 ft/day	1-10 ft/day	<1 ft/day
Depth to Water Table	>50 feet	≥15 feet	<15 feet
Uppermost Bedrock	Prairie du Chien and older	St. Peter and older	Galena, Decorah, Platteville, Glenwood
<b>Land Use/Natural Resources</b>			
Current Land Use - 2010	Agricultural, parks, undeveloped areas	Agricultural, parks, undeveloped areas	All other land use types
Natural Resource Areas	Not within sensitive/protected areas	Not within sensitive/protected areas (not including T&E species, game refuges)	Within sensitive/protected areas (not including T&E species, game refuges)
<b>Drinking Water Protection</b>			
High or Very High Vulnerability DWSMA and <100 ft to Prairie du Chien	Outside the limits of a vulnerable DWSMA	Outside the limits of a vulnerable DWSMA	Within the limits of a vulnerable DWSMA and <100 feet to the Prairie du Chien
Hastings Groundwater Capture Zone and <100 ft to Prairie du Chien	Outside the limits of the Capture Zone	Outside the limits of the Capture Zone	Within the limits of the Capture Zone and <100 feet to the Prairie du Chien
Preliminary WHPAs (HDR) and <100 ft to Prairie du Chien	Outside the limits of the Preliminary WHPAs	Outside the limits of the Preliminary WHPAs	Within the limits of the Preliminary WHPAs and <100 feet to the Prairie du Chien
<b>Contamination Sites</b>			
Agricultural Spill Investigation Boundary	Not within	Not within	Within
SWUDS – Pollution Containment Wells	(Mapped for informational purposes but not analyzed)		
What's In My Neighborhood? MPCA Sites	(Mapped for informational purposes: landfill, leak site, multiple activity site, petroleum brownfield, tank site, VIC)		

\* Some details removed for display purposes. Please see report text for detailed criteria.

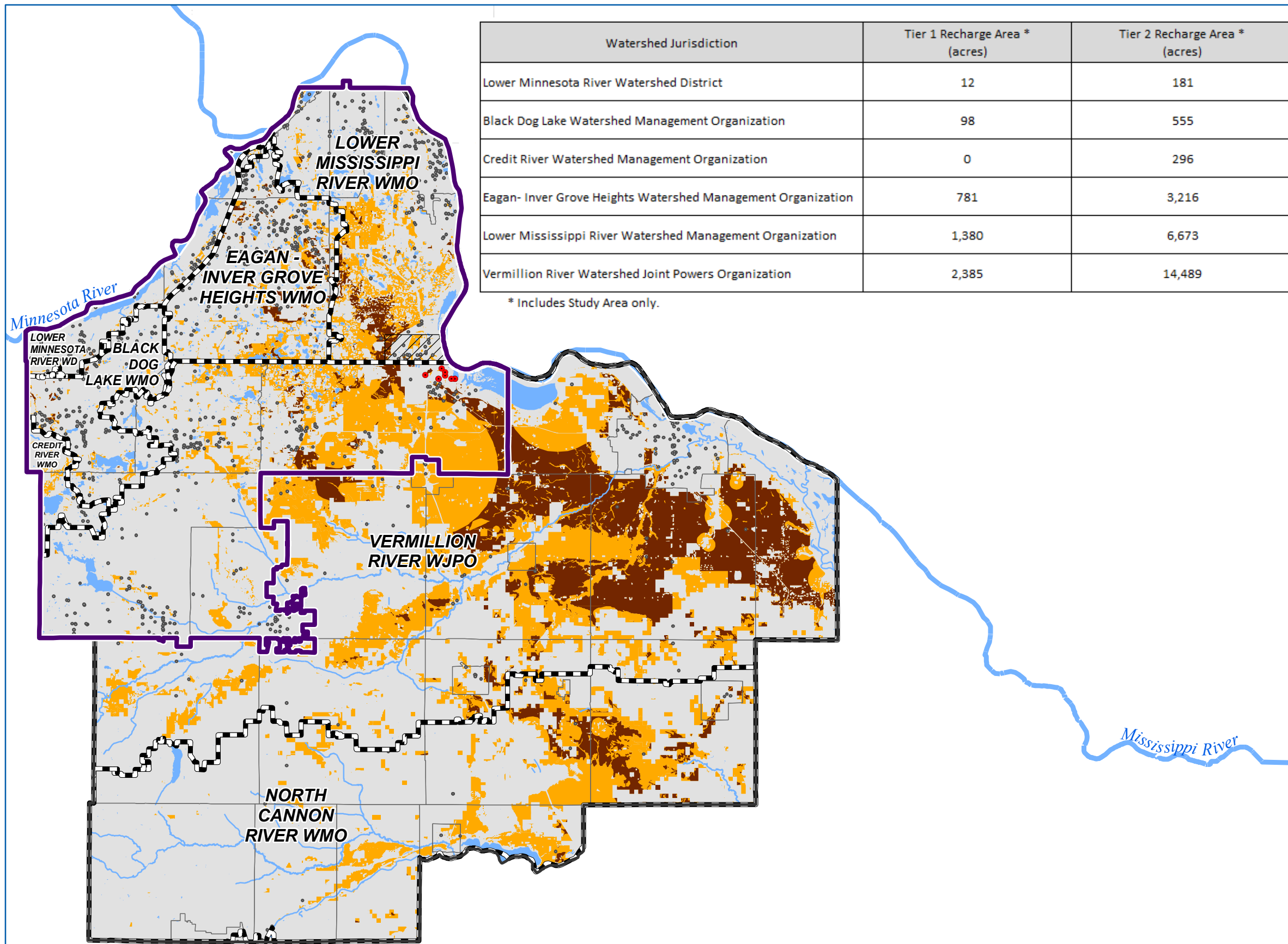


**Legend**

- Study Area
- Tier 1 Area
- Tier 2 Area
- Tier 3 Area
- Pollution Containment Well
- MPCA Site
- Special Well and Boring Construction Area
- County Boundary
- City/Township Boundary
- ~ Waterbody
- ~ Perennial Stream

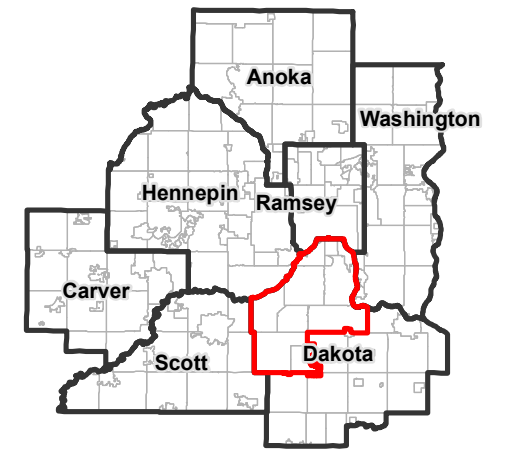
Sources: USDA NRCS, NHD, DNR, MDH

0 20,000 Feet



Watershed Jurisdiction	Tier 1 Recharge Area * (acres)	Tier 2 Recharge Area * (acres)
Lower Minnesota River Watershed District	12	181
Black Dog Lake Watershed Management Organization	98	555
Credit River Watershed Management Organization	0	296
Eagan- Inver Grove Heights Watershed Management Organization	781	3,216
Lower Mississippi River Watershed Management Organization	1,380	6,673
Vermillion River Watershed Joint Powers Organization	2,385	14,489

\* Includes Study Area only.



Legend

- Watershed Jurisdiction
- Study Area
- Tier 1 Area
- Tier 2 Area
- Tier 3 Area
- Pollution Containment Well
- MPCA Site
- Special Well and Boring Construction Area
- County Boundary
- City/Township Boundary
- Perennial Stream
- Waterbody

Sources: NHD, DNR, USDA, NRCS, MDH

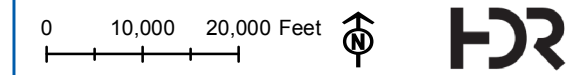
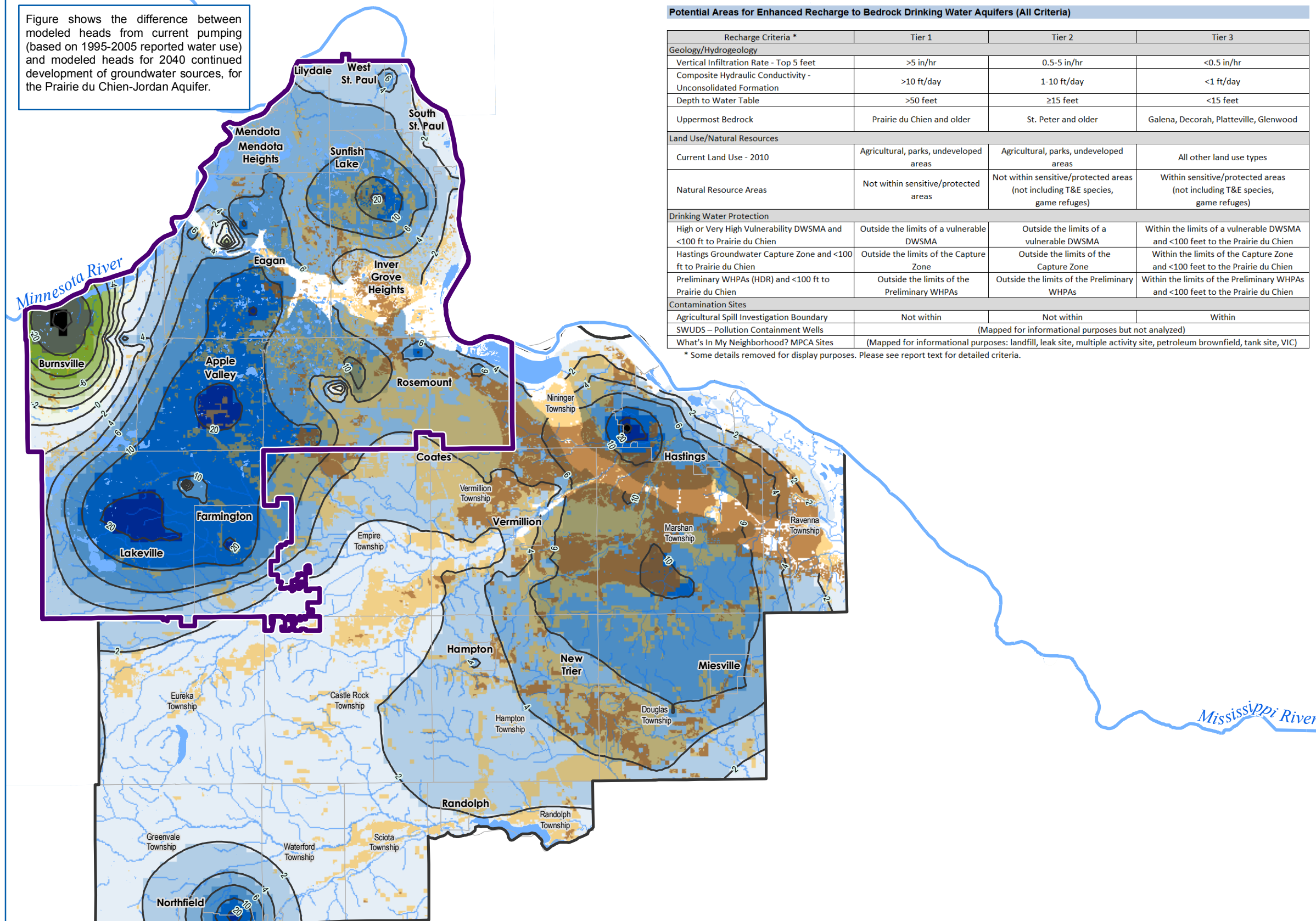
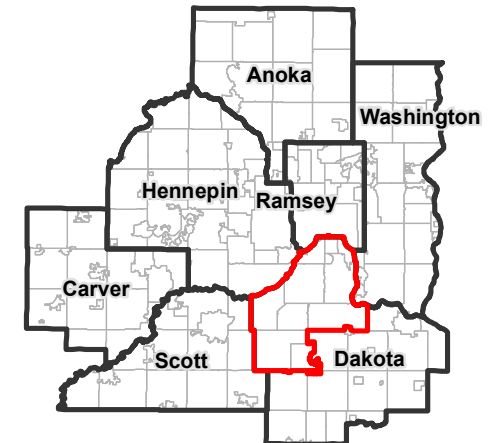


Figure shows the difference between modeled heads from current pumping (based on 1995-2005 reported water use) and modeled heads for 2040 continued development of groundwater sources, for the Prairie du Chien-Jordan Aquifer.



Potential Areas for Enhanced Recharge to Bedrock Drinking Water Aquifers (All Criteria)			
Recharge Criteria *	Tier 1	Tier 2	Tier 3
<b>Geology/Hydrogeology</b>			
Vertical Infiltration Rate - Top 5 feet	>5 in/hr	0.5-5 in/hr	<0.5 in/hr
Composite Hydraulic Conductivity - Unconsolidated Formation	>10 ft/day	1-10 ft/day	<1 ft/day
Depth to Water Table	>50 feet	≥15 feet	<15 feet
Uppermost Bedrock	Prairie du Chien and older	St. Peter and older	Galena, Decorah, Platteville, Glenwood
<b>Land Use/Natural Resources</b>			
Current Land Use - 2010	Agricultural, parks, undeveloped areas	Agricultural, parks, undeveloped areas	All other land use types
Natural Resource Areas	Not within sensitive/protected areas	Not within sensitive/protected areas (not including T&E species, game refuges)	Within sensitive/protected areas (not including T&E species, game refuges)
<b>Drinking Water Protection</b>			
High or Very High Vulnerability DWSMA and <100 ft to Prairie du Chien	Outside the limits of a vulnerable DWSMA	Outside the limits of a vulnerable DWSMA	Within the limits of a vulnerable DWSMA and <100 feet to the Prairie du Chien
Hastings Groundwater Capture Zone and <100 ft to Prairie du Chien	Outside the limits of the Capture Zone	Outside the limits of the Capture Zone	Within the limits of the Capture Zone and <100 feet to the Prairie du Chien
Preliminary WHPAs (HDR) and <100 ft to Prairie du Chien	Outside the limits of the Preliminary WHPAs	Outside the limits of the Preliminary WHPAs	Within the limits of the Preliminary WHPAs and <100 feet to the Prairie du Chien
<b>Contamination Sites</b>			
Agricultural Spill Investigation Boundary	Not within	Not within	Within
SWUDS - Pollution Containment Wells	(Mapped for informational purposes but not analyzed)		
What's In My Neighborhood? MPCA Sites	(Mapped for informational purposes: landfill, leak site, multiple activity site, petroleum brownfield, tank site, VIC)		

\* Some details removed for display purposes. Please see report text for detailed criteria.



**Legend**

- Study Area
- Tier 1 Area
- Tier 2 Area
- Tier 3 Area
- Drawdown/Recovery Contour
- Prairie du Chien and Jordan Absent

**Drawdown (ft)**

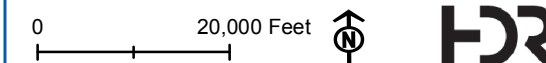
- 0 - 2
- 2 - 4
- 4 - 6
- 6 - 10
- 10 - 20
- 20 - 40
- 40+

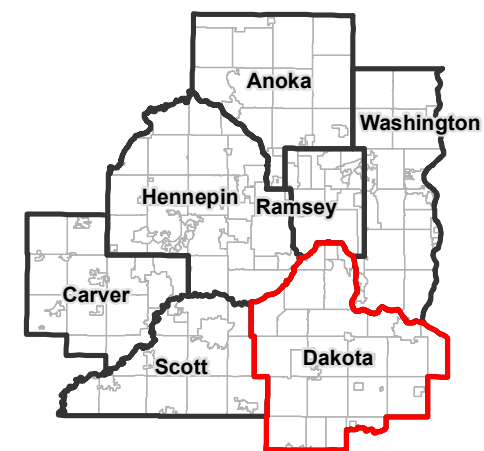
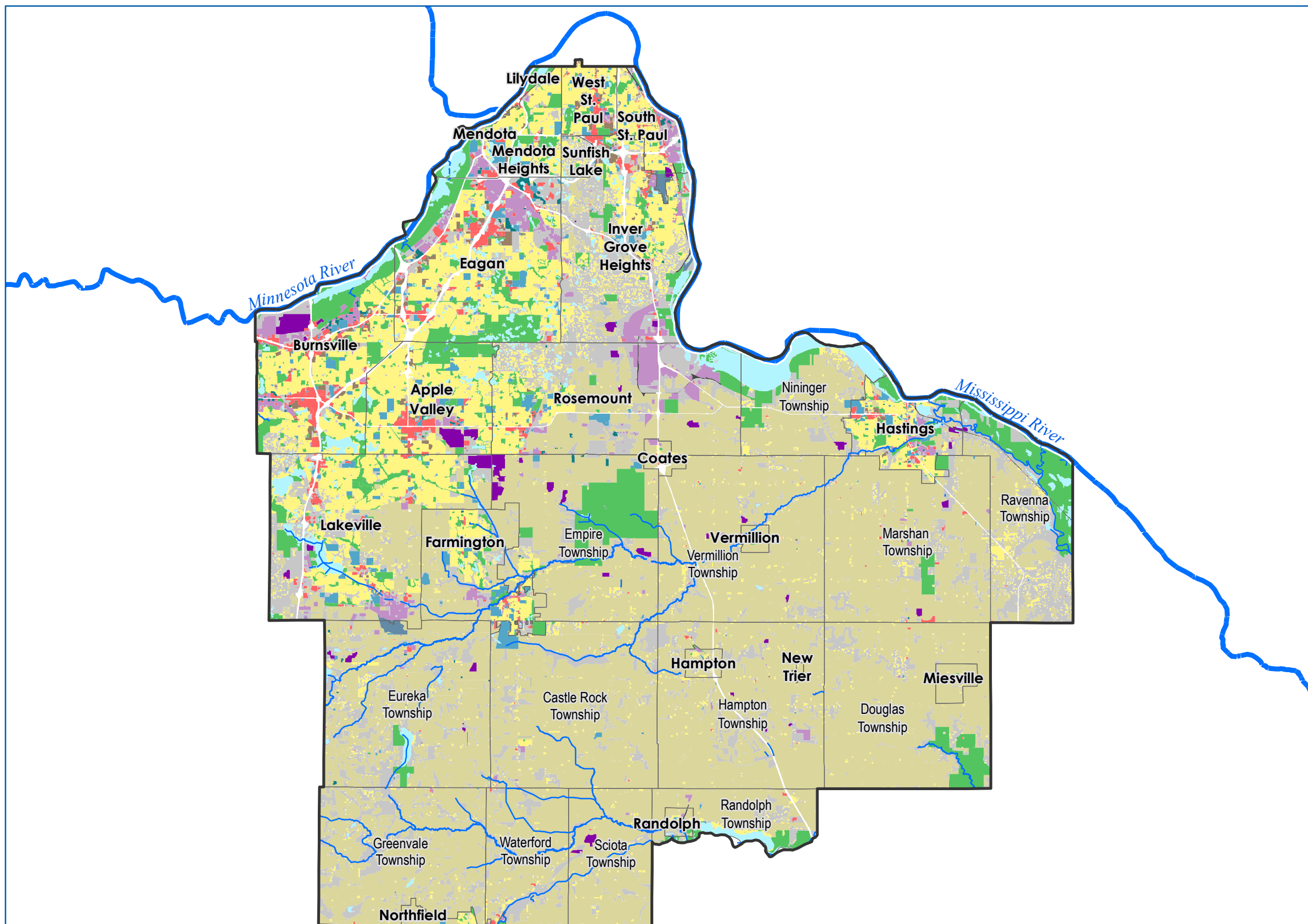
**Recovery (ft)**

- 40+
- 20 - 40
- 10 - 20
- 6 - 10
- 4 - 6
- 2 - 4
- 0 - 2

- County Boundary
- City/Township Boundary
- Waterbody
- Perennial Stream

Sources: USDA NRCS, NHD, DNR

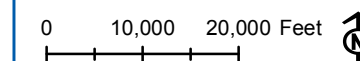


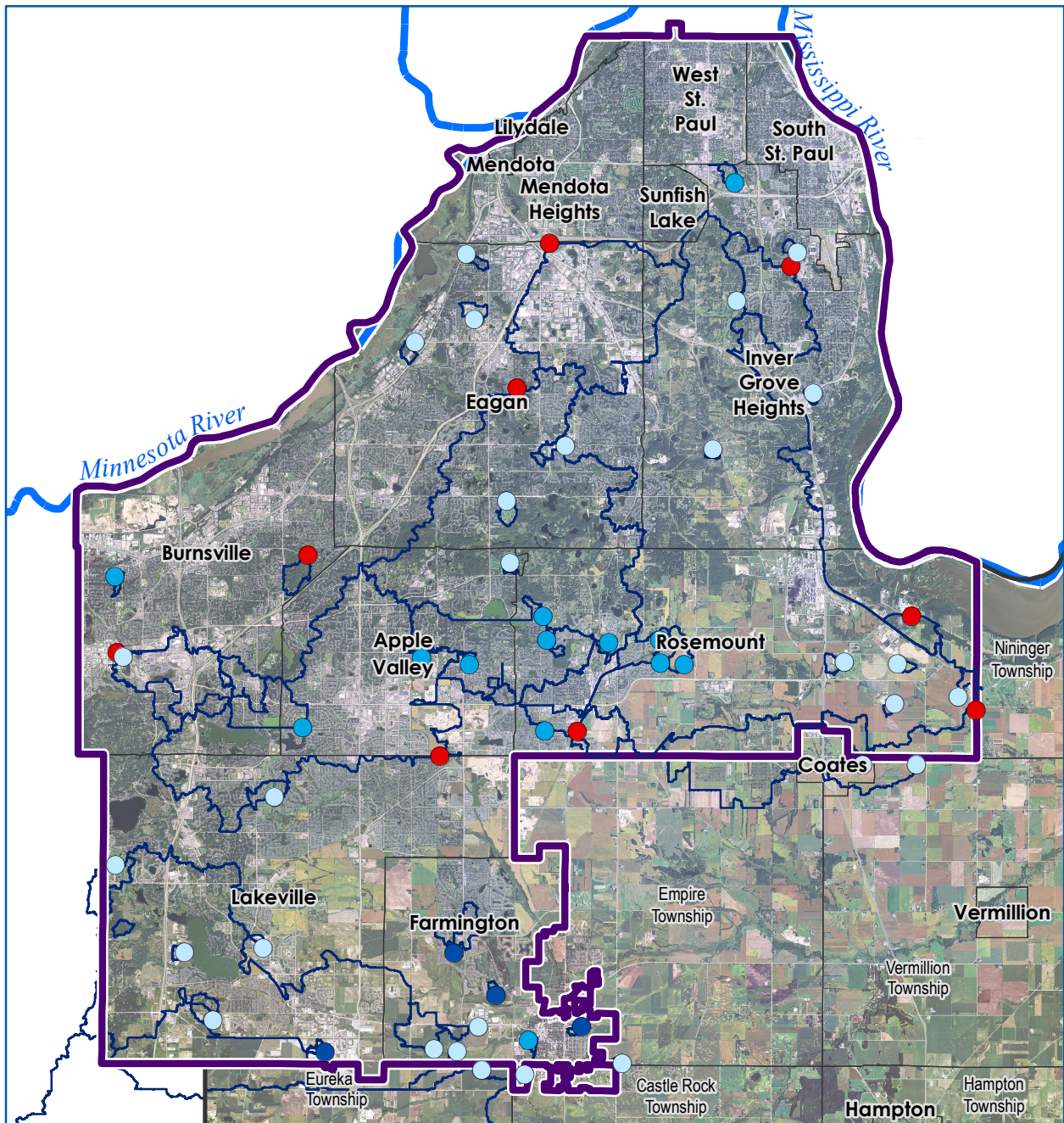


Legend

- Agricultural
- Single Family Residential
- Multifamily Residential
- Commercial
- Extractive
- Industrial
- Institutional
- Mixed Use
- Park and Recreation
- Rights-of-Way (i.e., Roads)
- Railway (inc. LRT)
- Airport
- Undeveloped
- Open Water
- County Boundary
- City/Township Boundary
- River

Sources: Met Council, NHD, DNR

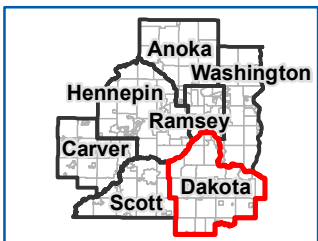




**Legend**

DNR SWUDS	Study Area
City Water Sales	County Boundary
City WECP	City/Township Boundary
Enhanced Recharge Site	
Subwatersheds	

0 2 Miles



Sources: Met Council, DNR

## Appendices

## **Appendix A1: Existing Water System Descriptions**

### **APPLE VALLEY**

The City of Apple Valley drinking water system consists of 15 wells that are actively in use, five wells that are classified as emergency wells, one elevated storage reservoir, four ground storage reservoirs, one clearwell, a centralized water treatment plant, and water main ranging in size from 6 to 24 inches in diameter. There are two main pressure zones in Apple Valley, and one smaller pressure zone. The main pressure zones consist of a high zone in the northwest part of the City, and a low zone south and east of the high zone. The two small zone is supplied by pressure reducing valves from the high zone. Seventeen of the wells draw from the Jordan aquifer, one well is open to both the Jordan Sandstone and the overlying Prairie du Chien formation, and two of the emergency wells are in the Mt. Simon formation. Three emergency wells are not connected to the water treatment plant. The wells range in capacity from 600 to 1,800 gallons per minute (gpm). Seventeen of the wells pump water to the water treatment plant, which is designed to remove iron and manganese. After filtration, chlorine and fluoride are added before the water is pumped to the distribution system.<sup>1</sup>

Apple Valley is projected to grow from a 2010 population of approximately 50,000 to a 2040 population of 65,400. Average day demand is expected to change from 8.4 MGD to 7.8 MGD over the same period. Maximum day demands are projected to be 20.0 MGD in 2040, which is a reduction from 21.0 MGD in 2010. The City is planning water storage reservoir rehabilitation and other minor utility infrastructure maintenance in the future<sup>2</sup>.

### **BURNSVILLE**

The City of Burnsville drinking water system consists of 17 wells, three elevated storage tanks, one ground storage reservoir, a water treatment plant, and approximately 210 miles distribution main ranging in size from 6 to 36 inches in diameter, with 48-inch transmission mains near the water treatment plant. The City's water treatment plant, which was originally built to treat groundwater, was expanded in 2008 to include treatment of surface water from the Kraemer Quarry, which serves a mining operation for dolomite limestone deposits by Kraemer Mining & Materials, Inc. The plant is capable of treating up to 6 MGD of water from the quarry. There are two major pressure zones in the City, including a central zone and a south central zone, which support 11 subsidiary pressure zones. Water can be pumped from the central zone to the south central zone, which can provide supplemental supply back to the central zone on demand through a pressure reducing valve.

---

<sup>1</sup> Wellhead Protection Plan Part 2 (Amendment), City of Apple Valley, June 2011

<sup>2</sup> Capital Improvement Plan, City of Apple Valley, October 2013



Fourteen of the City's wells draw from the Jordan aquifer, and three of the wells are open to the Mt. Simon/Hinckley formation. The wells range in capacity from 800 to 1,700 gpm. The water treatment plant, including the surface water expansion to withdraw from the Kraemer Quarry, has a design capacity of 24 MGD and a short-term treatment capacity of 30 MGD. Treatment practices include filtration, iron and manganese oxidation, chlorination, and fluorination.<sup>3</sup>

Burnsville is projected to grow from a 2010 population of 61,400 to a 2040 population of 67,000. Average day demand is expected to decrease from 8.4 MGD to 8.3 MGD over the same period. Maximum day demands are projected to reach 24.3 MGD in 2040 with a peak groundwater demand of 19.1 MGD. The City is not currently planning to expand existing treatment capacity. Future studies related to supply of water to Savage may recommend expansion.

#### **EAGAN**

The City of Eagan drinking water system consists of 21 wells, one elevated and five ground storage reservoirs, two water treatment plants, and over 300 miles of water main ranging in size from 6 to 30 inches in diameter. There are four pressure zones in the City, including the High Pressure Zone, Intermediate Pressure Zone, Zone 4, and Low Pressure Zone. The pressure zones are separated by pressure reducing valves/stations. Nineteen of the 21 the wells draw from the Jordan aquifer, while the remaining 2 draw from the Hinckley aquifer. The wells range in capacity from 325 to 1,400 gpm. Water is pumped from each well to one of the two water treatment plants, where iron and manganese is removed, and chlorination and fluorination are provided. After treatment, water is stored in a clearwell and pumped to the distribution system as needed<sup>4</sup>.

Eagan is projected to grow from a 2010 population of 70,500 to a 2040 population of 74,270. Average day demand is expected to increase slightly from 10.1 MGD to 10.3 MGD over the same period. Maximum day demands are projected to reach 27.3 MGD in 2040. The City is planning to develop additional wells and make improvements to existing system to meet future demands as needed.

#### **FARMINGTON**

The City of Farmington drinking water system consists of seven wells, one elevated and one ground storage reservoir, and water main ranging in size from 6 to 24 inches in diameter. The distribution system operates under a single pressure zone<sup>5</sup>. Three of the seven wells are open to the Prairie du Chien aquifer, and the other four wells draw from the Jordan aquifer<sup>6</sup>. The wells range in capacity from 600 to 2,000 gpm. The City provides chlorination and fluoridation at each wellhouse before water is pumped through the distribution system.

Farmington is projected to grow from a 2010 population of 20,500 to a 2040 population of 31,500. Average day demand is expected to increase from 2.6 MGD to 3.3 MGD over the same period. Maximum day demands are projected to reach 10 MGD in 2040.

---

<sup>3</sup> Water Supply Plan, City of Burnsville, February 2008

<sup>4</sup> Water Supply and Distribution Plan, City of Eagan, July 2008

<sup>5</sup> Water Supply and Distribution Plan, City of Farmington, March 2009

<sup>6</sup> Wellhead Protection Plan Part I, City of Farmington, May 2004

The City is planning to develop additional wells and expand the distribution system to meet growing demands. The City ultimately plans to add a water treatment plant.

#### **INVER GROVE HEIGHTS**

The City of Inver Grove Heights drinking water system consists of seven wells, five storage facilities including two ground reservoirs, three elevated tanks, a central water treatment plant, and water main ranging in size from 6 to 30 inches in diameter. There are four pressure zones in the City, including the North Service Area, Asher Service Area, South Grove Service Area, and Reduced Pressure Service Area. The Reduced Pressure Service Area is served by a pressure reducing valve from the South Grove Service Area. The Babcock Booster Station pumps water from South Grove Service Area to the Asher Service Area. The North Booster Station pumps water from the Asher Service Area to the North Service Area. Five of the wells draw from the Jordan aquifer, and one well draws from the Mt. Simon/Hinckley aquifer. The wells range in capacity from 1,000 to 1,200 gpm. The City's treatment process includes iron and manganese removal, fluoridation, and chlorination<sup>7</sup>.

Inver Grove Heights is projected to grow from a 2010 population of 31,541 to a 2040 population of 47,600. Average day demand is expected to increase from 3.0 MGD to 4.0 MGD over the same period. Maximum day demands are projected to reach 10.5 MGD in 2040. The City is planning to expand the system through development of additional wells and wellhouses as growth occurs, and additional water main extensions to serve the northwest area.

#### **LAKEVILLE**

The City of Lakeville drinking water system consists of 17 wells, four elevated storage towers, one ground storage reservoir, a water treatment plant, and water main ranging in size from 6 to 30 inches in diameter<sup>8</sup>. The distribution system operates under three pressure zones, including a Normal Zone supplied from the water treatment plant, and two reduced pressure zones serving lower elevations through pressure reducing valves<sup>9</sup>. Fifteen of the wells are open to the Prairie du Chien-Jordan aquifer, and the other wells draw from the Franconia-Ironton-Galesville aquifer. The wells range in operating capacity from 500 to 1,200 gpm. The City's water treatment plant, which was built in 1998 and expanded in 2001, provides chlorine and potassium permanganate treatment to oxidize iron and manganese. Chlorine, fluoride, and potassium orthophosphate are added to the filtered water before it is pumped to the distribution system.

Lakeville is projected to grow from a 2010 population of 57,997 to a 2040 population of 80,917. Average day demand is expected to increase from 6.4 MGD to 9.5 MGD over the same period. Maximum day demands are projected to reach 29.4 MGD in 2040. The City is planning to develop additional wells and storage facilities, extend water main, and make improvements to the existing water treatment plant to meet future demands, as needed.

---

<sup>7</sup> Comprehensive Plan, City of Inver Grove Heights, March 2010

<sup>8</sup> Comprehensive Water Plan Update, City of Lakeville, November 2013

<sup>9</sup> Comprehensive Water Plan Update, City of Lakeville, November 2013

## **ROSEMOUNT**

The City of Rosemount drinking water system consists of eight wells, four elevated storage tanks, and over 100 miles of watermain ranging in size from 6 to 16 inches in diameter. There are two pressure zones in the City, an eastern zone and a western zone, separated by a pressure reducing valve. All of the wells draw from the Jordan aquifer and range in capacity from 400 to 1,600 gpm. The City currently provides chlorination, fluoridation and polyphosphate addition (for iron and manganese sequestration) at the wellhouses.

Rosemount is projected to grow from a 2010 population of 21,932 to a 2040 population of 34,537. Average day demand is expected to increase from 2.8 MGD to 3.9 MGD over the same period. Maximum day demands are projected to reach 11.7 MGD in 2040. The City is planning to develop additional wells to meet demands and plans to construct up to three water filtration plants<sup>10</sup> in the future which would treat groundwater from the existing and projected wells to improve the aesthetic quality of the water by removing iron and manganese.

## **SOUTH ST. PAUL**

The City of South St. Paul drinking water system consists of seven wells, two elevated and two ground storage tanks, and watermain that typically ranges in size from 6 to 12 inches in diameter. South St. Paul is divided into three pressure zones. There is a southern and northern zone directly supplied by groundwater wells, and a western zone that is higher and supplied by pumps from the northern pressure zone. Five of the wells are open to only the Jordan aquifer, while two of the wells draw from both Prairie du Chien and Jordan formations. The wells range in capacity from 900 to 2,100 gpm. The City currently provides chlorination, fluoridation and polyphosphate addition at the wellhouses<sup>11</sup>.

South St. Paul is projected to grow from a 2010 population of 19,900 to a 2040 population of 22,482. Average day demand is expected to increase from 2.8 MGD to 3.6 MGD over the same period. Maximum day demands are projected to reach 6.5 MGD in 2040. The City is not planning to develop additional wells or alternative water sources, as existing infrastructure is expected to meet projected demands.<sup>12</sup>

---

<sup>10</sup> Comprehensive Water System Plan, City of Rosemount, 2007

<sup>11</sup> Part I Wellhead Protection Plan, City of South St. Paul, February 2013

<sup>12</sup> Water Supply Plan, City of South St. Paul,

## Appendix A2: Surface Water Evaluation

### INTRODUCTION

HDR examined the potential of supplying the Southeast Metro study area fully or partially with surface water. In this section, two potential diversion locations were evaluated and considered representative of available surface water supply. The first location is on the Minnesota River near Fort Snelling State Park. The second location is the Mississippi River below the confluence with the Minnesota River, near St. Paul.

### DRAINAGE AREAS AND WATERSHED DESCRIPTION

The watershed drainage areas were determined at these representative potential surface water diversion locations using the U.S. Geological Survey (USGS) National Elevation Dataset (NED). Table A2-1 lists these locations and associated drainage area. To show the relative sizes of both river drainage areas, the Mississippi River was delineated just above the confluence with the Minnesota River and also at the representative potential diversion site near St. Paul. The drainage areas collectively cover all or portions of three states and 72 counties, listed in Table A2-2.

**Table A2-1. Basin Drainage Areas to Potential Surface Water Supply Diversions**

Location	Cumulative Drainage Area (mi <sup>2</sup> )
Minnesota River at Fort Snelling State Park	16,907
Mississippi River above Confluence with Minnesota River	19,936
Mississippi River at Saint Paul	36,887

**Table A2-2. States and Counties within Basin Drainage Areas**

Iowa	Minnesota	Minnesota
Emmet	Hennepin	Sherburne
Kossuth	Hubbard	Sibley
Winnebago	Isanti	St. Louis
	Itasca	Stearns
Minnesota	Jackson	Steele
Aitkin	Kanabec	Stevens
Anoka	Kandiyohi	Swift
Becker	Lac Qui Parle	Todd
Beltrami	Le Sueur	Traverse
Benton	Lincoln	Wadena
Big Stone	Lyon	Waseca
Blue Earth	Martin	Washington
Brown	McLeod	Watonwan
Carlton	Meeker	Wright
Carver	Mille Lacs	Yellow Medicine
Cass	Morrison	
Chippewa	Murray	South Dakota
Chisago	Nicollet	Brookings
Clearwater	Otter Tail	Codington
Cottonwood	Pipestone	Day
Crow Wing	Pope	Deuel
Dakota	Ramsey	Grant
Douglas	Redwood	Marshall
Faribault	Renville	Roberts
Freeborn	Rice	
Grant	Scott	

The Mississippi River above the confluence with the Minnesota River includes 19,936 square miles. The upper portion of the Mississippi River watershed consists largely of deciduous forests and lakes. The lower portion of this watershed is cultivated cropland and pastures (Homer, 2007). Several run-of-river dams on the mainstem Mississippi exist for hydropower and navigation. While these dams have little impact on the overall quantity of flow on the river (USACE, 2004) the gate operations have generated rapid change in river water surface (MnDNR, 2004). The U.S. Army Corps of Engineers operates six large reservoirs in the upper headwaters for purposes of mainstem navigation and specific tributary minimum flows (33 CFR 207.340; USACE, 2012). Table A2-3 lists the USACE reservoirs and storage information. The first five of these reservoirs were constructed between 1884 and 1895. The original dam structures were timber and earth construction; the dams were reconstructed as concrete structures between 1900 and 1912. The final system reservoir was constructed in 1912. Total capacity of the system dams is around 1.7 million acre-feet.

The drainage area to the Minnesota River at Fort Snelling State Park watershed covers 16,907 square miles. The majority of this drainage area is predominately cultivated cropland. The lower portion of the basin is a mixture of cultivated cropland, pastures, deciduous forests, and developed lands. Below the confluence, the mostly urban drainage area contributes an additional 44 square miles.

Figure A2-1 shows the respective drainage areas and key reservoirs.

**Table A2-3. Upper Mississippi River U.S. Army Corps of Engineers Reservoirs**

<b>Dam</b>	<b>Original Construction Date</b>	<b>Rebuilt Construction Date</b>	<b>Drainage Area (mi<sup>2</sup>)</b>	<b>Average Storage (acft)</b>	<b>Maximum Storage (acft)</b>
Winnibigoshish Lake	1884	1900	1,442	220,000	550,000
Leech Lake	1884	1903	1,163	490,000	680,000
Pohegama	1885	1904	660	82,000	120,000
Pine River	1886	1907	562	101,340	187,700
Sandy Lake	1895	1912	421	37,500	72,500

### **Mississippi River Drainage Areas**

#### **PAST STUDIES**

Previous water supply studies relevant to the study area or associated river watersheds were reviewed. These studies included:

- Fairbairn (2011) summarizes approaches for evaluating water supply, examples of Minnesota watershed water budgets, and past water supply studies.
- Minnesota Department of Natural Resources (2000) describes trends in water uses, variability and distribution of supply sources, and approaches for sustainable management and regulation.
- The U.S. Geological Survey (2010), in cooperation with the Council, evaluated low flow conditions and associated probabilities on the Mississippi River in the reach near Anoka, MN.

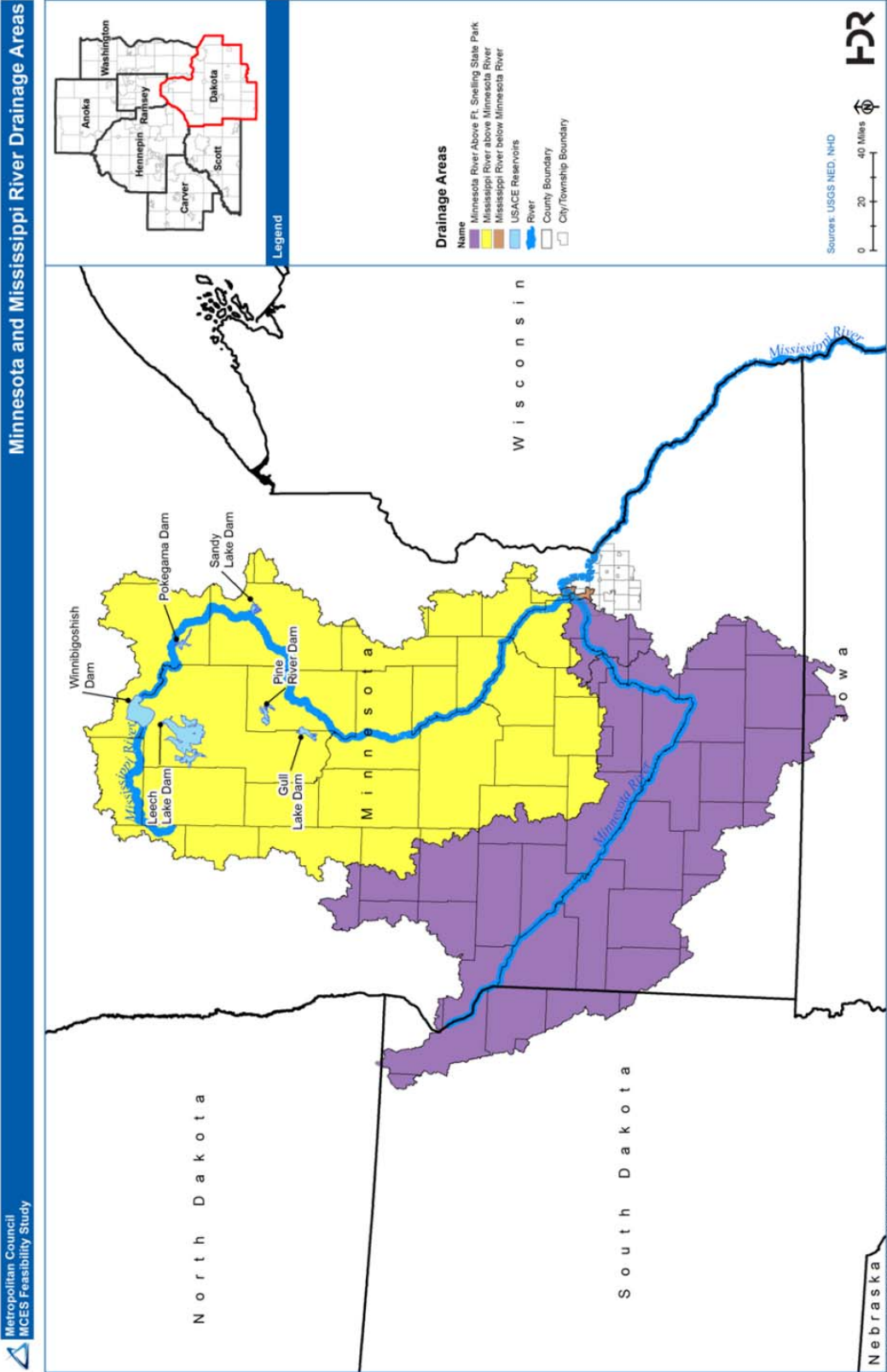


Figure A2-1. Mississippi River Drainage Areas

## **METHODOLOGY**

The availability of surface water at both potential diversion locations (Minnesota River and the Mississippi River downstream of the Minnesota River confluence) was evaluated based on the past climatic variability. Historic droughts were identified and evaluated based on duration and severity. Droughts that were more stressing to available river flows were further evaluated using gage flow data. Locations which lacked flow data were estimated using regional references gages and statistical relationships. These historic measured or estimated low flows were adjusted based on minimum flow scenarios, providing a range of available surface water supply. Details on minimum flow scenarios are described in the section “Minimum Flow Standards” in this appendix. When compared to study area demand scenarios, the potential shortages of each supply source and frequency of shortages were determined.

## **HISTORIC DROUGHT**

The evaluation of surface water availability includes an assessment of historic climatic variability from years 1907 to 2012. Drought frequency, duration and severity are used to quantify historic drought.

## **DROUGHT DEFINITIONS**

Droughts are ultimately defined by hydrologic and environmental impacts driven by a lack of precipitation. The extent in quantity and length in time of the deviation of precipitation from normal levels affects when a drought is thought to begin, end, and its severity. The characterization of drought is formed in several stages which relate duration and extent of precipitation from normal and the severity of the lack of precipitation on water resources (Gregg, 1996). An initial reduction in precipitation is referred to as a “meteorological drought”. A meteorological drought can occur without immediately impacting streamflow, groundwater storage, lakes, and other water resource features.

As the meteorological drought continues, soil moisture becomes depleted. Evaporation is continually taking place from soil. Some of this evaporation is generated as plants take in moisture through roots and transpire through leaves. This process, called “evapotranspiration”, is critical to keep plants alive and growing. As soil moisture becomes depleted due to lack of rainfall plus continuing extraction, the drought can be seen to continue and worsen. This impact to soil moisture and ultimately plant productivity is an “agricultural drought”.

Further worsening of drought conditions affect other water resource features typically used for water supply. Reduced runoff and infiltration into the aquifer will correspondingly reduce stream flows, lowered lake levels, and reduction in aquifer storage. Once groundwater and surface waters are significantly impacted by a lack of precipitation, a “hydrologic drought” occurs. A minor drought may affect small streams, causing low flows or drying. A major drought could impact surface storage, lakes and reservoirs, affecting water quality and causing municipal and agricultural water supply problems. Aquifer declines can range from a quick response (shallow sand) to impacts forming over multiple drought years.



The final type of drought refers to the economic and social impacts of drought. A “socioeconomic drought” can occur during any of the previously described drought types as it refers to the impacts that deficits of precipitation might have on agricultural, industrial, commercial, municipal, and other sectors producing an economic good. The socioeconomic impacts also include impacts to lifestyles and living conditions. Figure A2-2 shows drought in the hydrologic cycle. The various horizontal curves hypothetically show some measure of drought throughout the hydrologic cycle, over time. The dashed line traces the impacts that a reduction in precipitation causes over the hydrologic cycle.

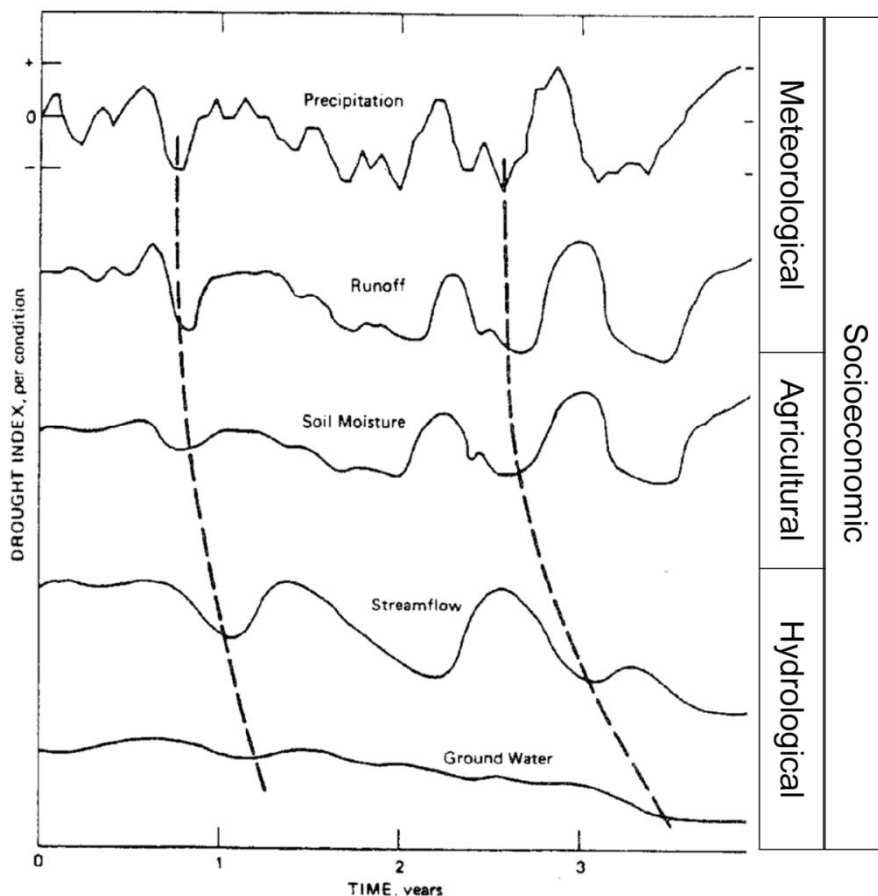


Figure A2-2. Effects of Drought over the Water Cycle (after Changnon, 1987)

#### DROUGHT INDICES

Quantifying droughts is useful for determining the beginning, duration, and overall severity of each drought event. This quantification is complicated by the forms of drought can take (e.g., meteorological, agricultural, and so forth) and that drought conditions and impacts can vary over a watershed. A drought index is a numerical indicator that provides a measure of drought severity over time. A variety of drought indices are available, many of which are summarized by Hayes (Hayes, 2002). A general drought index will focus on an implied or explicit time frame of reduced precipitation.

That is, it may measure a short time frame (tracking emergence of meteorological or agricultural drought of interest to stakeholders such as farmers or habitat managers) or a longer time frame (tracking the emergence of hydrologic drought, of interest to stakeholders such as water supply managers). Additionally, a drought index will strive to be applicable over a large watershed. For this document, two drought indices pertinent to hydrologic drought are discussed: the Modified Palmer Drought Index (PMDI) and the Standard Precipitation Index (SPI).

The Palmer Drought Severity Index (PDSI) was developed by Palmer (1965) and later revised as the Modified Palmer Drought Index (PMDI). The PMDI is not explicitly tied to a specific timeframe for measuring drought. However, it tracks watershed soil moisture and thus tends to reflect agricultural and hydrologic droughts conditions. An estimate of the capacity of watershed soils to retain moisture is referred to as the Available Water Holding Capacity (AWHC). Rainfall infiltrates into the soil and is held in the soil pores. Plants remove moisture through evapotranspiration. Under normal conditions, the rainfall is sufficient to keep an adequate amount of moisture in the soil for plant needs. As drought develops, the soil moisture is reduced as rainfall cannot keep the soil recharged as depletions occur with evapotranspiration. The PMDI provides a number which classifies the drought severity as a measure of soil moisture deficit, with extreme drought having a greater potential impact on plants. Numerical values of the PMDI index are:

- -4 or less: Extreme drought
- -3 to -4: Severe drought
- -2 to -3: Moderate drought
- -1 to -2: Mild drought
- -0.5 to -1: Incipient dry spell
- +0.5 to -0.5: Near normal
- +0.5 to +0.9: Incipient wet spell
- +1 to +2: Slightly wet
- +2 to +3: Moderately wet
- +3 to +4: Very wet
- +4 or greater: Extremely wet

The Standardized Precipitation Index (SPI) is another measure of drought (McKee, 1993). While the PDSI index uses a physical characteristic of the basin (soil moisture retention) in addition to rainfall, the SPI index only incorporates rainfall. The cumulative rainfall received in a given timeframe is compared to the amount of rainfall received in past years. The statistical deficit is then converted into a numerical score which determines the severity of drought. SPI can be computed for various timeframes, such as a 3-month SPI which uses cumulative rainfall over 3 months or a 12-month SPI which looks at the last year. A short term length SPI might be an index for meteorological or agricultural drought while a longer time length SPI might measure hydrologic drought. SPI values are:

- -2 or less: Extremely dry
- -1.5 to -2: Severely dry
- -1 to -1.5: Moderately dry

- +1 to -1: Near normal
- +1 to +1.5: Moderately wet
- +1.5 to +2: Very wet
- +2 or more: Extremely wet

#### **SOURCES OF HISTORIC DROUGHT INFORMATION**

The National Oceanic and Atmospheric Administration (NOAA) provides estimates of past temperature, precipitation, and various drought indices (NOAA, 2007). The estimates are averaged over defined climate regions or zones, which divide the state into sections. For this document, the following climate regions are relevant:

- Minnesota NOAA Region 4: West Central, covering the headwaters region of the Minnesota River
- Minnesota NOAA Region 5: Central, central portion of the Minnesota and Mississippi River drainage area
- Minnesota NOAA Region 6: East Central, including the metro area

Historic and reconstructed drought indices provided by NOAA range from January 1895 to February 2014. The monthly average flows at the USGS Mississippi River at Saint Paul stream measurement location were correlated against the PMDI index and various duration SPI indices. Both the PMDI and the 9-month to 12-month SPI indices had a high correlation to overall monthly stream flows, ranging from  $R^2=0.81$  to 0.85 respectively. Thus, both of these indices appear to be a relevant measure of drought affecting surface water supply.

Chart A2-1 plots the PMDI index for the central climate region (Minnesota NOAA Region 5). Table A2-4 organizes the drought events, generally determined to start when the index becomes consistently negative in value and ending after the index sustains a positive value. While there is some interpretation on when certain small drought events might begin or end, there are about 29 drought events measured in the past 118 years. The median drought lasted about 1.5 years and is moderate in overall severity.

The general trend is that the more recent timeframe has been normal to wet conditions, with an interspersed year or two of drought ranging from mild to severe drought. An extreme drought occurred from approximately 1987 to 1990, lasting around 40 consecutive months. The timeframe of 1974 to 1977 was also an extreme drought. The late 1940s to early 1970 had increasing occurrence of generally mild to moderate droughts. Extreme droughts occurred more frequently prior to 1940. The longest drought of record occurred from around 1930 to 1940, approximately 120 months of consecutive drought, and was characterized as an extreme drought. The period from 1920 to 1926, approximately 70 months, and 1910 to 1913, 40 months, were also an extreme drought.

Historic Modified Palmer Drought Severity Index Minnesota NOAA Region 5 (Central)  
January 1895 to February 2014

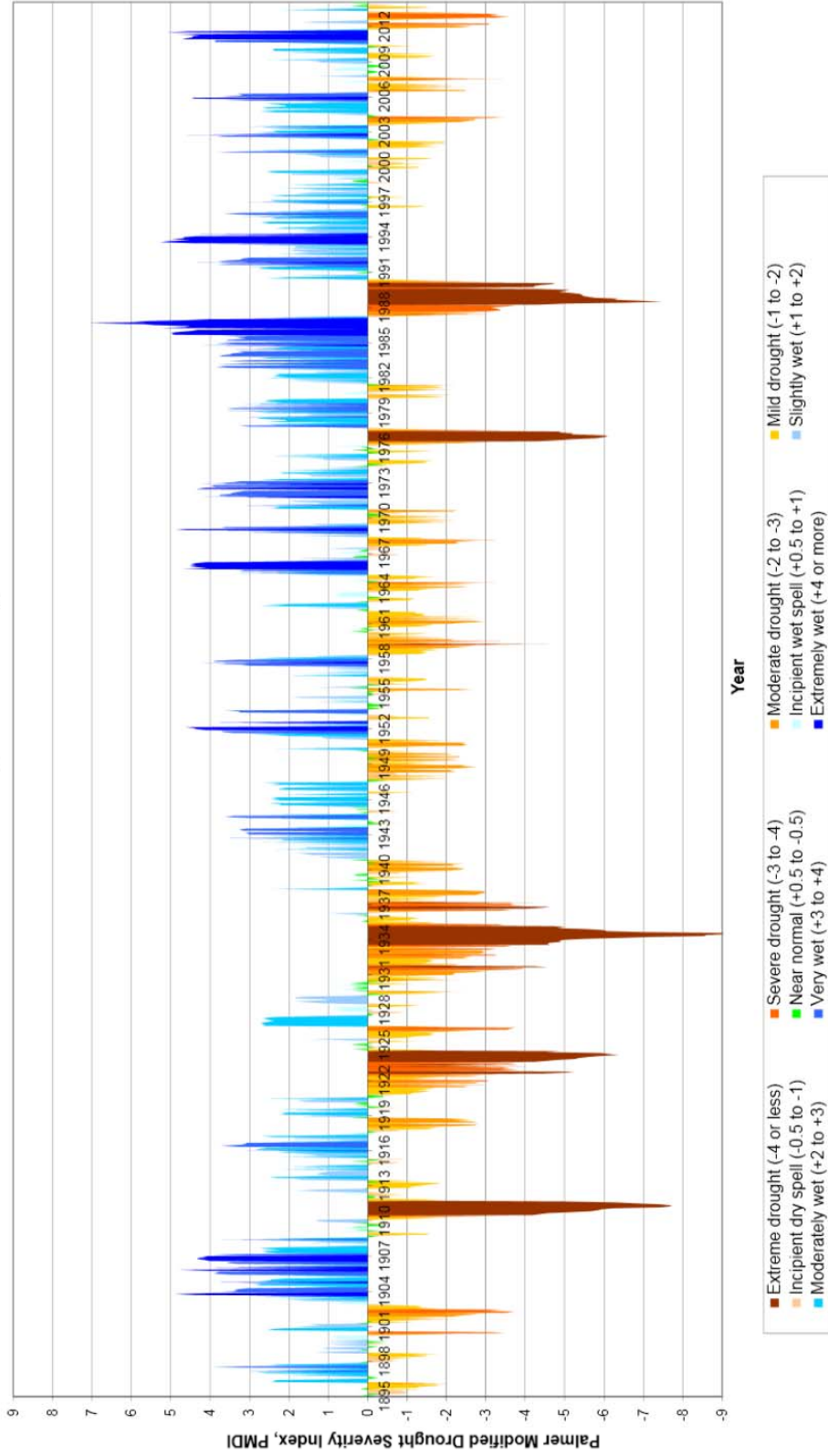


Chart A2-3. Historic Modified Palmer Drought Severity Index

**Table A2-4. Summary of Regional Droughts**

<b>Drought Years</b>	<b>Duration (months)</b>	<b>Maximum Severity (PMDI)</b>
1895-1896	12	Moderate
1898	9	Mild
1900	5	Severe
1901-1902	19	Severe
1908	4	Mild
1910-1913	40	Extreme
1917-1918	14	Moderate
1920-1926	71	Extreme
1928	3	Mild
1929	3	Moderate
1930-1940	124	Extreme
1947-1951	42	Moderate
1952-1953	5	Mild
1955-1956	18	Moderate
1958-1962	45	Extreme
1962-1965	27	Severe
1966-1968	19	Severe
1969-1970	14	Moderate
1974-1977	39	Extreme
1980-1981	14	Moderate

<b>Drought Years</b>	<b>Duration (months)</b>	<b>Maximum Severity (PMDI)</b>
1987-1990	38	Extreme
1996	2	Mild
1997	1	Mild
1999-2000	12	Mild
2001-2002	9	Moderate
2003-2004	9	Severe
2006-2007	16	Severe
2009	5	Mild
2011-2013	18	Severe

**THE 1987 TO 1990 DROUGHT**

After the dry year of 1988, the Minnesota Department of Natural Resources compiled issues and actions undertaken in response to drought impacts (MnDNR, 1989). Some communities had sought out replacements for shallow wells, expansion of existing surface water storage, and pursued interconnections with regional water supply utilities. Water quality was a concern on the Mississippi River below the metropolitan wastewater treatment plant due to the low flows. Dissolved oxygen concentrations, with a minimum target of 5 mg/l, at times fell to 3 to 4 mg/l.

The drought year illustrated the need for alternative water supplies for the Minneapolis-St. Paul metropolitan area. The MnDNR notes:

"Restrictions on nonessential uses were instituted [Minneapolis-St. Paul metropolitan] area wide. Restrictions were partly due to the distribution systems not being able to handle the demand and also due to low flow on the Mississippi River. Especially in the metropolitan area, the drought dramatically demonstrated the continuing need for conservation measures to reduce water demand and also the need for alternative water supplies."

The potential use of the USACE headwater reservoir system was explored for supplemental supplies. The USACE evaluated this possibility in a 1982 feasibility study and concluded that providing 1,600 cfs minimum flows at the Mississippi River near Anoka could be possible. The releases would require stakeholder coordination and agreement that would include the Leech Lake tribe and Mississippi Headwaters Association.

However, the reservoirs were authorized for navigation purposes and not water supply or other needs. Supplemental water supply releases from the headwaters reservoirs was requested by the State of Minnesota during 1988 although only prescribed navigation operations specified in the USACE water management plan were performed.

#### **HISTORIC STREAM FLOWS**

Historic drought indices indicate that droughts of record occurred from 1930 to 1940 and also from 1920 to 1926. These droughts lasted between 70 and 120 months, respectively, and were characterized as extreme drought events. An equally severe, although shorter, drought recently occurred from 1987 to 1990. Critically dry years during these extreme droughts will determine the potential for additional or conjunctive surface water supply for the study area. For this feasibility study, a historic stream flow reconstruction technique was used to estimate monthly average stream flows on the Minnesota River near Fort Snelling Park and also the Mississippi River at Saint Paul. In addition to the 1930s extreme drought, the reconstruction attempted to examine the 1920s drought as well.

#### **AVAILABLE STREAMFLOW DATA**

Data from the USGS stream gaging sites located within the Mississippi and Minnesota watershed areas were compiled.

Table A2-5 below provides select gage sites. The USGS Gage 05330920, Minnesota River at Fort Snelling State Park (“Fort Snelling Gage”), is the reference gage for use in estimating historic surface water for potential surface water supply from the Minnesota River to the study area. Downstream of the confluence with the Minnesota River, USGS Gage 05331000 Mississippi River at Saint Paul (“Saint Paul Gage”) is used as the reference site for potential surface water deliveries to the study area.

The Saint Paul gage has a long history of operation, beginning in March of 1892. The winter months between 1892 and 1906 were often not measured. A complete period of record is available at this site beginning on April 1906 and onward, which covers the critical droughts being considered. The Fort Snelling gage has a relative short period of record, the site having been established in January of 2004. Correlations and statistical relationships between these gages and other watershed reference gages were considered to fill and extend the period of record of the Fort Snelling gage. These reference gages include upstream sites on the Minnesota and Mississippi Rivers, also shown in Table A-25.

**Table A2-5. Period of Record for Select Reference Stream Gages**

<b>USGS Gage ID</b>	<b>Name</b>	<b>Reviewed Period of Record</b>
05267000	Mississippi River near Royalton, MN	April 1924 to 2013
05275500	Mississippi River at Elk River, MN	August 1915 to October 1956
05288500	Mississippi River near Anoka, MN	June 1931 to 2013
05325000	Minnesota River at Mankato, MN	June 1903 to 2013 <sup>1</sup>
05330000	Minnesota River near Jordan, MN	October 1934 to 2013
05330920	Minnesota River at Fort Snelling State Park, MN	January 2004 to 2013
05331000	Mississippi River at St. Paul, MN	March 1892 to November 1899 <sup>1</sup> April 1900 to November 1905 April 1906 to 2013

Notes:

<sup>1</sup> Gage may not be operable during winter months.

**FILLING AND EXTENSION OF MISSING STREAM FLOW DATA**

Of the two key stream gages, the Mississippi River at St. Paul (05331000) has a long period of record that covers the critical drought events. The Minnesota River at Fort Snelling State Park (05330920), in contrast, has relatively recent data. The next gage upstream on the Minnesota River (05330000 near Jordan) has records that extend back to the 1930's but was not operated prior to 1934.

To extend the Minnesota River at Fort Snelling reference stream gage, a statistical technique was applied. The approach, the Maintenance of Variance Extension (or "MOVE" technique), is similar to linear regression (Hirsch, 1982). Two stream gages are compared over a common period of record, when both sites were operating. A correlation between the two sites was computed which provides a measure of degree that each gage is a predictor of flows at the other gage. High correlation pairings were then used to develop an "organic line of correlation" based on the statistical averages and standard deviations of each gage over the common period of record. Using this relationship, one of the gage pairs can be used to estimate flow at the other site at times when that site was not operational.

Table A2-6 lists the gage pairings developed using the reference gages. Monthly average flows were used in computing the correlation and organic line of correlation. Monthly averages smooth out any local variations that may occur if a particularly intense storm is located in a portion of the basin. The monthly averages also smooth out travel time differences between gage locations.



**Table A2-6. Equations for Estimating Missing Stream Flow Data**

USGS Stream Gage		Common Period of Record [months]	Monthly Correlation (R <sup>2</sup> )	Monthly Filling Equation
Gage with Missing Data (Y)	Gage with Available Data (X)			
05331000	05325000	1,263	0.92	$Y=X*2.23+4373$
05330000	05331000	949	0.94	$Y=X*0.50-2117$
05330000	05325000	949	0.99	$Y=X*1.10+172$
05330920	05330000	117	0.99	$Y=X*1.05+108$
05330920	05325000	117	0.98	$Y=X*1.16+271$
05330920	05331000	117	0.95	$Y=X*0.56-1788$
05288500	05275500	305	0.99	$Y=X*1.28-370$
05288500	05267000	990	0.96	$Y=X*1.76-510$
05288500	05331000	989	0.94	$Y=X*0.52+1417$

**HISTORIC AND ESTIMATED STREAM FLOW DATA**

Multiple gage locations were examined, as shown in Table A2-6. After review of the potential filled period of record, a smaller set of gages were selected based on the length of the period of record and correlations. For estimation of flows at the Minnesota River at Fort Snelling State Park, three reference gage pairings were examined. The nearest upstream gage of the Minnesota River near Jordan (05330000) has a correlation coefficient (R<sup>2</sup>) of 0.99; further upstream on the Minnesota River, the Minnesota River at Mankato (05325000) had a correlation of 0.98. The Mississippi River at St. Paul (05331000), downstream of the confluence with the Minnesota River had a correlation of 0.95. The gage extension was filled in order of correlation coefficient. For example if data existed for the Minnesota River near Jordan gage at a particular time, that relationship was used to estimate the Minnesota River at Fort Snelling State Park. If the Jordan gage was not available, then the Mankato gage was used. If neither of the Minnesota River reference gages were available, the Mississippi River at St. Paul gage was used to estimate the Fort Snelling gage flow. In some cases, use of the St. Paul gage could result in negative flows calculated at Fort Snelling during drought events. Without additional information or analysis (such as a low-flow calibrated rainfall-runoff model or water budgets), negative flows were set to the minimum positive flow calculated at Fort Snelling of 111 cfs. This latter flow is the minimum that was observed at the gage during its operational period of record.

The extended period of record for both sites was 1901 to 2012, with part of year 1906 missing. Chart A2-2 and Chart A2-3 provide and annual runoff volume for both sites. Table A2-7 lists the median flows and volumes and other statistics calculated over the extended period of record. The average monthly low flow for all months was 620 cfs in January for Fort Snelling. For the St. Paul site, the minimum monthly flow for all months is 4,048 cfs in February. Over a median year the St. Paul gage, located downstream of the confluence with the Minnesota, has 2.8 times more flow than the Fort Snelling gage. During low-flow months, the St. Paul gage ranges from 5.5 to 6.8 times more flow than the Fort Snelling gage.

Table A2-8 and Table A2-9 provide flow volume and minimum monthly flows either measured (for the St. Paul gage) or estimated (the Fort Snelling gage) for drought events. Both tables are ordered from lowest to highest annual runoff for drought events. The 1930s drought event has historically lower runoff than the other drought events considered. At the St. Paul gage the lowest annual runoff of the drought event, occurring in 1934, was approximately 1.4 million acre-feet or 15% of average. This is in contrast to other drought events, which ranged from 35% to 40% of average. The minimum monthly flow for the Mississippi River at St Paul site for the 1930s drought occurred in August 1934 and was 864 cfs, which was 12% of average for this month. Mostly this contrasts with other drought events where the lowest monthly runoff occurs in winter rather than summer. The 1987 to 1990 drought event has a minimum monthly flow in summer (July) as well.

The 1934 annual runoff at the Fort Snelling gage was estimated at around 300,000 acre-feet, or 9% of average. Other drought events at this location ranged from 15% to 30% of average annual runoff. The drought event with the lowest minimum monthly flow was in January 1923 with an estimated flow of around 100 cfs. The minimum monthly flow generally appears to occur in winter months; the 1987 to 1990 event is the exception with a summer (September) lowest minimum monthly flow. The average monthly flows for the selected drought years are shown in Chart A2-4 and Chart A2-5 for the Fort Snelling and St. Paul gage sites, respectively.

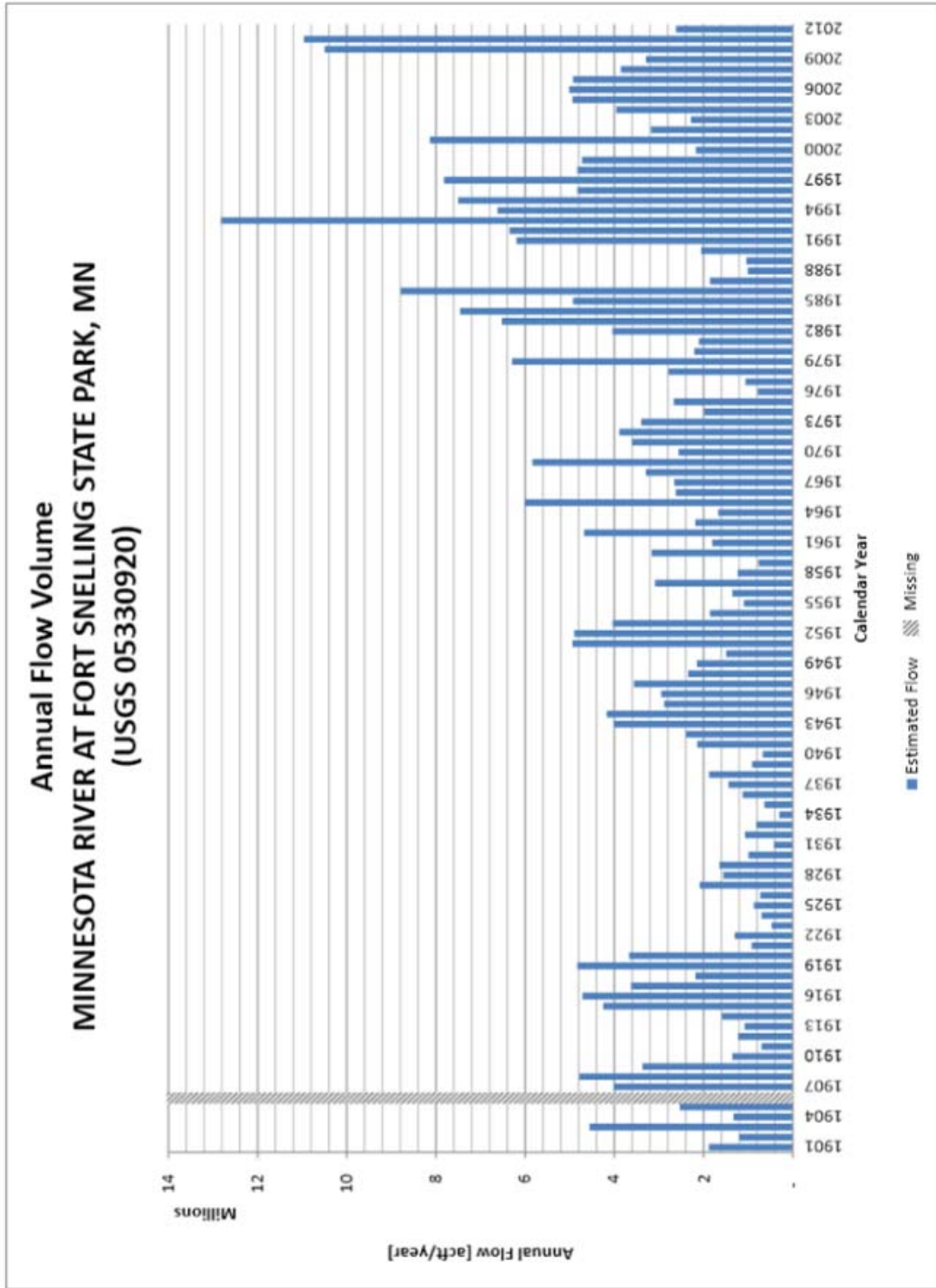


Chart A2-2. Historic and Estimated Annual Flows at Fort Snelling Gage

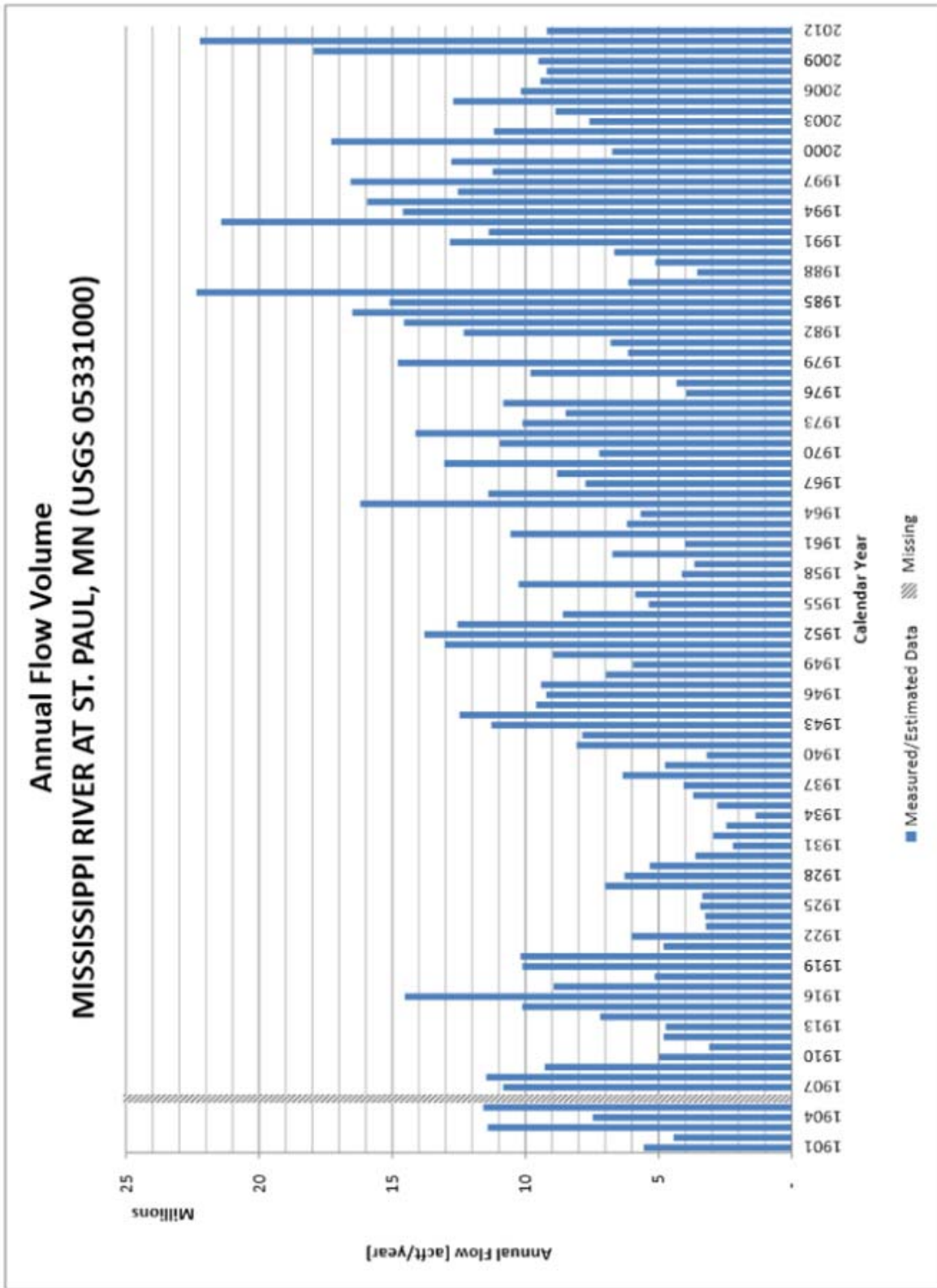


Chart A2-3. Historic and Estimated Annual Flows at St. Paul Gage

**Table A2-7. Stream Gage Flow Statistics for Reconstructed Period of Record (1901-2012)**

Time	Median Flow or Volume	
	Minnesota River at Fort Snelling State Park (05330920)	Mississippi River at St. Paul (05331000)
January	620 cfs	4,217 cfs
February	708 cfs	4,048 cfs
March	3,614 cfs	8,965 cfs
April	7,538 cfs	23,613 cfs
May	5,694 cfs	19,000 cfs
June	6,617 cfs	17,400 cfs
July	4,373 cfs	12,171 cfs
August	1,889 cfs	6,974 cfs
September	1,402 cfs	6,172 cfs
October	1,251 cfs	6,915 cfs
November	1,208 cfs	6,640 cfs
December	851 cfs	4,700 cfs
Annual	3,218,641 acft	8,873,788 acft
90% Annual Exceedance	439 cfs	3,002 cfs

Note:

<sup>1</sup> cfs is equal to 1.9835 acre-feet per day.

**Table A2-8. Select Drought Year Statistics for Modified Minnesota River at Fort Snelling Gage**

Select Drought Year	Annual Volume [acft/yr] (Percent of Average)	Minimum Monthly Average Flow [cfs] (Percent of Average)	Month of Minimum Flow
1934	297,833 (9%)	284 (23%)	October
1923	476,522 (15%)	111 <sup>1</sup> (18%)	January
1911	697,570 (22%)	475 (77%)	January
1959	766,961 (24%)	316 (45%)	February
1988	1,008,788 (31%)	367 (26%)	September

**Notes:**

<sup>1</sup> Minimum monthly flow was calculated as a negative number. The flow was set to the minimum positive flow in the measured period of record.

**Table A2-9. Select Drought Year Statistics for Modified Mississippi River at St. Paul Gage**

Select Drought Year	Annual Volume [acft/yr] (Percent of Average)	Minimum Monthly Average Flow [cfs] (Percent of Average)	Month of Minimum Flow
1934	1,360,657 (15%)	864 (12%)	August
1911	3,103,880 (35%)	1,960 (46%)	January
1923	3,229,396 (36%)	2,504 (62%)	February
1988	3,549,592 (40%)	1,363 (11%)	July
1959	3,659,756 (41%)	1,770 (44%)	February

**Average Monthly Flows for Select Drought Years  
MINNESOTA RIVER AT FORT SNELLING STATE PARK, MN  
(USGS 05330920)**

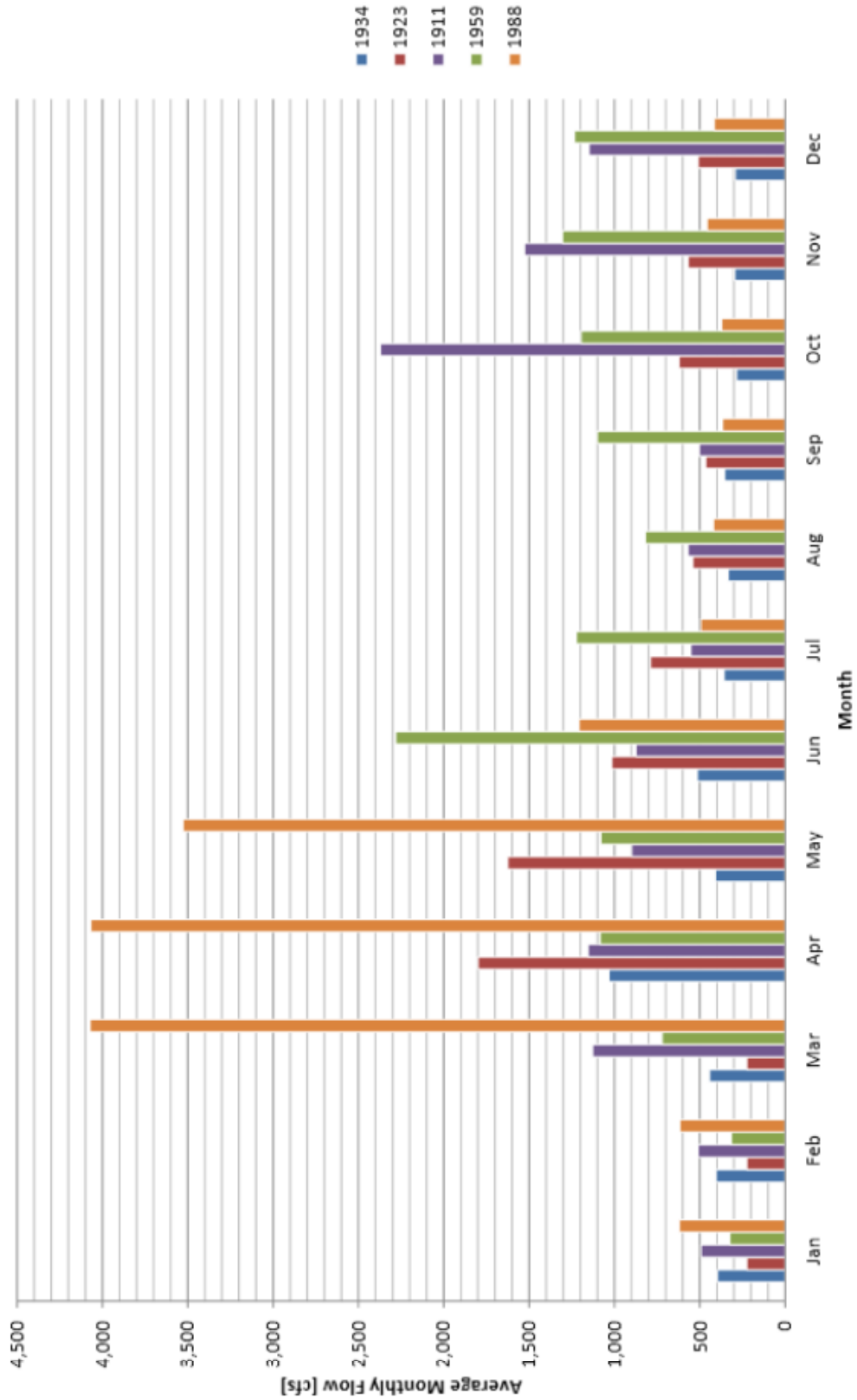


Chart A2-4. Average Monthly Flow for Select Drought Years at Fort Snelling Gage

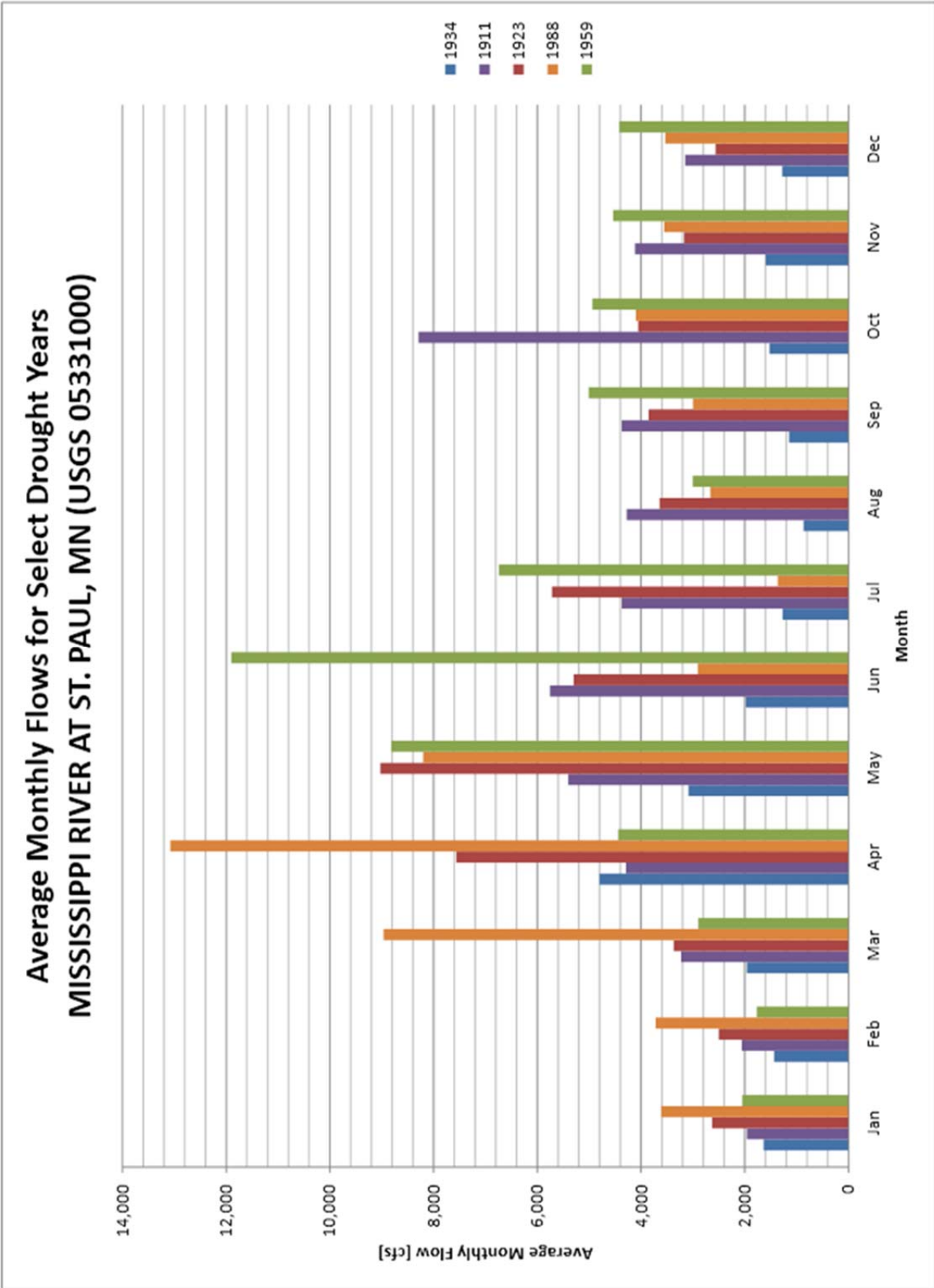


Chart A2-5. Average Monthly Flow for Select Drought Years at St. Paul Gage



#### **AVAILABLE SUPPLY AND POTENTIAL SHORTAGES FOR SURFACE WATER**

The availability of supply was evaluated by comparing the historic or estimated monthly river flows to the estimated future demands. As discussed previously, a hydrologic analysis was conducted to estimate potential water available at two representative surface water diversion locations, the Fort Snelling gage site on the Minnesota River and the St. Paul gage site on the Mississippi River, based on historical stream flow records. Additionally, assumptions of minimum stream flows at each potential diversion site are considered.

#### **ANNUAL AND MONTHLY DEMAND SCENARIOS**

Demand amounts for current (Year 2010) and projected Year 2040 water use scenarios were provided by the Council. The annual demand scenarios were converted into average monthly demands for comparison with seasonal surface water availability. Monthly groundwater pumping data reported for the communities of Apple Valley, Burnsville, Farmington, and Rosemount was compiled for calendar years 2005 to 2013 to create a composite representation of typical demand patterns for the study area. The average monthly pumping was calculated over this timeframe and then expressed as a percentage of the annual total. Winter months represent approximately 5% to 6% of the total annual demand for each month. The peak pumping month is July, where about 15% of the annual total is withdrawn.

Table A2-10 provides the monthly and annual withdrawals for the Current (Year 2010) and projected Year 2040 demand scenarios. Winter demands in the current (Year 2010) scenario average about 920 million of gallons, or 46 cfs, per month in January and peak to 2.5 billion gallons, or 123 cfs, per month in July. For the Year 2040 demand scenario, winter demands increase to about 0.9 to 1.0 billion gallons, or 50 cfs, per month in January and peak at 2.7 billion gallons, or 136 cfs, in July.

**Table A2-10. Average Monthly Service Area Demands**

<b>Time</b>	<b>Demand [Percent of Annual Total]</b>	<b>Current (Year 2010) Demand [Million gallons] (cfs)</b>	<b>Year 2040 Demand [Million gallons] (cfs)</b>
January	5.6%	916 (46 cfs)	1,012 (51 cfs)
February	5.1%	826 (46 cfs)	913 (50 cfs)
March	5.3%	861 (43 cfs)	951 (47 cfs)
April	6.0%	967 (50 cfs)	1,068 (55 cfs)
May	8.8%	1,421 (71 cfs)	1,570 (78 cfs)
June	11.3%	1,844 (95 cfs)	2,036 (105 cfs)
July	15.2%	2,465 (123 cfs)	2,723 (136 cfs)
August	13.3%	2,153 (107 cfs)	2,378 (119 cfs)
September	11.0%	1,791 (92 cfs)	1,978 (102 cfs)
October	7.5%	1,214 (61 cfs)	1,341 (67 cfs)
November	5.2%	852 (44 cfs)	941 (49 cfs)
December	5.7%	920 (46 cfs)	1,016 (51 cfs)
Annual	100%	16,230 MGY (44.8 MGD)	17,927 (49.1 MGD)

**MINIMUM FLOW STANDARDS**

Minnesota water law will limit or prevent consumptive water uses from surface water sources based on a set minimum in-stream flow. The minimum in-stream flow is intended to protect river and habitat uses including fisheries, riparian habitat, navigation, and recreation. The minimum flows may be determined from a detailed study, but most often are based on a statistic of flows passing a gage site 90% of the time (also known as Q<sub>90</sub>). By definition, the Q<sub>90</sub> minimum flow target means at least 10% of the time there will be potential restrictions on water allocations.

There are potential avenues where a surface water diversion on the Minnesota or Mississippi river systems would not be curtailed, or at least have reduced reduction in withdrawals. Curtailment of water use in low flow situations is driven by the consumptive use, which is defined as the difference between a withdrawal of water and the return flows to the same water source. Programs which reduce consumptive use, such as cessation of outdoor irrigation, could allow non-consumptive uses to remain unaffected provided there is limited impact on reaches between the point of diversion and point of return flows.

Secondly, Minnesota water law defines a hierarchical list of water uses. Lower priority water uses are subject to curtailment prior to higher priority uses. Diversions serving domestic water supply have one of the highest priority uses. The priority water uses are:

- First priority: Domestic water supply and essential power production, as defined in contingency plans. Industrial and commercial water uses supplied by a municipal water supply are excluded from this priority.
- Second priority: Any allocation with consumption of less than 10,000 gallons per day.
- Third priority: Agricultural irrigation and associated production, not to exceed consumption of 10,000 gallons per day.
- Fourth priority: Power production in excess of the defined essential production levels.
- Fifth priority: Agricultural water use which exceeds 10,000 gallons per day.
- Sixth priority: All other uses.

Lastly, Minnesota water law allows the possibility of watershed shortage regulation through a coordinated allocation plan. An allocation plan has components which include:

- Develop a stakeholder group of all water users in the basin to develop the plan.
- Address the minimum flow and resource requirements.
- Assess actual water use and needs if these differ from the permitted amounts.
- Develop water sharing approaches to resolve or reduce water use conflicts.
- Maintain monitoring to determine when water supply is above the minimum resource requirement and available for allocation.

While not an allocation plan meeting these criteria, a loose operating agreement was developed amongst mainstem Mississippi water users and hydropower facilities (MnDNR, 2004). During the 1987 to 1990 drought, operation of run-of-river hydropower facilities could produce daily surges in the river flow. The operating agreement reached is triggered when Mississippi River flows at Anoka fall below the  $Q_{90}$  threshold, with the goal of coordinating and smoothing river flows.

Two minimum flow scenarios were examined in conjunction with this surface water availability analysis. One scenario assumes consumptive water use is reduced and the high priority for domestic supply allows for no legal restrictions on the amount withdrawn from the surface water diversion. In other words, nearly the full amount of water withdrawn is returned via a wastewater treatment plant closely situated to the withdrawal location.

In the second minimum flow scenario, the  $Q_{90}$  flow at each potential surface water diversion site is the minimum flow target and any surface water diversion is assumed to be completely consumptive, at least in the river reach between the point of diversion and the waste water treatment plant. When river flows fall below the  $Q_{90}$  target, no surface water diversions are allowed. The MnDNR provides the  $Q_{90}$  flow statistic for upstream sites at the Minnesota River near Jordan and the Mississippi River near Anoka.

The  $Q_{90}$  statistic for the potential representative surface water diversion locations, the Fort Snelling and St. Paul gages, was also calculated from the estimated extended period of record. These calculated  $Q_{90}$  minimum flows are shown in Table A2-11, along with the closest official  $Q_{90}$  flows at upstream gages.

**Table A2-11. Minimum Stream Flows ( $Q_{90}$ ) at Select Gage Locations**

Location	$Q_{90}$ Flow [cfs]
05330000 - Minnesota River near Jordan	350
05330920 - Minnesota River at Fort Snelling State Park	439
05288500 - Mississippi River near Anoka	2,220
05331000 - Mississippi River at St. Paul	3,002

**Notes:**

Minnesota River near Jordan and Mississippi River near Anoka values from MnDNR (2012): Guidelines for Suspension of Surface Water Appropriation Permits. Values for the Fort Snelling and St. Paul gage calculated from extended period of record.

**MINNESOTA RIVER SURFACE WATER SUPPLY SHORTAGE ANALYSIS**

Shortage analysis for a potential representative surface water diversion on the Minnesota River was examined by taking the estimated monthly average historic flows at the Minnesota River at Fort Snelling State Park gage site and comparing to the monthly average demand scenarios. Two minimum flow scenarios were also incorporated by either assuming the full flow is available for diversion or maintaining the minimum  $Q_{90}$  flow amount prior to diversion. Under the minimum flow scenario assuming the full river flow is available for diversion, there are no calculated shortages (defined as average monthly demands exceeding the monthly average river flow). The historic month with the most constrained supply is October 1921, with river flows of 225 cfs. After diverting the monthly October demand of 1,214 MGM (61 cfs) for the Current (Year 2010) demand scenario or 1,341 MGM (67 cfs) for the Year 2040 demand scenario the remaining river flow during this minimum month is 164 cfs and 158 cfs, respectively.

When the  $Q_{90}$  flow is used as the minimum flow scenario, 52 years out of the 112 years in the historic period of record show at least one month when demands exceed the available streamflow available for diversion. Table A2-12 and Table A2-13 shows annual and maximum monthly shortages for select drought years while Chart A2-6 shows the annual shortages calculated over the period of record using the  $Q_{90}$  minimum flows and current and Year 2040 demand scenarios. The critical drought year of 1934 has an 85% annual shortage of the demand for the current (year 2010) conditions and 85% annual shortage for the Year 2040 demand scenario. The 1988 drought year shows about a 50% annual shortage for the two demand scenarios. Other representative years for other drought events have smaller annual shortages. In most cases, the month of the maximum shortage occurs in summer.

**Table A2-12. Select Drought Shortage Statistics at Fort Snelling Gage (Year 2010 Demands, Q<sub>90</sub> Minimum Flows)**

Select Drought Year	Annual Shortage [Million Gallons]	Maximum Monthly Shortage [Million Gallons]	Month of Maximum Shortage
1934	13,719	2,465	July
1923	3,948	1,254	September
1911	728	548	September
1959	1,743	916	January
1988	7,904	2,153	August

**Table A2-13. Select Drought Shortage Statistics at Fort Snelling Gage (Year 2040 Demands, Q<sub>90</sub> Minimum Flows)**

Select Drought Year	Annual Shortage [Million Gallons]	Maximum Monthly Shortage [Million Gallons]	Month of Maximum Shortage
1934	15,314	2,723	July
1923	4,632	1,441	September
1911	1,173	735	September
1959	1,925	1,012	January
1988	8,885	2,378	August

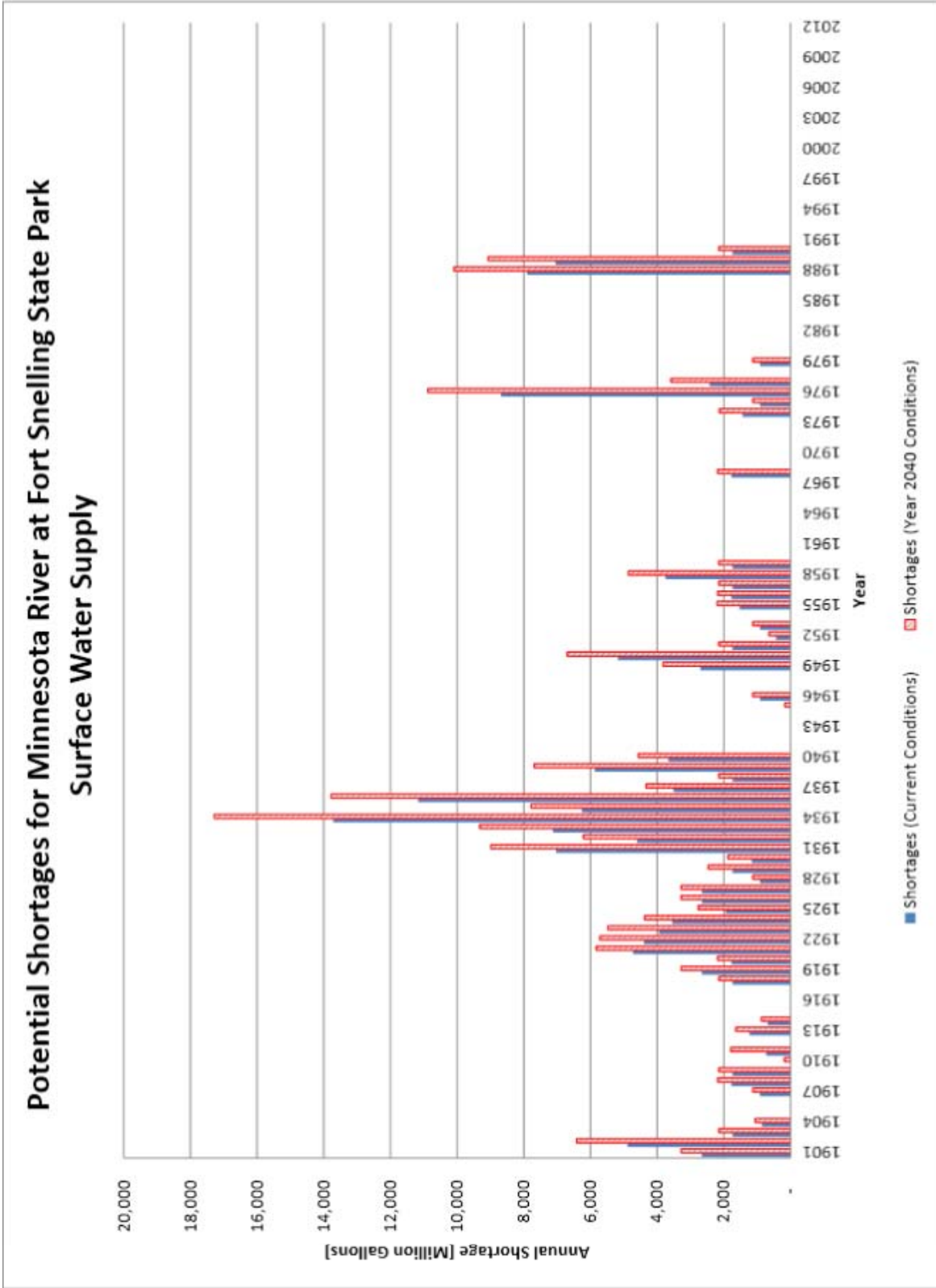


Chart A2-6. Annual Shortages at Fort Snelling Gage (Year 2010 and Year 2040 Demands, Q<sub>90</sub> Minimum Flows)

**MISSISSIPPI RIVER SURFACE WATER SUPPLY ANALYSIS**

Shortage analysis for a potential representative surface water diversion on the Mississippi River downstream of the Minnesota River confluence was examined by taking the estimated monthly average historic flows at the Mississippi River at St. Paul gage site and comparing to the monthly average demand scenarios. Two minimum flow scenarios were also incorporated by either assuming the full flow is available for diversion or protecting the Q<sub>90</sub> flow amount from diversion. Under the minimum flow scenario assuming the full river flow is available for diversion, there are no calculated shortages. The historic month with the most constrained supply is August 1934, with river flows of 864 cfs. After removing the demands of 107 cfs for the Current (Year 2010) demand scenario or 119 cfs for the Year 2040 demand scenario the remaining river flow is 756 cfs and 745 cfs, respectively.

When the Q<sub>90</sub> flow is used as the minimum flow scenario, 44 years out of the 112 years in the historic period of record show at least one month when demands exceed the available supply. Table A2-14 and Table A2-15 shows annual and maximum monthly shortages for select drought years while Chart A2-7 shows the annual shortages calculated over the period of record. The critical drought year of 1934 has an 85% annual shortage of the demand for the current (year 2010) conditions and 85% annual shortage for the Year 2040 demand scenario. The 1988 drought year shows about a 50% annual shortage for the two demand scenarios. Other representative years for other drought events have smaller annual shortages. In most cases, the month of the maximum shortage occurs in summer.

**Table A2-14. Select Drought Shortage Statistics at St. Paul Gage (Current Demands, Q<sub>90</sub> Minimum Flows)**

Select Drought Year	Annual Shortage [Million Gallons]	Maximum Monthly Shortage [Million Gallons]	Month of Maximum Shortage
1934	13,843	2,465	July
1923	2,663	920	January
1911	2,663	920	January
1959	5,626	2,103	August
1988	8,253	2,465	July

**Table A2-15. Select Drought Shortage Statistics at St. Paul Gage (Year 2040 Demands, Q<sub>90</sub> Minimum Flows)**

<b>Select Drought Year</b>	<b>Annual Shortage [Million Gallons]</b>	<b>Maximum Monthly Shortage [Million Gallons]</b>	<b>Month of Maximum Shortage</b>
1934	13,843	2,465	July
1923	2,663	920	January
1911	2,663	920	January
1959	5,626	2,103	August
1988	8,253	2,465	July



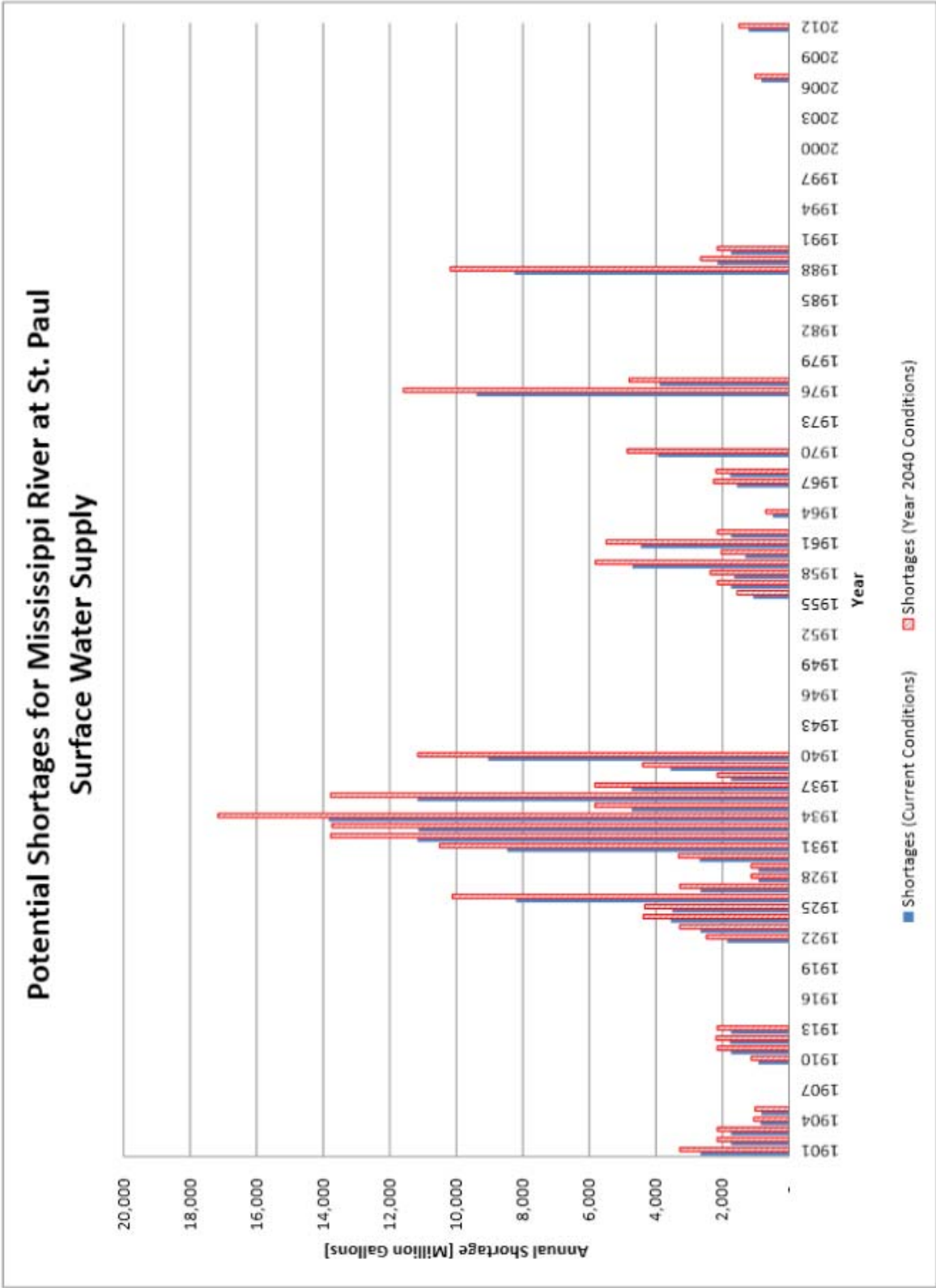


Chart A2-7. Annual Shortages at St. Paul Gage (Current and Year 2040 Demands, Q<sub>90</sub> Minimum Flows)

#### **ADDITIONAL CONSIDERATIONS AFFECTING SURFACE WATER AVAILABILITY**

In the approach used for assessment of surface water supply availability, historic streamflow was developed as a measure of historic climate variability however this method does not address future climate uncertainty, changes in consumptive water use patterns, timing and diversion constraints, or droughts of greater severity than those that occurred historically since 1907. Additional considerations and future refinement of the surface water supply analysis is prudent to evaluate the impacts of uncertainty on streamflow availability. Such refinement reduces the uncertainty of the possible climate variability and as well as clarification of legal and physical aspects needed for accessing a surface water supply.

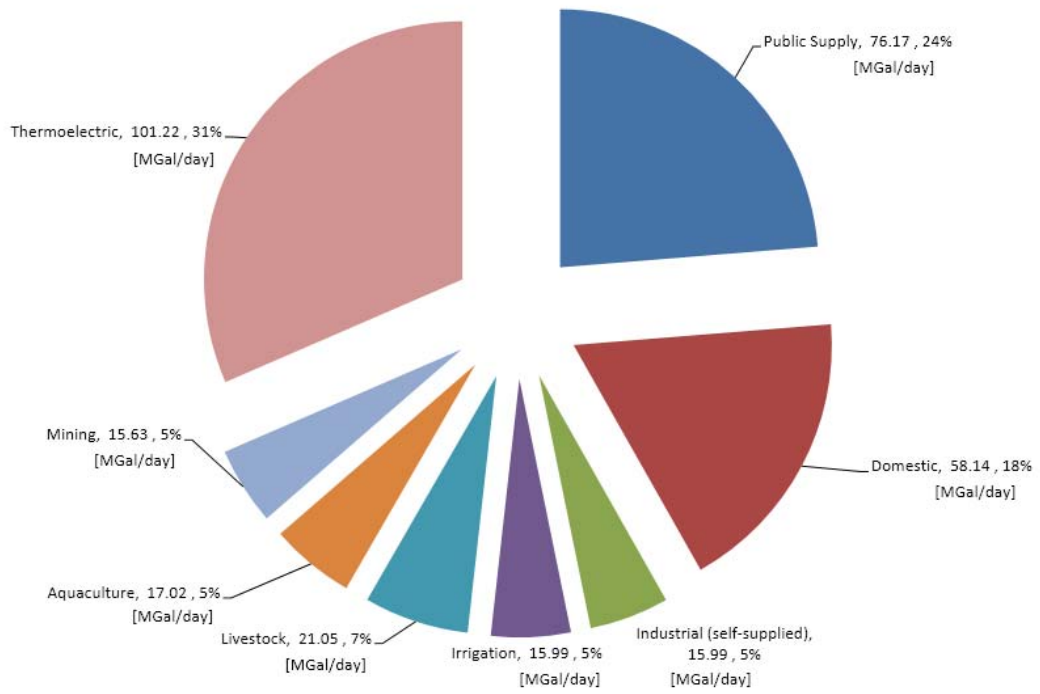
#### **HISTORIC VERSUS FUTURE STREAMFLOW DEPLETIONS**

Human interaction with river systems can alter stream flows through changes in timing of flows, introduction of new sources of water, and depletions through consumptive use. The upper basin headwater reservoirs, operated by the U.S. Army Corps of Engineers, can alter the timing of flows by storing snowmelt runoff and releasing storage during period of low flows to supplement navigation. Introduction of new sources of water to a river basin can occur when a community withdraws water from one river basin and returns it to a different basin. This may also include withdrawal from groundwater source with a return to surface water.

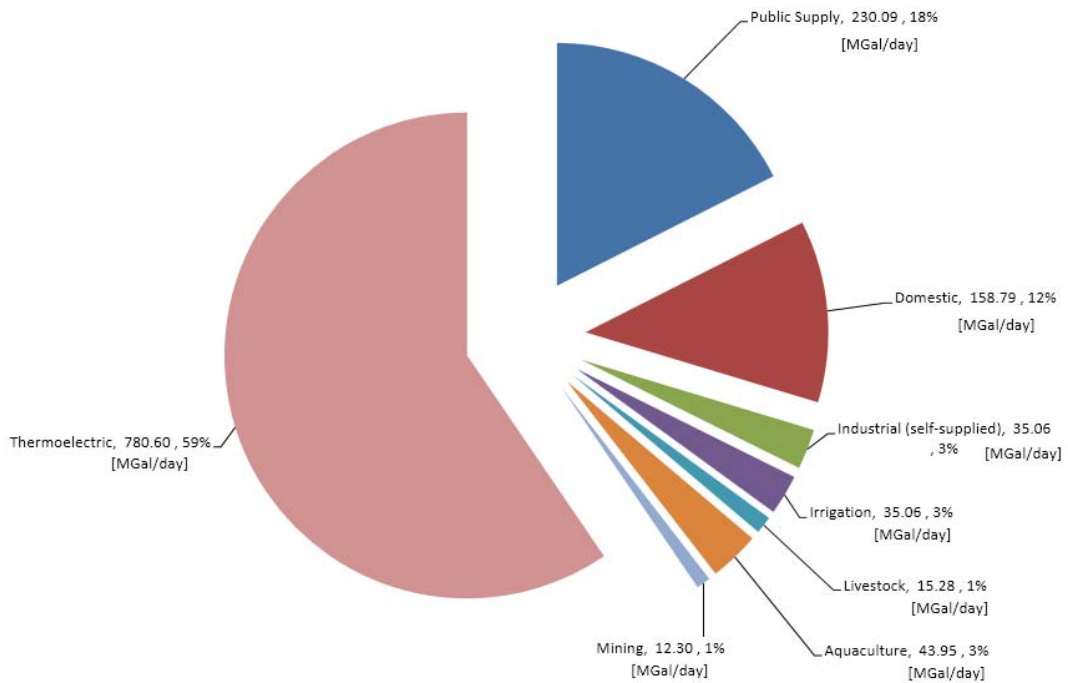
Consumptive uses are withdrawals of water from one source that is not returned to the same source. The U.S. Geological Survey compiles water use surveys every five years. The most recent survey, covering years 2000 to 2005, provides average withdrawals for various types of water use. These water uses are both consumptive and non-consumptive in nature. Chart A2-8 provides the compiled average annual water uses for the Minnesota River Basin above Fort Snelling State Park. The majority of the water uses are related to thermoelectric power production (e.g., cooling) and public or private water supply. Chart A2-9 provides the water uses in the Mississippi River basin above St. Paul, showing a larger role in power generation.

Consumptive uses can reduce river flows. Estimation of historic river flows incorporates the historic depletions. If the climatic conditions which produced the critical drought of record, the 1930s drought, were to reoccur the current or future depletions on the river could result in lower flows than historically observed. Chart A2-10 shows the population growth in the Minnesota and Mississippi river basins, with population increasing 120% from the 1930s to present day. The states within the basin provide population projections to year 2040, with overall estimates of an additional 17% increase in population from current conditions. Likewise, estimates of irrigated acreage in Minnesota early in the 20<sup>th</sup> century were a fairly small amount (Chart A2-11). Current census of irrigated acreage exceeds half a million of acres.

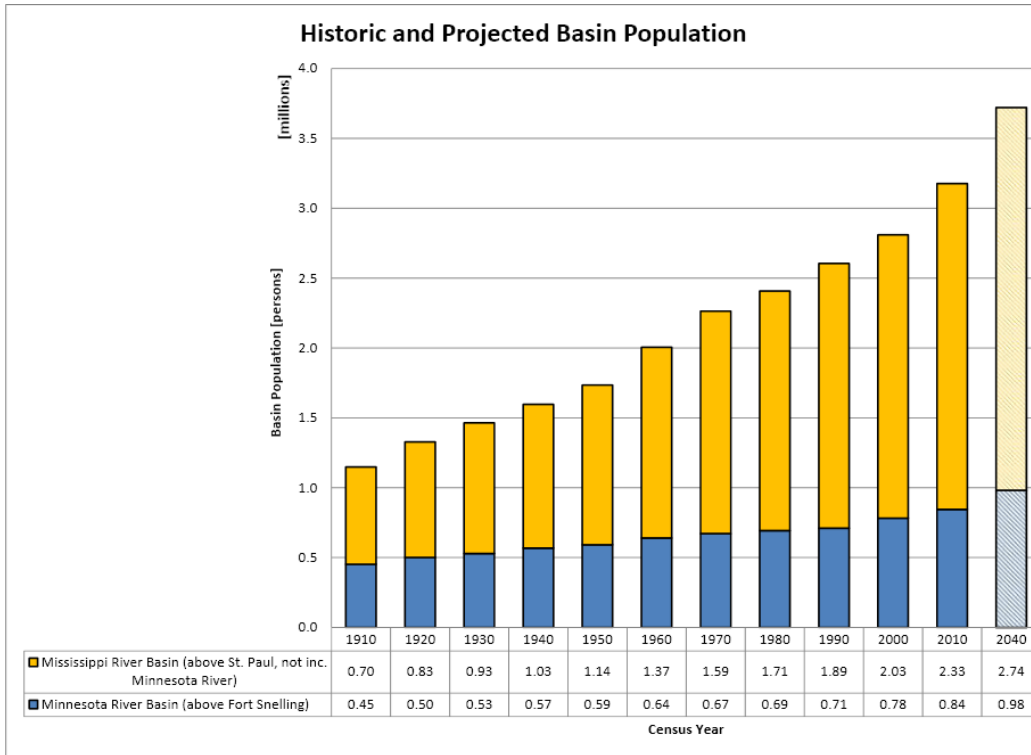
The process of accounting for historic, current, and future basin depletions and other river operations is called naturalized flow. Historic gage flow is adjusted for the historic depletions and other operations, resulting in estimates of river flow that might have occurred if human influence was removed. Demand scenarios are then developed that add current or future depletions along with river operations to the naturalized flow. This process provides a revised and more realistic estimate of water supply based on historic climate.



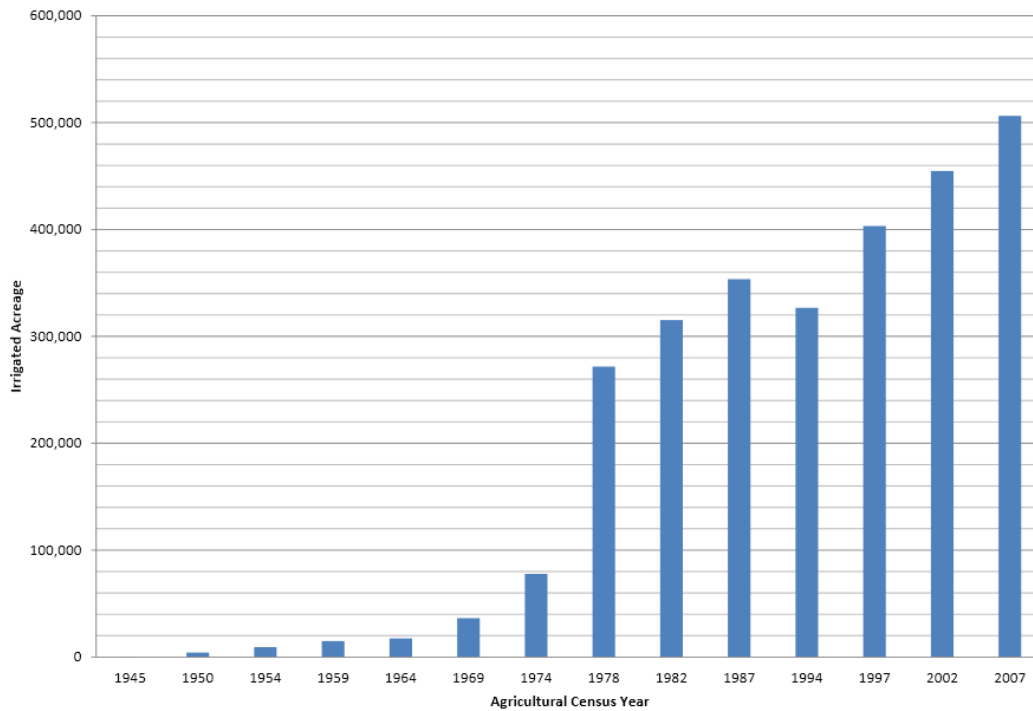
**Chart A2-8. Average Annual Water Use for Minnesota River Basin (2000 to 2005)**



**Chart A2-9. Average Annual Water Use for Mississippi River Basin (2000 to 2005)**



**Chart A2-10. Historic and Projected Basin Population**



**Chart A2-11. Number of Irrigated Acres, State of Minnesota**

### **DAILY FLOW AND DEMAND VARIATIONS**

The surface water supply analysis evaluated river flows, demands, and shortages on an average monthly basis. Principally, this approach allows for additional accuracy in reconstructing historic stream flows. Differences in travel time occurring between a source gage, with measured data, and a target gage, that is missing data, is largely negated when averaged over a month. Averaging also reduces effects that isolated thunderstorms or snowpack differences may have within a watershed. However, monthly averaging can obscure day-to-day fluctuations that have implications on surface water supply.

Chart A2-12 shows an example of the Mississippi River at St. Paul gage for calendar year 1988. The daily measured data is plotted along with the computed monthly averages. Daily variations create times during a month when flows can sometimes exceed and also be below the monthly average. The monthly average itself may hide times when excess flows are available but not necessarily able to be diverted due to short-term and rapid changes in the river flow. Similarly, times when the daily flow is below the monthly average may represent a shortage in supply.

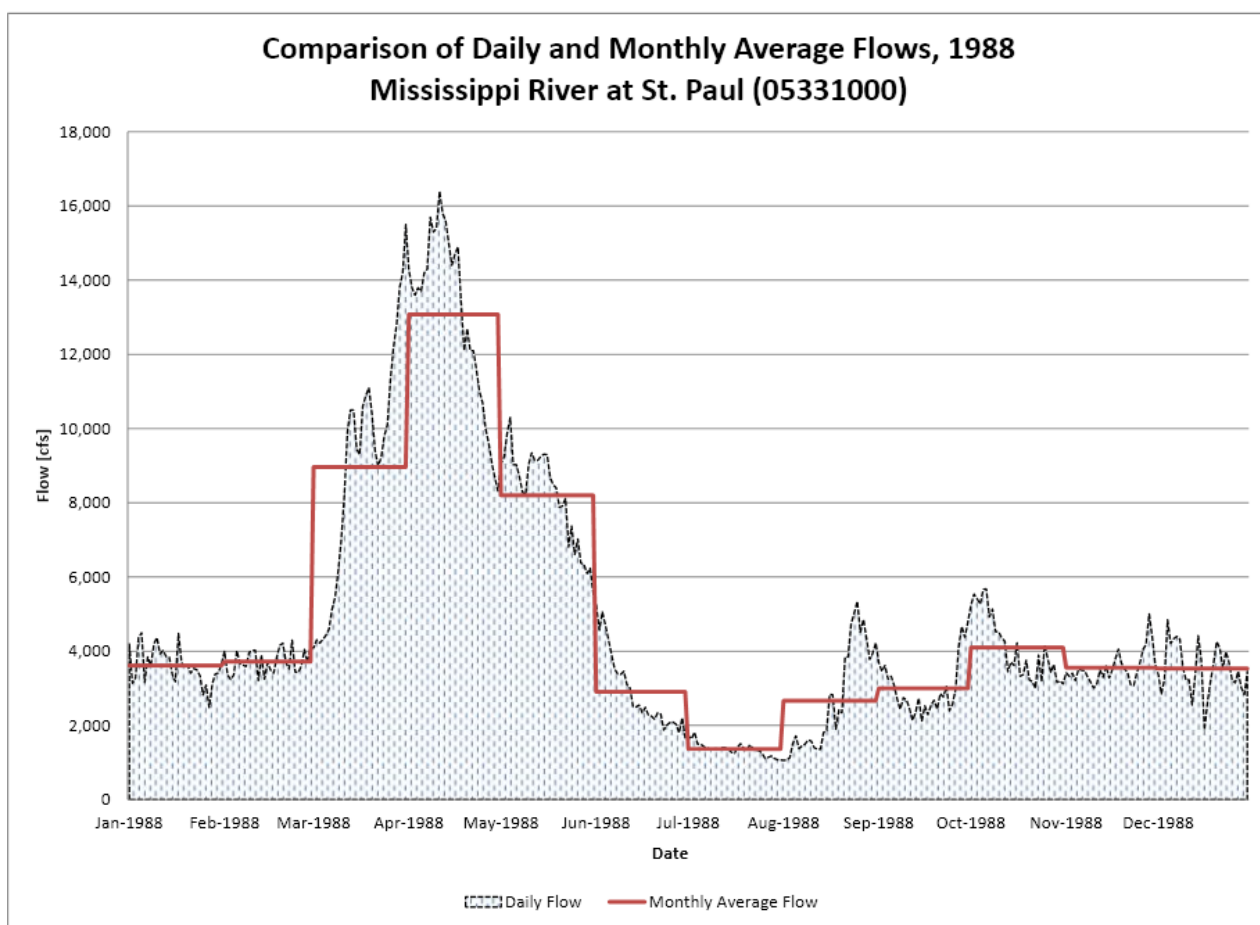
Daily variation in demands also factor into a shortage analysis. There are day-to-day variations in overall demand, seasonal trends, and peak day demands. These demand variations can also be thought of, to some extent, as inverse to the supply variations. As supply reduces from reduced precipitation and increased temperatures, demand tends to increase. A shortage analysis which compares daily variation in supply and demands could be approached with detailed basin water budgets and modeling. Another approach is applying the Maintenance of Variance Extension approach on daily data but also accounting for travel time between reference stream gages. The monthly average flows could also be disaggregated with daily flow patterns, or converted into a given probability of demand meeting supply.

### **OTHER CONSIDERATIONS**

Other considerations in evaluating available surface water supply relate to the physical and legal capability to divert flows and future availability of stream flow. One issue discussed is protected water uses and downstream needs. Even traditionally non-consumptive uses of water can impact river flows in such a way to generate undesirable impacts to other water users and potentially create a situation regulated by water law. During the 1987 to 1990 drought, for example, upstream run-of-river hydropower production on the Mississippi river created fluctuations in river flows from gate operations. A subsequent agreement amongst the mainstem Mississippi water users sought to better coordinate these operations during low flow events. There are also the physical aspects that control the extent that water can be diverted. A direct surface water diversion may require a given minimum flow in the river to create sufficient water surface elevations that promote flow to a water treatment plant. Water quality or sediment entrainment may become an issue during low flows as well. Diversions utilizing an infiltration gallery or collector wells may not be susceptible to these low flow issues but have restrictions based on geology and local soils.

Climate change or climate trends are a consideration in evaluation future variation in surface water supply. The traditional approach in surface water supply availability is evaluating historic climate variability against current or future demands.

Both historic climate indices and subsequent shortage analysis illustrates more frequent drought and potential shortages in the climate experienced in the early to mid-20<sup>th</sup> century as opposed to the last twenty or so years. The U.S. Army Corps of Engineers considered climate trends in a study of a proposed flood management diversion on the Red River for the Fargo-Moorhead metropolitan area (USACE, 2011). While it is possible that the generally wetter climate conditions may not continue in the future, an inter-agency working group developed flood frequency design flows emphasizing the recent climate as opposed to the earlier, dryer, timeframe. From a water supply perspective, climate change can include annual water supply availability and variability along with changes in seasonal river flows. Demands can also be impacted by climate change, for example higher temperatures driving higher demands.



**Chart A2-12. Example of Daily and Monthly River Flows**

**CONCLUSIONS**

This feasibility study used measured and estimated river flows at two potential and representative surface water supply locations, on the Minnesota River and Mississippi River. Past climatic variability was used to determine the potential for surface water supply. The availability of surface water supply did not take into consideration daily fluctuations in river flows and demands.

Nor did this study attempt to determine how past climate might translate into future river flows given population, agricultural, commercial, and industrial growth that has occurred in the past and projected to occur in the future.

Several historic droughts were evaluated. The drought extending from 1930 to 1940 was the most severe in terms of annual streamflow, resulting in 9% of average annual volume for the Minnesota River and 15% of average annual volume for the Mississippi River in the worst year of the drought. The 1987 to 1990 drought, while not the most severe in terms of annual streamflow, had characteristics which resulted in lower summer flows than typically found in other droughts. The worst year in this latter drought event appears to have similar potential impacts to public water supply as the 1930s drought.

Given the scope of this analysis, both the Minnesota River and Mississippi River locations appear to have physically adequate streamflow diversion potential to meet projected year 2040 area demands. However, the needs of competing and equal priority water uses along with minimum resource flows needed for water quality, navigation, and riparian habitat needs must also be considered. The 90th percentile river flow ( $Q_{90}$ ) is typically adopted by the Minnesota Department of Natural Resources as a minimum in-stream flow. Using a scenario which assumes no surface water diversions could occur if river flows drop below this threshold, an annual shortage of around 85% of demand could occur in the worst drought year using year 2040 study area demands. This is also not the most conservative conclusion on the possible extent of a single year shortage, as additional regional demands and water quality might increase the shortages.

The Minnesota River or Mississippi River downstream of the confluence of the Minnesota River appears to be a viable option for water supply diversion. Further refinement needs include examining water uses in the larger watershed as well as incorporating specifics on the location and nature of a potential water supply diversion. Critical drought years may pose challenges for a surface water supply. Establishing coordination with river stakeholders would be an advisable component in pursuing a surface water supply. Maintaining secondary supplies for daily fluctuations in flow and to meet certain demands during critical drought years is also important. The USACE headwaters reservoirs have been explored in the past as a possible source, although these reservoirs are not authorized for such supplemental supply and USACE has cautioned against incorporating these reservoirs into formal supply plans. More likely, conjunctive supplies using available well fields may serve as a supplemental source to a surface water supply during drought when streamflow is limited.

### **Appendix A3: Collector Well Evaluation**

An analysis of existing geology data was performed to assess the potential development of collector wells in the study area. Areas along the Minnesota River on the western side of the study area, and along the Mississippi River along the northern and eastern sides of the study area were included in the analysis. Areas shown to have 80 or more feet of unconsolidated material (primarily sand and gravel) with limited clay and silt thickness were considered for collector wells.

#### **MINNESOTA RIVER COLLECTOR WELLS**

Much of the study area adjacent to the Minnesota River is underlain by shallow bedrock or thick sequences of clayey till materials that are unsuitable for collector wells. A bedrock valley trends roughly east-west across Dakota and Hennepin counties and intersects the Minnesota River about one mile north of the Seneca Wastewater Treatment Plant in Eagan. The sediments in the bedrock valley were studied for the purpose of potentially siting collector wells in the area. A map showing the locations of borings completed by the Minnesota Department of Transportation (MnDOT) and others in the vicinity of the bedrock valley is included in Attachment A3-1. Copies of the MnDOT boring logs and one well log report from the County Well Index (CWI) that correspond with selected locations on the map are also included in Attachment A3-1. All of the selected borings are within 1.5 miles of the bedrock valley and none appear to be within the bedrock valley.

Comparing bedrock elevation contours by Mossler (2013) to an approximate land surface elevation of 700 feet AMSL indicates about 300 feet of sediment may overlie bedrock in the bedrock valley at the Minnesota River. The boring logs, none of which intersect the bedrock valley, indicate approximately 120 to 180 feet of unconsolidated sediments overlie Prairie du Chien dolomite. Unique No. 205592 is the nearest boring to the bedrock valley, and the unconsolidated materials are 180 feet thick at this location. The sediments are heterogeneous, with little in common between each boring log. Unique No. 205592 shows 45 feet of clay at the surface, with 135 feet of primarily sand and gravel below the clay. Unique No. 3877 shows 70 feet of silty clay underlain by 80 feet of sand. Unique No. 50199 shows 90 feet of primarily silty clay underlain by 40 feet of sand and gravel. These well locations are shown on the map in Attachment A3-1.

The available boring logs in the vicinity of the bedrock valley near the Minnesota River indicate 45-90 feet of silty clay underlain by 40-135 feet of sand and gravel. The sand and gravel represents a potential target formation for horizontal collector well screens. The fine-grained material above the sand and gravel could potentially limit the rate of vertical recharge to the collector well from the Minnesota River. This could result in an increased ratio of groundwater-to-surface water withdrawal if collector wells were developed at this location, and the well yields would not be as high as in a situation with a more direct connection to the river. While the material on the boring logs does not represent the ideal situation for collector well yield, some thickness of fine material is preferable for riverbank filtration, and significant amounts of water could still be withdrawn from a properly designed and constructed well. Viability of a collector well would need to be determined through site-specific test drilling and aquifer testing.



### **MISSISSIPPI RIVER COLLECTOR WELLS**

Similar to the Minnesota River, the study area adjacent to the Mississippi River is underlain by mostly shallow bedrock or thick sequences of clayey till. There is a bedrock valley that trends roughly north-south under the Mississippi River on the east side of South St. Paul in Dakota County. The analysis focused on characterizing the sediments in the bedrock valley for the purpose of potentially siting collector wells. Well logs available in the CWI were reviewed. One area of South St. Paul along the Mississippi River appears to have sufficiently thick sediments overlying bedrock, and this area was targeted for review. Well locations that have reasonably descriptive logs are shown on a map in Attachment A3-2. Copies of the corresponding well log reports from the CWI are included in Attachment A3-2.

Unique Nos. 200672 and 229119 have relatively thorough descriptions of the unconsolidated geology. Both logs indicate about 170-190 feet of unconsolidated material overlying Jordan sandstone. Sand is the dominant material, with some gravel. Two to three clay lenses ranging from 1 to 20 feet each in thickness are noted in each boring. Unique No. 200672 has notes of cobbles from 115-135 feet below ground surface. Glacial drift is noted in Unique No. 229119 from 103-186 feet below ground surface, with no detailed description, and could conceivably range from clay till to coarse-grained outwash. These well locations are shown on the map in Attachment A3-2.

The relatively thick sequence of sandy material may pinch out within a few hundreds of feet to the north and south of Unique Nos. 200672 and 229119. Unique No. 200668 indicates only 102 feet of unconsolidated material overlying Prairie du Chien dolomite. The log shows sand and clay from 7-82 feet below ground surface, and sand from 82-102 feet below ground surface. Unique No. 200670 indicates 137 feet of unconsolidated material overlying Prairie du Chien dolomite. Clays are more significant in this location, comprising about 78 feet of the unconsolidated formation with the remainder being sand and gravel.

The available boring logs in the vicinity of the bedrock valley near the Mississippi River in South St. Paul indicate a narrow zone (approximately 600 feet, measured north to south) where appreciable thickness of sand and gravel material exists. The sand and gravel represents a potential target formation for horizontal collector well screens. The clay lenses noted within the sand and gravel could potentially limit the rate of vertical recharge to the collector well from the Mississippi River. This might result in an increased ratio of groundwater-to-surface water withdrawal, and the well yield would not be as high as in a situation with a more direct connection to the river. While the material on the boring logs does not represent the ideal situation for collector well yield, some thickness of fine material is preferable for riverbank filtration, and significant amounts of water could still be withdrawn from a properly designed and constructed well. Viability of a collector well would need to be determined through site-specific test drilling and aquifer testing.

### **COLLECTOR WELL DESIGN**

Design methods for collector wells are similar to vertical wells. A site-specific hydrogeologic evaluation, including test drilling, surface geophysics, and aquifer pumping tests should be performed at each potential collector well site.

Preliminary estimates of well yield can be calculated from field estimates of aquifer hydraulic conductivity and transmissivity, and well screen dimensions and materials can also be selected. During installation of the collector well there is opportunity for making changes to the well screen design when using the projection-pipe method (Sterrett, 2007). This method allows for collection of soil samples during drilling which can be used to modify the well design while the hole is held open by the projection pipe. Filter pack material can also be installed around the well screen if necessary to maximize well yield and prevent sand pumping.

**ATTACHMENT A3-1: MINNESOTA RIVER COLLECTOR WELL EVALUATION – WELL LOGS**

Save Map As:  
Right-click and select "Save Picture As..."



Unique Well No.  
205592

Approximate limits  
of bedrock valley

MINNESOTA HIGHWAY DEPARTMENT  
MATERIALS AND RESEARCH SECTION  
LOG OF TEST BORING

UNIQUE NUMBER **3877**  
**3878**

Project: SP 2785-01 TH 494

Machine : Highmark (0-80) (80-160.5) Core Drill # 1  
Supervisor: D. Nyquist K. Washie  
Operator : A. Cruse K. Hendrickson

Laboratory No.: (0-80) FS 61338-66  
(80-160.5) FS 62448-56

Resistance Hammer 140 lbs.  
Sounding Drop 30 in.  
Blows per Foot Sampler 2 in O.D.

Vertical Scale: 1 inch = 5 feet

Boring No.: T-3 # 3A Date: (0-80) 5-1-61  
Location: Sta 32+45, & EBB (80-160.5) 2-7-62  
Surface Elev.: 701.0

Boring No.: [ ] Date: [ ]  
Location: [ ]  
Surface Elev.: [ ]

Depth	Description	BPF
0	sl. pl. SANDY LOAM, dk. brown	
2	Water table at surface	
	FINE SAND and LOAMY SAND brown	2
7		5
		* W.H.
	SILTY CLAY LOAM organic, dark grey o.c. = 3.5%	W.H.
		W.H.
28		3
	SILTY CLAY organic, dark grey	4
35	o.c. = 3.1% continued next column * weight of hammer	

Depth	Description	BPF
35		
		4
		3
	SILTY CLAY LOAM organic, dark grey	3
	o.c. = 4.6%	W.H.
		2
		4
65		
	SILTY CLAY, dark grey sl. organic, FS, some	
68		29
	SILT LOAM, L. SAND and SAND grey, with rocks	
70	continued next page	

MINNESOTA HIGHWAY DEPARTMENT  
MATERIALS AND RESEARCH SECTION  
LOG OF TEST BORINGS

3877

Project: SP 2785-01 TH 494

Machine :

Supervisor:

Operator :

Laboratory No.:

Resistance  
Sounding

Hammer  
Drop  
Sampler

lbs  
in.  
in C.D.

Vertical Scale: 1 inch = 5 feet

Blows per Foot

Boring No.: T-3 cont Date:  
Location: Sta 32+45 & L<sup>E</sup> EBR  
Surface Elev.: 701.0

Boring No.: T-3 cont Date:  
Location:  
Surface Elev.:

Depth	Description	BPF
70		
	SAND, dark brown	30
		22
78		25
80	Boring extended by CD#1, 2-7-62	50
		34
	FINE-MEDIUM SAND brown	53
		47

Depth	Description	BPF
105		
	same as above, FINE-MEDIUM SAND	83
115		24
	MEDIUM SAND brown	38
		45

105 continued next column

115 continued next page

MINNESOTA HIGHWAY DEPARTMENT  
MATERIALS AND RESEARCH SECTION  
LOG OF TEST BORINGS

Project: SP 2785-01 TH 494

Machine :  
Supervisor:  
Operator :

Laboratory No.:

Resistance Sounding } lbs.  
Blows per Foot } in.  
Hammer } in C.D.  
Drop  
Sampler

Vertical Scale: 1 inch = 5 feet

Boring No.: T-3 Cont Date:  
Location: Sta 32+45, 6 LE BR  
Surface Elev.: 701.0

Boring No.: Date:  
Location:  
Surface Elev.:

Depth	Description	BPF
140	Same as above, MEDIUM SAND brown	
142.8	SILT LOAM, grey, stiff	
145.8	MEDIUM SAND, grey	35
150.5	Top of Bedrock elev. 550.5  Onota DOLOMITE cored 9.7' 98% Recovery	
160.5	Bottomed at elev. 540.5 in Dolomite	

Depth	Description	BPF

**UNIQUE NUMBER** 50199  
**MINNESOTA HIGHWAY DEPARTMENT - OFFICE OF MATERIALS**  
**LABORATORY LOG & TEST RESULTS - SUBSURFACE EXPLORATION**

S.P.:	1925-	Bridge No. or Job Desc.:	9600	T.H.:	36	Boring No.:	780	Gnd. Elev.:	700.9
Location:								Lab. No.:	
Sta. <u>N.B. STA. 1140+00, F</u>								FS. <u>75-0697</u> thru <u>75-0731</u>	
Supervisor:			Operator:			Machine:			
R. Nelson			R. Lueck			C.M.E. NO. 63732			
Drilling Started:		Drilling Completed:		Hammer:		Drop:		O.D.:	
2-18-75		2-25-75		140 #		30"		2"	

**Notes to Users of Laboratory Logs:**

This boring was made by ordinary and conventional methods and with care deemed adequate for the State's design purposes. However, since this boring was not taken to gather information relating to the construction of the project, the data noted in the field and recorded may not necessarily be the same as that which a contractor would desire. Therefore, while the State believes that the information as to the conditions and material reported is accurate, it does not warrant that the information is necessarily complete. This log has been edited or abridged and may not reveal all information which might be useful or of interest to the contractor. (Field notes are available on request.) Since subsurface conditions outside of each individual test hole are unknown to the State and soil, rock and water conditions cannot be relied upon to be consistent or uniform, no warrant is made that conditions adjacent to this boring will necessarily be the same as shown on this log. Furthermore, the contractor shall accept complete responsibility for any interpretations, assumptions, projections or interpolations made by his organization, in using this boring log.

A notation regarding water has been made on this log. Individual water levels and levels of great divergence between logs should be used with discretion as the use of drilling fluids and drilling muds may seriously distort the true conditions. Also, it can be expected that water levels will vary from season to season and year to year.

Cohesion values followed by an asterisk were obtained from samples recovered with a thin-wall type sampler. All others are split-tube samples. Before these cohesion values are averaged or used in any computations, the original laboratory data sheets should be checked for any unusual factors which might have a bearing on the cohesion values; such as, high moisture content, high densities, cracks or stones in the original sample, etc. Data sheets are available in the Foundations Laboratory, Office of Materials. "Cohesions" are assumed to be 1/2 of the unconfined compressive strength.

**EXPLANATION OF ABBREVIATIONS**

<p style="text-align: center;"><u>WATER MEASUREMENT</u></p> <p>AB - After Bailing  AC - After Completion  AF - After Flushing  w/C - With Casing  w/M - With Mud  WSD - While Sampling or Drilling</p> <p>or combination of the above such as  WSD-w/C</p> <p style="text-align: center;"><u>SOIL TYPE</u></p> <p>C - Clay  L - Loam  Org - Organic  S - Sand  Sl - Silt  T - Till  G - Gravel (No. 10 sieve to 3")  Blkr - Boulder (over 3")</p> <p>or combination of the above such as  SL</p> <p style="text-align: center;"><u>TESTS</u></p> <p>BPF - Blows Per Foot  Hydro - Hydrometer Analysis  LL - Liquid Limit  MC - Moisture Content  PL - Plastic Limit  PI - Plasticity Index  Org Con - Organic Content  <sup>2</sup>d - Dry Density  <sup>3</sup>d - Wet Density</p>	<p style="text-align: center;"><u>MISCELLANEOUS</u></p> <p>DM - Drilling Mud  Gnd - Ground  N/A - Not Applicable  NSR - No Sample Retrieved  w/ - With  w/o - Without  WH - Weight of Hammer  WR - Weight of Rod  wx - Weathered</p> <p style="text-align: center;"><u>MOISTURE CONDITION</u></p> <p>Sat - Saturated</p> <p style="text-align: center;"><u>COLOR</u></p> <p>blk - Black  bwn - Brown  dk - Dark  gr - Gray  grn - Green  lt - Light  wht - White  yel - Yellow</p> <p style="text-align: center;"><u>OPERATION</u></p> <p>AUG - Augered  CD - Core Drill  DBD - Disturbed by Drilling  DBJ - Disturbed by Jetting  PD - Plug Drill  ST - Split-Tube  TW - Thin-Wall  WS - Wash Sample</p>	<p style="text-align: center;"><u>PLASTICITY</u></p> <p>pl - Plastic  sl pl - Slightly Plastic  non pl - Nonplastic</p> <p style="text-align: center;"><u>GRAIN SIZE</u></p> <p>VF - Very Fine  F - Fine  M - Medium  Cr - Coarse</p> <p style="text-align: center;"><u>OTHER (Explain)</u></p>
---	---	---



NOTE: This log is not complete if heading sheet is not attached.

Gnd. Elev. 700.9

DEPTH (1" = 3')	GRAPHIC LOG		BPF	"COHESION" (lbs./ft. <sup>2</sup> )	MOISTURE CONTENT (%)	OTHER LAB TESTS
	By: <u>N.M.</u> Lab Desc.	<u>F.B.</u> Graphic Log Rock Desc.				
0.0		LS & G (Loam Sand & Gravel) bwn. & wet	20		19	
2.5		SiCL sl. org. (Silty Clay) bwn. & v-moist Stiff to firm	11	1470	33	
6.5		SiCL (Silty Clay) bwn. v-moist to wet soft	7		32	
			2	750*	31	
					37	
			2	290*	34	
			2	280	32	
17.5		SiCL, SiC, & FSL ph Layered gr, wet, & soft (Silty Clay)		410*	30	LL = 38 PI = 17
20.0		SiCL w/ FS seams gr, wet, & soft (Silty Clay)	3	250	33	
				420*	33	
25.0		SiC sl. org. (Silty Clay) gr, wet, & soft	3		38	
27.5		FS w/sic seams (Fine Sand) gr. & wet			11	
30.0		Continued on next sheet				

Form 243A (2-70)

S.P. 1925-  
 Bridge No. 2600 T.H. E 36  
 or Job Desc. N.B. STA. 1140+00  
 Boring No. T80  
 Sheet 2 of 6  
 cont'd.

MINNESOTA HIGHWAY DEPARTMENT - OFFICE OF MATERIALS  
 LABORATORY LOG & TEST RESULTS - SUBSURFACE EXPLORATION

NOTE: This log is not complete if heading sheet is not attached.

Gnd. Elev. 100.7

DEPTH (1" = 3')	By: <u>N.M.</u> Lab Desc.	GRAPHIC LOG <u>EE</u> Graphic Log	Rock Desc.	BPF	*COHESION* (lbs/ft <sup>2</sup> )	MOISTURE CONTENT (%)	OTHER LAB TESTS
30.0		Same as Above (Fine Sand)		WH		32	
				11		23	
35.0		Sic (Silty Clay) w/FS seams & FSL pl. Layer gr, wet, & firm		6	690	35	
				4	480	38	
				8	480	35	
					540*	37	
				6		37	
					340*	35	
				6			
				6		33	
					220*	31	
60.0		Continued on next sheet					

DEPTH (1" = 3')

Form 2443A (2-70)

SP. 1925-

Bridge No. 9600 T.H. 36 Sheet 5 of 6

or Job Desc. M.B. STA. 1140 + 0.6 E Boring No. T80 cont'd.

MINNESOTA HIGHWAY DEPARTMENT - OFFICE OF MATERIALS  
LABORATORY LOG & TEST RESULTS - SUBSURFACE EXPLORATION

NOTE: This log is not complete, if heading sheet is not attached.

Gnd. Elev. 700.9

DEPTH (1" = 3')	GRAPHIC LOG		BPF	*COHESION* (lbs/ft <sup>2</sup> )	MOISTURE CONTENT (%)	OTHER LAB TESTS
	By: <u>N.M.</u> Lab. Desc.	<u>E.B.</u> Graphic Log Rock Desc.				
60.0	same as above (Silty Clay)		5		33	
				840*	43	
			4		33	
				570*	33	
70.0	SiCL w/LS seams (Silty Clay) gr, wet, & soft		WH		31	
					29	
75.0	LS TO FSL S.I.P.I. (Loam Sand) gr. & wet		7	470	27	
			WR			
83.0	SLT (Sand Loam Till) bwnl, wet, & stiff					
			12		10	
90.0	Continued on next sheet					

Form 2443A (2-70)

S.P. 1925  
 Bridge No. 9600  
 or Job Desc. N.B. 574 // 40+00  
 J.H. 36  
 Boring No. 780  
 cont'd.

MINNESOTA HIGHWAY DEPARTMENT - OFFICE OF MATERIALS  
 LABORATORY LOG & TEST RESULTS - SUBSURFACE EXPLORATION

Sheet 4 of 6

NOTE: This log is not complete if heading sheet is not attached.

Gnd. Elev. 700.9

DEPTH (1" = 3')	GRAPHIC LOG		Rock Desc.	BPF	"COHESION" (lbs/ft <sup>2</sup> )	MOISTURE CONTENT (%)	OTHER LAB TESTS
	By: <i>N.M.</i> Lab Desc.	<i>ER</i> Graphic Log					
90.0	<i>Same as above</i> <i>(Sand Loam Till)</i>			12		12	
93.0	<i>S</i> <i>(Sand)</i> <i>bwn &amp; wet</i>			13		15	
100.0	<i>SLT S.L.P.I.</i> <i>(Sand Loam Till)</i> <i>bwn; wet, &amp; stiff</i>			12		12	
101.5	<i>S</i> w/ some <i>SLT</i> <i>(Sand)</i> <i>bwn &amp; gr.</i>			6			
				20			
				29			
120.0	<i>Continued on next sheet</i>						

Form 2443A (2-70)

S.P. *1925-* Bridge No. *9600* of Job Desc. *M.B. 57th 1/40+00* I.H. *36* Boring No. *780* Sheet *5* of *6* cont'd.

MINNESOTA HIGHWAY DEPARTMENT - OFFICE OF MATERIALS  
LABORATORY LOG & TEST RESULTS - SUBSURFACE EXPLORATION

NOTE: This log is not complete if heading sheet is not attached.

Gnd. Elev. 100.2

DEPTH (1" = 3')	By: N.M. Lab Desc.	GRAPHIC LOG E.B. Graphic Log	Rock Desc.	BPF	"COHESION" (lbs/ft <sup>2</sup> )	MOISTURE CONTENT (%)	OTHER LAB TESTS
120.0		S & G w/ some FS (Sand and Gravel) bwn, moist & dense		46			
				67		9	
131.1		End of boring at elev. 569.8		75/0.6		16	
		FLOWING ARTESIAN AT 105' (2' Head) 7' Head at 121.5'					

Form 2443A (2-70)

SP. 1925-

MINNESOTA HIGHWAY DEPARTMENT - OFFICE OF MATERIALS  
LABORATORY LOG & TEST RESULTS - SUBSURFACE EXPLORATION

Bridge No. 9600 T.H. 36  
or Job Desc. W.B. 574, 1140 + 00 E

Boring No. T 80

Sheet 6 of 6

cont'd.

MINNESOTA DEPARTMENT OF TRANSPORTATION - GEOTECHNICAL SECTION  
 LABORATORY LOG & TEST RESULTS - SUBSURFACE EXPLORATION



**UNIQUE NUMBER 52335**

U.S. Customary Units

State Project		Bridge No. or Job Desc.		Trunk Highway/Location		Boring No.		Ground Elevation			
2782-220		5983		Interstate Highway 35W		T-35		730.0 ( )			
Location Hennepin Co. Coordinate: X=524393 Y=104499 (ft.)						Drill Machine Failing 72346		SHEET 1 of 2			
Latitude (North)=44°48'12.28" Longitude (West)=93°17'21.7"						Hammer 140#/30" Drop		Drilling Completed 2/11/83			
TH 35, 102+17, 120' RT								Other Tests Or Remarks			
DEPTH	Depth	Lithology	Classification	Drilling Operation	SPT	MC	COH	γ	Rock	Soil	Formation or Member
	Elev.				N <sub>60</sub>	(%)	(psf)	(pcf)			
	3.0		Slightly Organic, slightly plastic Fine Sandy Loam; Dark brown; Damp			11					
	727.0		Slightly Organic, plastic Fine Sandy Loam; Black; Moist		24	14					
5	3.7		Loamy Fine Sand with Fine Sand seam; Light brown with brown; Moist	PD	37	19					
	726.3		Loamy Sand and Gravel; Brown; Moist	PD	42	12					
	5.0		Plastic Fine Sandy Loam; Dark brown; Moist	PD	72	18					
10	725.0		Organic Slightly Plastic Fine Sandy Loam; Black; Moist	PD	75	9					
	6.7		Fine Sand; Light brown; Moist	PD	56	15					
	723.3		Clay Loam with organic plastic Fine Sandy Loam seam; Gray-brown with dark brown; Moist	PD	61	15					
15	722.5		Loamy Sand; Brown; Moist	PD	50	15					
	7.5		Sand; Brown, gray-brown; Moist, wet	PD	70	NSR					
	720.8		Mixed Clay Loam with slight organic Fine Sandy Loam; Brown, black; Moist	PD	50	11					
20	10.5		Sand; Brown, gray-brown; Saturated	PD	54	13					
	719.5		Slightly Organic Clay; Dark brown; Wet	PD	23	28					
	11.2			PD	14	35					
25	718.8			PD	28	560	114				
	13.6			PD	8	29					
	716.4			PD	28	660	114				
	23.8			PD	6	28					
30	706.2			PD	16	34	920				
	26.0			PD	37	720	109				
	704.0			PD	10	29					
35	30.0			PD	12	25					
	700.0			PD	26	730	115				
	35.3			PD	4	29					
40	694.7			PD	39	1860	107				
	63.0			PD	29	22					
65	667.0			PD	29	29					
	67.6			PD	29	22					
70	662.4			PD	29	29					
	73.6			PD	30	25					
75	656.4			PD							

Index Sheet Code

(Continued Next Page)

Soil Class: Rock Class: Edit: Date: 2/14/11  
 G:\GINT\PROJECTS\ARCHIVE\UID27\HENNEPIN\2782-220\ADB1.GPJ

MINNESOTA DEPARTMENT OF TRANSPORTATION - GEOTECHNICAL SECTION  
 LABORATORY LOG & TEST RESULTS - SUBSURFACE EXPLORATION



**UNIQUE NUMBER 52335**

U.S. Customary Units

Mn/DOT GEOTECHNICAL SECTION - LOG & TEST RESULTS										SHEET 2 of 2	
State Project		Bridge No. or Job Desc.		Trunk Highway/Location			Boring No.		Ground Elevation		
2782-220		5983		Interstate Highway 35W			T-35		730.0 ()		
DEPTH	Depth	Lithology	Classification	Drilling Operation	SPT	MC	COH	$\gamma$	Rock	Other Tests	
	Elev.				N <sub>60</sub>	(%)	(psf)	(pcf)		Soil	Or Remarks
								Formation or Member			
80			Silty Clay; Dark gray-brown; Moist (continued)	PD	20	30	2770	112			
				PD		28					
				PD	20	32	2140	111			
				PD		30					
	88.0			PD	20	31	2210				
	642.0			PD	19	29					
				PD		35	2650				
			Silty Clay Loam with plastic Silty Loam layer at 99'; Gray-brown; Moist	PD		32					
				PD	15						
	104.0			PD			NSR				
	626.0			PD							
			Silty Clay; Gray-brown; Moist	PD	10	32					
				PD							
	114.0			PD		36	900	105			
	616.0			PD							
			Clay; Dark gray-brown; Moist	PD	14	46					
				PD							
	124.5			PD		43					
	605.5		Coarse Sand and Gravel; Gray; Saturated	PD							
	127.0			PD							
	603.0		Weathered Limestone with Clay and wood chips; Yellow	PD							
	128.0		Top of Bedrock at 128'	WS						Top of Bedrock, 128'	
	602.0			WS						Prairie Du Chien Group	
			Prairie Du Chien Group Limestone, Limestone chips mixed with small amounts of clay and wood; Yellow	WS							
				WS							
135	135.5		End of Boring at 135.5'								
	594.5										

Soil Class: Rock Class: Edit: Date: 2/14/11  
 G:\GINT\PROJECTS\ARCHIVE\UID27\HENNEPIN\2782-220\ADB1.GPJ

MINNESOTA HIGHWAY DEPARTMENT  
MATERIALS AND RESEARCH SECTION  
LOG OF TEST BORINGS

UNIQUE NUMBER 3996

Project: S. P. 1982-02; Br. # 19864

Machine: Falling 595B1

Supervisor: C. Thomsen

Operator: E. P. Jarvis

Laboratory No.: F568883 - 896

Resistance Sounding  
Blows per Foot  
Hammer 140 lbs.  
Drop 30 in.  
Sampler 2.0 in O.D.

Vertical Scale: 1 inch = 5 feet.

Boring No.: T1 Date: 2-19-68  
Location: Sta. 19+20; 20' Pt. Q Yankee  
Surface Elev.: 896.0± Doodle Rd. =

Boring No.: T1, Cont'd [ ]  
Location: MED C.R. 28  
Surface Elev.: 581+10 20' Rt. 3-6-81 JLD

Depth	Description	BPF
0.0	Org. L; (Organic Loam) Moist, bik.	
4.0	Org. Silty L, Moist, (Organic Silt Loam) bwh.	17
5.5	SLT; sil. pl. to pl. (Sand Loam Till) Moist,	35
9.5	bwh.	19
9.5	LFSE & G (Loam Fine Sand and Gravel) Moist,	45
13.0	bwh.	
13.0	LS & G; (Loam Sand and Gravel) Wet,	48
		75/0.8
	gy. bwh.	
23.0	LS; (Loam Sand) Moist,	70
		70

Depth	Description	BPF
33.0	LS; (Loam Sand) Wet,	75/0.9
		75/0.6
	bwh.	
48.0	LS & G; (Loam Sand and Gravel) Wet,	75/0.9
		75
	bwh.	
58.0	SLT; (Sand Loam Till) Moist, bwh. med. firm, dense	30
		43
63.0	Bottom at elev. 833.0± in SLT. *Water measured at elev. 873 on 2-21-68	

35.0 Continued next column.





**ATTACHMENT A3-2: MISSISSIPPI RIVER COLLECTOR WELL EVALUATION – WELL LOGS**



### The Minnesota County Well Index



Minnesota Unique Well No.		County		Dakota	MINNESOTA DEPARTMENT OF HEALTH		Entry Date	06/08/1990			
<b>229119</b>		Quad	St Paul East		<b>WELL AND BORING RECORD</b>		Update Date	02/14/2014			
		Quad ID	103A		Minnesota Statutes Chapter 1031		Received Date				
<b>Well Name</b>		<b>Township</b>	<b>Range</b>	<b>Dir</b>	<b>Section</b>	<b>Subsections</b>	<b>Use</b>	<b>Depth Drilled</b>	<b>Depth Completed</b>	<b>Date Completed</b>	<b>Lic/Reg. No.</b>
ARMOUR WELL NO 5		28	22	W	23	CCCCCB	Industrial	447 ft.	447 ft.	00/00/1948	MGS
<b>Elevation</b> 695 ft. (Method 7.5 minute topographic map +/- 5 feet)		<b>Aquifer</b>		<b>Multiple</b>		<b>Depth to Bedrock</b> 186 ft.		<b>Open Hole</b> 255 - 447 ft.		<b>Static Water Level</b> 14 ft.	
<b>Field Located</b> Minnesota Geological Survey		<b>Location Method</b> Digitized - scale 1:24,000 or larger (Digitizing Table)		<b>Universal Transverse Mercator (UTM) - NAD83 - Zone 15 - Meters</b>		<b>Input Source</b> Minnesota Geological Survey		<b>UTM Easting (X)</b> 498089		<b>UTM Northing (Y)</b> 4970858	
<b>Unique No. Verified</b> Information from owner		<b>Input Date</b> 01/01/1990		<b>Interpretation Method</b> Geologic		<b>Agency (interpretation)</b> Minnesota Geological Survey		<b>Interpretation Method</b> Geologic		<b>Borehole Geophysics</b> Yes	
<b>Geologic Interpretation</b> Bruce Bloomgren		<b>Agency (interpretation)</b> Minnesota Geological Survey		<b>Interpretation Method</b> Geologic		<b>Interpretation Method</b> Geologic		<b>Interpretation Method</b> Geologic		<b>Borehole Geophysics</b> Yes	
		<b>DEPTH (ft.)</b>		<b>ELEVATION</b>							
<b>Geological Material</b>	<b>Color</b>	<b>Hardness</b>	<b>From</b>	<b>To</b>	<b>Thickness</b>	<b>From</b>	<b>To</b>	<b>Stratigraphy</b>	<b>Primary Lithology</b>	<b>Secondary Lithology</b>	<b>Minor Lithology</b>
CINDERS			0	3	3	695	692	man-made fill	Fill		
CLAY			3	16	13	692	679	clay	Clay		
FINE & COARSE-SAND & GRAVEL			16	20	4	679	675	sand +larger	Sand	Gravel	
COARSE SAND & GRAVEL			20	32	12	675	663	sand +larger	Sand	Gravel	
FINE & COARSE SAND & GRAVEL			32	42	10	663	653	sand +larger	Sand	Gravel	
COARSE SAND & GRAVEL			42	57	15	653	638	sand +larger	Sand	Gravel	
CLAY			57	62	5	638	633	clay	Clay		
FINE & COARSE-SAND & GRAVEL			62	72	10	633	623	sand +larger	Sand	Gravel	
FINE & COARSE SAND			72	94	22	623	601	sand +larger	Sand		
CLAY			94	95	1	601	600	clay	Clay		
COARSE SAND			95	103	8	600	592	sand	Sand		
GLACIAL DRIFT			103	186	83	592	509	Quaternary deposit	Drift		
JORDAN SANDSTONE			186	251	65	509	444	Jordan Sandstone	Sandstone		
ST. LAWRENCE FORMATION			251	295	44	444	400	St. Lawrence Formation	Dolomite	Sandstone	Shale
FRANCONIA FORMATION			295	424	129	400	271	Franconia	Sandstone	Shale	Dolomite
IRONTON-GALESVILLE FORMATIONS			424	447	23	271	248	Ironton-Galesville	Sandstone		
<b>County Well Index Online Well Stratigraphy Report</b>						<b>229119</b>		Printed 4/24/2014			

Minnesota Unique Well No.		County		Dakota		MINNESOTA DEPARTMENT OF HEALTH		Entry Date		12/01/1990		
<b>200672</b>		Quad		St Paul East		<b>WELL AND BORING RECORD</b>		Update Date		03/06/2014		
		Quad ID		103A		Minnesota Statutes Chapter 1031		Received Date				
Well Name	Township	Range	Dir	Section	Subsections	Use	Depth Drilled	Depth Completed	Date Completed	Lic/Reg. No.		
ARMOUR NO.3	28	22	W	26	BBBAC	Industrial	910 ft.	910 ft.	00/00/1920	27022		
Elevation	695 ft. (Method 7.5 minute topographic map +/- 5 feet)		Aquifer		Multiple	Depth to Bedrock	195 ft.	Open Hole	449 - 910 ft.		Static Water Level	48 ft.
Field Located	Minnesota		Location Method		Digitized - scale 1:24,000 or larger (Digitizing Table)		Universal Transverse Mercator (UTM) - NAD83 - Zone 15 - Meters					
Geological Survey	Unique No. Verified information from owner		Input Source		Minnesota Geological Survey		UTM Easting (X) 498147					
			Input Date		01/01/1990		UTM Northing (Y) 4970784					
Geologic Interpretation	Bruce Bloomingren		Agency (Interpretation)		Minnesota Geological Survey		Interpretation Method		Geologic study 1:24k to 1:100k		Borehole Geophysics Yes	
<b>DEPTH (ft.)</b>												
<b>ELEVATION</b>												
Geological Material	Color	Hardness	From	To	Thickness	From	To	Stratigraphy	Primary Lithology	Secondary Lithology	Minor Lithology	
SAND			0	4	4	695	691	sand	Sand			
CLAY			4	24	20	691	671	clay	Clay			
SAND			24	95	71	671	600	sand	Sand			
SAND & CLAY			95	115	20	600	580	clay+sand	Sand	Clay		
SAND & ROCKS			115	135	20	580	560	sand +larger	Sand	Cobble		
SAND			135	168	33	560	527	sand	Sand			
SANDSTONE		SOFT	168	188	20	527	507	sand	Sand			
SANDSTONE & SHALE			188	195	7	507	500	clay+sand	Sand	Clay		
SHALE			195	203	8	500	492	Jordan Sandstone	Sandstone			
SANDSTONE			203	204	1	492	491	Jordan Sandstone	Sandstone			
COARSE SANDSTONE			204	245	41	491	450	Jordan Sandstone	Sandstone			
SANDSTONE			245	265	20	450	430	St.Lawrence Formation	Dolomite	Shale	Sandstone	
SHALE			265	295	30	430	400	St.Lawrence Formation	Dolomite	Shale	Sandstone	
SHALE			295	305	10	400	390	Franconia	Sandstone	Shale	Dolomite	
SHALE, SANDY			305	330	25	390	365	Franconia	Sandstone	Shale	Dolomite	
SHALE			330	425	95	365	270	Franconia	Sandstone	Shale	Dolomite	
SHALE			425	452	27	270	243	Ironton-Galesville	Sandstone			
SANDSTONE			452	486	34	243	209	Ironton-Galesville	Sandstone			
SANDSTONE			486	492	6	209	203	Eau Claire Formation	Shale	Sandstone		
SHALE, SANDY			492	507	15	203	188	Eau Claire Formation	Shale	Sandstone		
SHALE			507	610	103	188	85	Eau Claire Formation	Shale	Sandstone		
SHALE, SANDY			610	695	85	85	0	Mt.Simon Sandstone	Sandstone	Shale		
SANDSTONE			695	885	190	0	-190	Mt.Simon Sandstone	Sandstone			
SHALE SANDY			885	895	10	-190	-200	Mid.Prot. sedimentary und.	Shale	Sandstone		
GRANITE			895	910	15	-200	-215	Keweenawan volcanics und.	Basalt			
County Well Index Online Well Stratigraphy Report						<b>200672</b>		Printed 4/24/2014				

Minnesota Unique Well No.		County		Dakota		MINNESOTA DEPARTMENT OF HEALTH		Entry Date		10/19/1990		
<b>200668</b>		Quad		St Paul East		<b>WELL AND BORING RECORD</b>		Update Date		03/06/2014		
		Quad ID		103A		Minnesota Statutes Chapter 1031		Received Date				
Well Name	Township	Range	Dir	Section	Subsections	Use	Depth Drilled	Depth Completed	Date Completed	Lic/Reg. No.		
SWIFTS	28	22	W	22	DDBAB	Commercial	608 ft.	608 ft.	03/19/1954	27010		
Elevation	705 ft.	Method	7.5 minute topographic map (+/- 5 feet)		Acquifer	Multiple	Depth to Bedrock	102 ft.	Open Hole	- ft.	Static Water Level	38 ft.
Field Located	Minnesota Geological Survey		Location Method		Digitized - scale 1:24,000 or larger (Digitizing Table)		Universal Transverse Mercator (UTM) - NAD83 - Zone 15 - Meters					
Unique No. Verified			Input Source		Minnesota Geological Survey		UTM Easting (X) 497793 UTM Northing (Y) 4971168					
Geologic Interpretation			Input Date		01/01/1990		Interpretation Method					
		Agency (interpretation)										
			DEPTH (ft.)		ELEVATION							
Geological Material	Color	Hardness	From	To	Thickness	From	To	Stratigraphy	Primary Lithology	Secondary Lithology	Minor Lithology	
SURFACE SAND			0	7	7	705	698	Quaternary deposit	Sand			
SAND AND CLAY			7	70	63	698	635	Quaternary deposit	Sand	Clay		
SAND AND CLAY			70	82	12	635	623	Quaternary deposit	Sand	Clay		
SAND	BROWN		82	102	20	623	603	Quaternary deposit	Sand			
LIMESTONE			102	167	65	603	538	Prairie Du Chien Group	Dolomite			
SANDSTONE			167	295	128	538	410	Jordan Sandstone	Sandstone			
SANDY SHALE	GREEN		295	458	163	410	247	St. Lawrence Formation	Shale			
SANDY SHALE AND SANDSTONE			458	498	40	247	207	Ironton-Galesville	Shale			
CLAY SHALE	GRAY		498	561	63	207	144	Eau Claire Formation	Shale			
SHALE SANDY	GREEN		561	592	31	144	113	Franconia	Shale			
SANDY SHALE	GRAY		592	608	16	113	97	Eau Claire Formation	Sandstone			
County Well Index Online Well Stratigraphy Report						<b>200668</b>		Printed 4/24/2014				

Minnesota Unique Well No.		County		Dakota		Entry Date		10/19/1990			
<b>200670</b>		Quad		St Paul East		Update Date		03/06/2014			
		Quad ID		103A		Received Date					
MINNESOTA DEPARTMENT OF HEALTH <b>WELL AND BORING RECORD</b> <i>Minnesota Statutes Chapter 1031</i>											
Well Name	Township	Range	Dir	Section	Subsections	Use	Depth Drilled	Depth Completed	Date Completed	Lic/Reg. No.	
VAN HOUEN CO.	28	22	W	26	BCABAB	Abandoned	139 ft.	139 ft.	03/26/1962	27010	
Elevation	700 ft.	Method	7.5 minute topographic map (+/- 5 feet)			Aquifer	Multiple	Depth to Bedrock	137 ft.	Open Hole - ft.	Static Water Level 21 ft.
Field Located	Minnesota	Location Method	Digitized - scale 1:24,000 or larger (Digitizing Table)			Universal Transverse Mercator (UTM) - NAD83 - Zone 15 - Meters					
Geological Survey		Input Source	Minnesota Geological Survey			UTM Easting (X) 498352					
Unique No. Verified		Input Date	01/01/1990			UTM Northing (Y) 4970392					
Geologic Interpretation	Bruce Bloomgren	Agency (interpotation)	Minnesota Geological Survey			Interpotation Method Geologic study 1:24k to 1:100k					
<b>DEPTH (ft.)                      ELEVATION</b>											
Geological Material	Color	Hardness	From	To	Thickness	From	To	Stratigraphy	Primary Lithology	Secondary Lithology	Minor Lithology
FILL			0	10	10	700	690	man-made fill	Fill		
SAND & GRAVEL			10	13	3	690	687	sand +larger	Sand	Gravel	
CLAY			13	17	4	687	683	clay	Clay		
SAND, GRAVEL & SEA SHELL			17	45	28	683	655	sand +larger	Sand	Gravel	
CLAY (STREAKS OF CLAY)			45	103	58	655	597	clay	Clay		
FINE SAND			103	107	4	597	593	sand	Sand		
CLAY (STREAK OF SAND)			107	123	16	593	577	clay	Clay		
SAND & GRAVEL			123	137	14	577	563	sand +larger	Sand	Gravel	
LIMESTONE			137	139	2	563	561	Prairie Du Chien Group	Dolomite		
County Well Index Online Well Stratigraphy Report						<b>200670</b>		Printed 4/24/2014			

## **Appendix A4: Hydraulic System Modeling**

Hydraulic models of the distribution system from the communities within the Southeast Metro Study Area were provided by the communities to be used for this study. The models were used to perform a preliminary analysis of sub-regional water distribution strategies, and to identify infrastructure needs to support surface water supply scenarios. Modified pumping conditions associated with the scenarios were modeled using the Metro Model 3 regional groundwater model to evaluate the aquifer response to alternative water source development.

All of the models provided with the exception of the model from the City of Burnsville were provided in Bentley's WaterGEMS format. The model for the City of Burnsville was provided in Innowyze's InfoWater format. All of the provided models were also assumed to be well calibrated models and no changes were made to the models. In order to evaluate the ability to transfer water between systems through existing interconnects, as well as locate possible future interconnects, the models were all combined into a single integrated hydraulic model using Bentley's WaterGEMS V8i SELECTSeries 4. Figure A4-1 shows the existing distribution system layout for the study area.

To compare different approaches to sub-regional water supply, two approaches were evaluated using the combined hydraulic model for the study area. An analysis of interconnected systems was done to evaluate the potential to supply water to the study area using a combined or interconnected system that would transmit water, in large part, through the existing distribution systems. A second approach, where water would be treated near the raw water source, and then transmitted to the systems within the study area through new dedicated service lines was also evaluated. A description of these approaches and results of the evaluation is described in more detail in the following sections.

### **INTERCONNECTED SYSTEM ANALYSIS**

An analysis was performed to evaluate the feasibility of connecting existing distribution systems within the study area using the existing pipe networks. In this approach, existing interconnects, as well as proposed interconnects were used to provide sub-regional supply. The preliminary analysis revealed several limitations associated with this approach

The distribution systems in the Southeast Metro Study area have been developed around groundwater supply. Although many of the communities have centralized treatment plants, most were developed around individual groundwater wells or clusters of wells. The distribution systems expanded from the wells or central treatment plants with the largest diameter mains located near the wellhouses or treatment plants, and smaller diameter pipe toward the edges of the developed areas. As a result, many of the cities do not have a pipe network of large-diameter trunk mains running close the boundaries with other communities. Instead they have distribution mains typically 12 to 24 inches in diameter extending from the wellhouses. Some exceptions exist, including Apple Valley where the system storage is located near the system boundaries and Eagan where the southern treatment plant is located near the boundary with Apple Valley's system. Also, Inver Grove Heights and South St. Paul share a long border and many 12 to 16 inch mains in Inver Grove Heights are near the border. There are also two storage tanks in South St Paul that are near the border with Inver Grove Heights, so there could be an opportunity to fill them and supply South St. Paul from Inver Grove Heights.



All of the communities have existing emergency interconnects with at least one other community, but they are only designed to be used in an emergency. A majority of the interconnections in the study area are through small 6-inch diameter pipes. The largest interconnections are 12-inches in diameter, which connect Farmington to Lakeville, and Burnsville to Lakeville and Apple Valley. A 12-inch pipe is able to convey 2.5 mgd of flow at a velocity of 5 ft/sec, a common design velocity. The size of the interconnections limits the capacity of the existing systems to transfer significant amount of water between the systems.

A single scenario was evaluated to compare the infrastructure improvements needed to supply water from Eagan to Apple Valley using the existing hydraulic models provided by the communities. The scenario evaluated assumed water would be available at the location of Eagan's existing southern treatment plant and both Apple Valley and Eagan would be supplied from that location. The demands from the existing distribution system models were scaled up to 36.1 mgd for Eagan and 21.2 mgd for Apple Valley, to reflect projected 2040 demands for both communities. This scenario was chosen because there are relatively large mains near the southern edge of Eagan that are in relative close proximity to large mains in the northern section of Apple Valley.

In order to supply water from Eagan to Apple Valley two interconnection locations were identified by finding locations where the large mains in both systems were relatively close to each other and would allow for the water transfer. The first connection identified was from Eagan's southern treatment plant south to the Valleywood Reservoir in Apple Valley. This connection could be used to supply Apple Valley's large lower pressure zone. The second location was a connection from the Safari Reservoir in Eagan south along Galaxie Ave to a 16-inch main under Galaxie Avenue in Apple Valley. A pump would need to be installed at this connection in order to supply Apple Valley's high pressure zone.

There were three main issues identified with this approach. The first issue was the limited ability of the Eagan system to supply water to Apple Valley through existing infrastructure. Eagan's pipes were sized to supply local demands and although the existing infrastructure does have extra capacity in areas, there isn't enough extra capacity to supply all of Apple Valley's demands. The interconnection from the treatment plant would not require any modifications to Eagan's existing system other than some upgrades to the piping configuration in the immediate vicinity of the treatment plant. The second interconnection from Eagan's Safari Reservoir currently only has capacity to move water in and out of the reservoir and was not sized to supply Apple Valley. The entire 24-inch main is approximately 2.9 miles long and would need to be replaced in order to convey the proposed flows used to supply Eagan future demands and the additional flow to supply Apple Valley. The size of the new line would change depending on the amount of water that would need to be supplied across the interconnection.

The second issue is conveying the water through the interconnection to all of Apple Valley. The Apple Valley distribution system was designed to supply water from a central location within the city, and is not set up to move water from the edges inward. There are larger diameter pipes close to the central treatment plant, but the pipes decrease in size further from the plant. Approximately 2.2 miles of 16 inch pipe would need to be replaced and upsized in order to convey the supply from the edge of Apple Valley at the first interconnect location to a location that can supply the rest of Apple Valley.

The third issue has to do with operations of the existing storage within Apple Valley. The existing storage tanks were located to be supplied from the center of Apple Valley and the four (4) tanks within the lower pressure zone are all designed to set the same HGL through the zone. If the location of the supply for the zone was to change to the northern portion of the zone, it would be difficult to fill the tanks in the south of the zone. The available storage for the zone could be reduced due to the modified supply location. At the same time, other tanks could experience water quality (water age) issues due to the elevated zone HGL.

Other issues were identified with the approach of using interconnects to supply the different communities. All of the existing systems have tanks designed to serve the system at a hydraulic grade range based on the operating range of the tank. The connections between the two systems would need to be controlled by either pumps where the hydraulic grade increases or pressure reducing valves where the hydraulic grade decreases.

In this analysis, at least 5.1 miles of new large-diameter distribution mains would need to be installed. Building the new interconnect would add an additional 2.3 miles of new pipes. A dedicated line from Eagan's treatment plant to Apple Valley's treatment plant would be approximately 4.3 miles long. This analysis showed that distributing treated water to supply each system at a current supply point might be more efficient than trying to provide water through existing interconnected systems, which would require extensive modifications and new pipes.

The best opportunity to use the existing system and interconnections was identified between Inver Grove Heights and South St. Paul. Inver Grove Heights is at a higher hydraulic grade and has large distribution mains near the boundary with South St. Paul. South St. Paul has a high zone completely supplied by pumps with no storage and could instead be supplied by Inver Grove Heights.

#### **DEDICATED TRANSMISSION MAIN ANALYSIS**

An analysis was done to determine the feasibility of creating a dedicated transmission main system to supply all of the communities from either a Mississippi River source, or a Minnesota River Source. The dedicated transmission mains were assumed to convey water from either of the surface water sources to existing supply points within each community. Providing treated water to the central supply points was chosen because the existing distribution systems were designed to convey water from these locations.

Pipe segments modeled in the analysis are described in Tables A4-1 and A4-2. These segment routes were common in all dedicated transmission main analyses. Diameter and flow were modeled for each supply scenario.

**Table A4-1. Drinking Water Supply Scenarios – Minnesota River Segments.**

Segment #	Segment Description
Minn - 1	Minnesota River Treatment Plant to Eagan North
Minn - 2	Eagan North to Inver Grove Heights
Minn - 3	Minnesota River Water Treatment Plant to the junction between Eagan South, Burnsville and Apple Valley
Minn - 4	Eagan South, Burnsville and Apple Valley Junction to Burnsville Treatment Plant
Minn - 5	Eagan South, Burnsville and Apple Valley Junction to Eagan South Treatment Plant
Minn - 6	Eagan South, Burnsville and Apple Valley Junction to the Apple Valley and Lakeville Junction
Minn - 7	Apple Valley and Lakeville Junction to Apple Valley Treatment Plant
Minn - 8	Apple Valley to Rosemount Planned Treatment Plant
Minn - 9	Apple Valley and Lakeville Junction to the Lakeville and Farmington Junction
Minn - 10	Lakeville and Farmington Junction to Lakeville Treatment Plant
Minn - 11	Lakeville and Farmington Junction to Farmington Planned Treatment Plant

**Table A4-2. Water Supply Scenarios – Mississippi River Segments**

Segment #	Segment Description
Miss - 1	Mississippi River Treatment Plant to junction between Inver Grove Heights and Eagan
Miss - 2	Inver Grove Heights and Eagan Junction to Inver Grove Heights Treatment Plant
Miss - 3	Inver Grove Heights and Eagan Junction to Eagan and Rosemount Junction
Miss - 4	Eagan and Rosemount Junction to Eagan South Plant
Miss - 5	Eagan South Plant to Eagan North Treatment Plant
Miss - 6	Eagan South Plant to Burnsville Treatment Plant
Miss - 7	Eagan and Rosemount Junction to Rosemount and Apple Valley Junction
Miss - 8	Rosemount and Apple Valley Junction to Rosemount Planned Treatment Plant
Miss - 9	Rosemount and Apple Valley Junction to Apple Valley and Lakeville Junction
Miss - 10	Apple Valley and Lakeville Junction to Apple Valley Treatment Plant
Miss - 11	Apple Valley and Lakeville Junction to Lakeville and Farmington Junction
Miss - 12	Lakeville and Farmington Junction to Lakeville Treatment Plant
Miss - 13	Lakeville and Farmington Junction to Farmington Planned Treatment Plant

Eagan has two treatment plants that supply separate pressure zones. The northern treatment plant supplies the lower zone and the southern treatment plant supplies the higher zone. Based on the provided model, one third of the supply for Eagan comes from the northern treatment plant and two thirds comes from the southern treatment plant. Three of the communities within the study area, South St. Paul, Farmington and Rosemount do not have a central treatment plant. Farmington and Rosemount both have future treatment plants proposed and these locations were used as the supply point.

South St. Paul was assumed to be supplied by Inver Grove Heights in all scenarios because of the advantages identified in the interconnect analysis.

Pumping flows to the existing and planned treatment plant locations would require some modification to the existing utilities. The pipe configuration at the treatment plant locations would need to be modified to accept water from the transmission system, and in some cases a new pump station might be needed to push the new supply into the distribution system. Modifications to the individual city distribution systems, including watermain, pumping, or storage requirements were not examined in the analysis. It was assumed that these improvements would be implemented by the individual cities to meet demand, pressure, and fire-flow requirements to maintain service to water customers, regardless of source.

The analysis assumes that water will be pumped from one of the proposed surface water treatment plants to the different communities. To control the flow to each community, a control valve will need to be installed for each community.

Transmission main requirements associated with each of these scenarios were identified and are summarized in tables with the scenario evaluation. Criteria for transmission main designs were preliminary sized by assuming a maximum allowable velocity of 5 ft/sec to convey average day demands and 8 ft/sec to convey maximum day demands. The scenarios assume a tank will be built at the end of each transmission main and then pumped from the tank to the distribution system. The tank is assumed to be ground storage tanks at the location of the treatment plant and will not be able to supply the system by gravity. Additional pumping and energy will be required to boost the water from the tank to the systems required hydraulic grade. The cost and energy required for the additional pumping required would be offset by reduced pumping required at the existing groundwater wells and treatment plant.

In order to size the transmission mains to supply Eagan in several of the scenarios, the flow was split to the two existing treatment plant locations. The flow was split based on the existing ratio of flows at the two treatment plants. The existing system was not designed to be supplied at a single location. There are not enough pumps to boost the water from the lower pressure zone to the higher pressure zone. There are pressure reducing valves that connect the higher zone to the lower zone, but the pipes connecting the zones are not large enough to completely supply the system. The two connection points for Eagan was assumed to be maintained, so additional modifications would not be required for Eagan system.

The pump size required at the new treatment plants were sized by modeling the proposed transmission system using the Innovyze InfoWater V10.0 Update No.7 modeling software. The scenarios were modeled by assuming water was pumped from a fixed elevation at the treatment plant to storage tanks at all of the different communities with flow control valves to control the amount of water delivered to each community. To model the communities, the water surface elevation was assumed at the ground elevation to represent ground storage tanks at the connection point. A Hazen-Williams C-factor of 130 was assumed to model the roughness for all new transmission mains. For the Minnesota River Scenarios, there were two separate pump stations modeled.

One pump station would supply water to the northern Eagan treatment plant, Inver Grove Heights and South St. Paul and the second pump station would supply water to the rest of the communities south of the treatment plant.

#### **CONSIDERATION FOR IMPLEMENTATION OF WATER SUPPLY SCENARIOS**

The transmission mains were sized based on a hydraulic analysis to limit the water velocity in the transmission main. The alignments for the transmission mains were chosen to minimize new pipe lengths and to locate the mains near major roads, where possible. Should any of these scenarios move forward to implementation, additional analysis and considerations should be incorporated into final pipe, pump station and associated tank sizing and alignment of the infrastructure.

A major cost associated with any transmission main project is the cost of energy associated with pumping water. This cost can be a significant cost over the life of the project and should be considered when evaluating a transmission system. The annual energy costs can be calculated by calculating the total needed pump head (static system head difference plus headloss in the transmission main), converting it to an energy cost and factoring in the efficiency of the system as well as how often the flow will be needed. The final pipe design should factor in these costs and compare the extra energy cost to the cost of a smaller pipe or reduced energy cost to the cost of a larger pipe size.

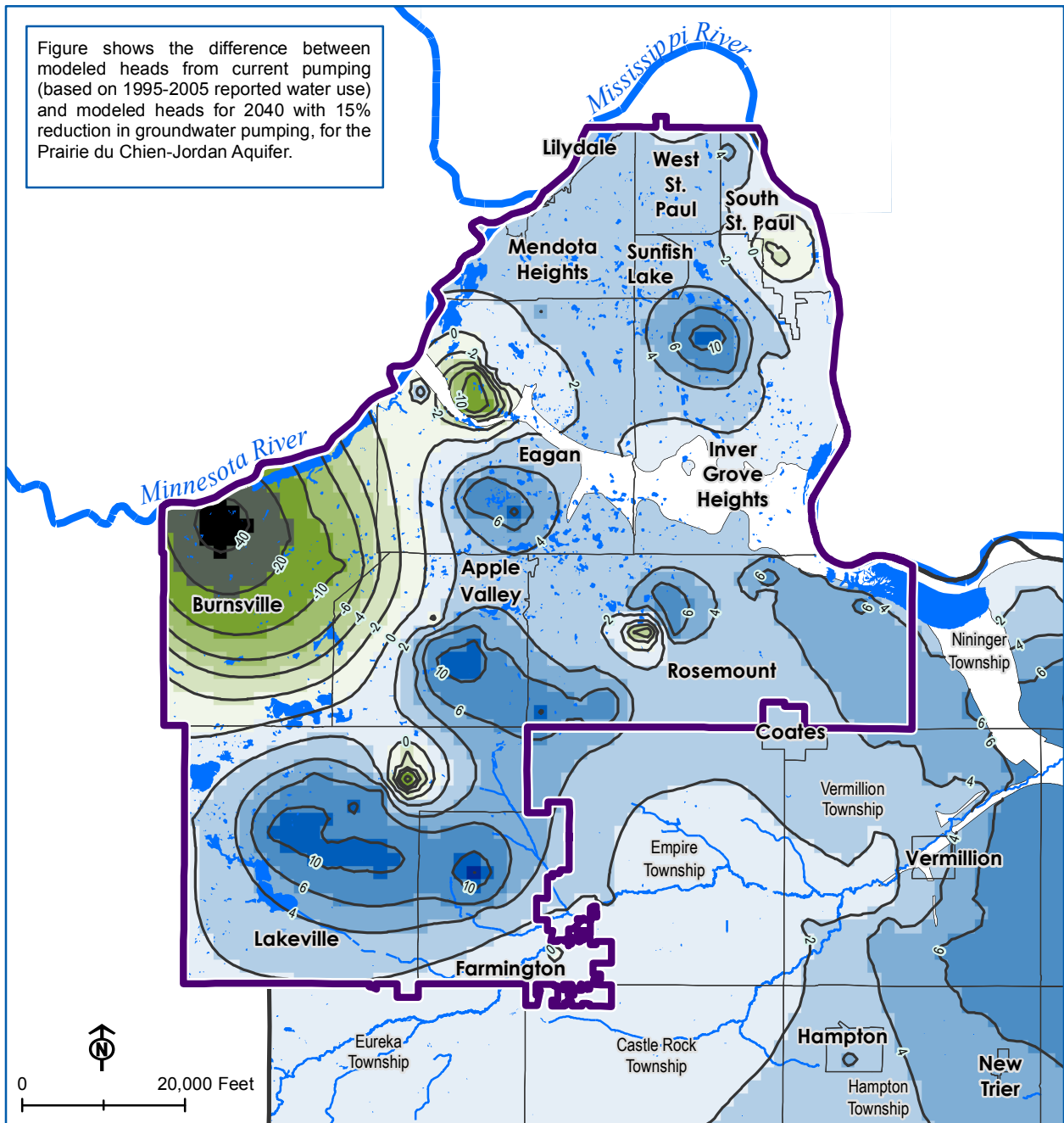
To control the flow to each community, control valves might be used to control the flow in each transmission line. The control valve works by changing the headloss at the valve in order to modify the flow through the valve and these valves can be a large loss of energy. As an alternative to using control valves, it may be feasible to use turbines to control the flow to each community in order to recover some of the energy used in pumping at the treatment plant and make the system more energy efficient.

The scenarios described in the transmission main analysis section are not the only scenarios that are possible with the different supply options from the two treatment plant locations. The scenarios can also be combined and both treatment plants could be built. An example of this would be to build a 17 MGD treatment plant along the Mississippi River that would supply the maximum day demand to Inver Grove Heights and South St. Paul and a 40 MGD treatment plant to supply the maximum day demand to the southern half of Eagan, Apple Valley and Rosemount. This option would convert these communities off of groundwater and completely on to surface water.

**Appendix A5: Demand Reduction Scenarios**



Figure shows the difference between modeled heads from current pumping (based on 1995-2005 reported water use) and modeled heads for 2040 with 15% reduction in groundwater pumping, for the Prairie du Chien-Jordan Aquifer.



Legend	
<b>Drawdown (ft)</b>	<b>Recovery (ft)</b>
0 - 2	40+
2 - 4	20 - 40
4 - 6	10 - 20
6 - 10	6 - 10
10 - 20	4 - 6
20 - 40	2 - 4
40+	0 - 2
—	— Drawdown/Recovery Contour
□	□ Prairie du Chien and Jordan Absent
□	□ Study Area
□	□ County Boundary
□	□ City/Township Boundary
~	~ Perennial Stream
☪	☪ Waterbody

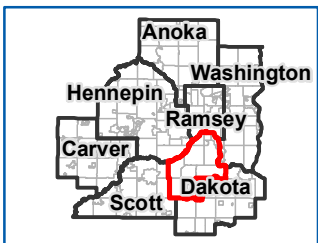
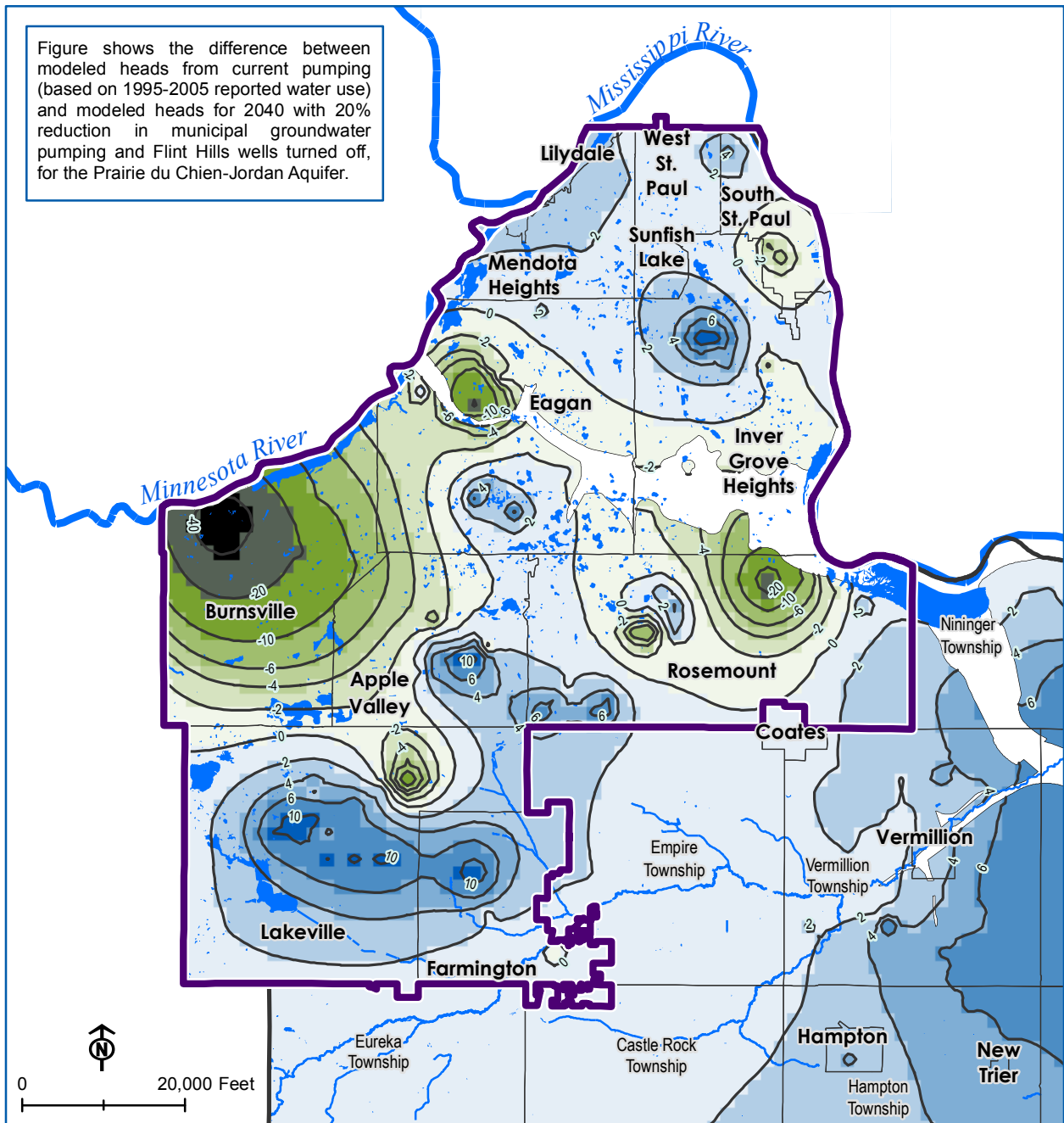
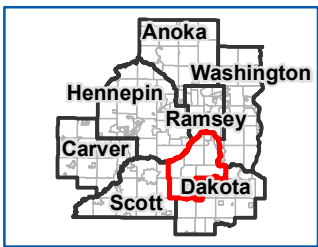




Figure shows the difference between modeled heads from current pumping (based on 1995-2005 reported water use) and modeled heads for 2040 with 20% reduction in municipal groundwater pumping and Flint Hills wells turned off, for the Prairie du Chien-Jordan Aquifer.



Legend		
<b>Drawdown (ft)</b>	<b>Recovery (ft)</b>	— Drawdown/Recovery Contour
0 - 2	40+	□ Prairie du Chien and Jordan Absent
2 - 4	20 - 40	▭ Study Area
4 - 6	10 - 20	▭ County Boundary
6 - 10	6 - 10	▭ City/Township Boundary
10 - 20	4 - 6	— Perennial Stream
20 - 40	2 - 4	— Waterbody
40+	0 - 2	



Sources: Met Council, NHD, DNR

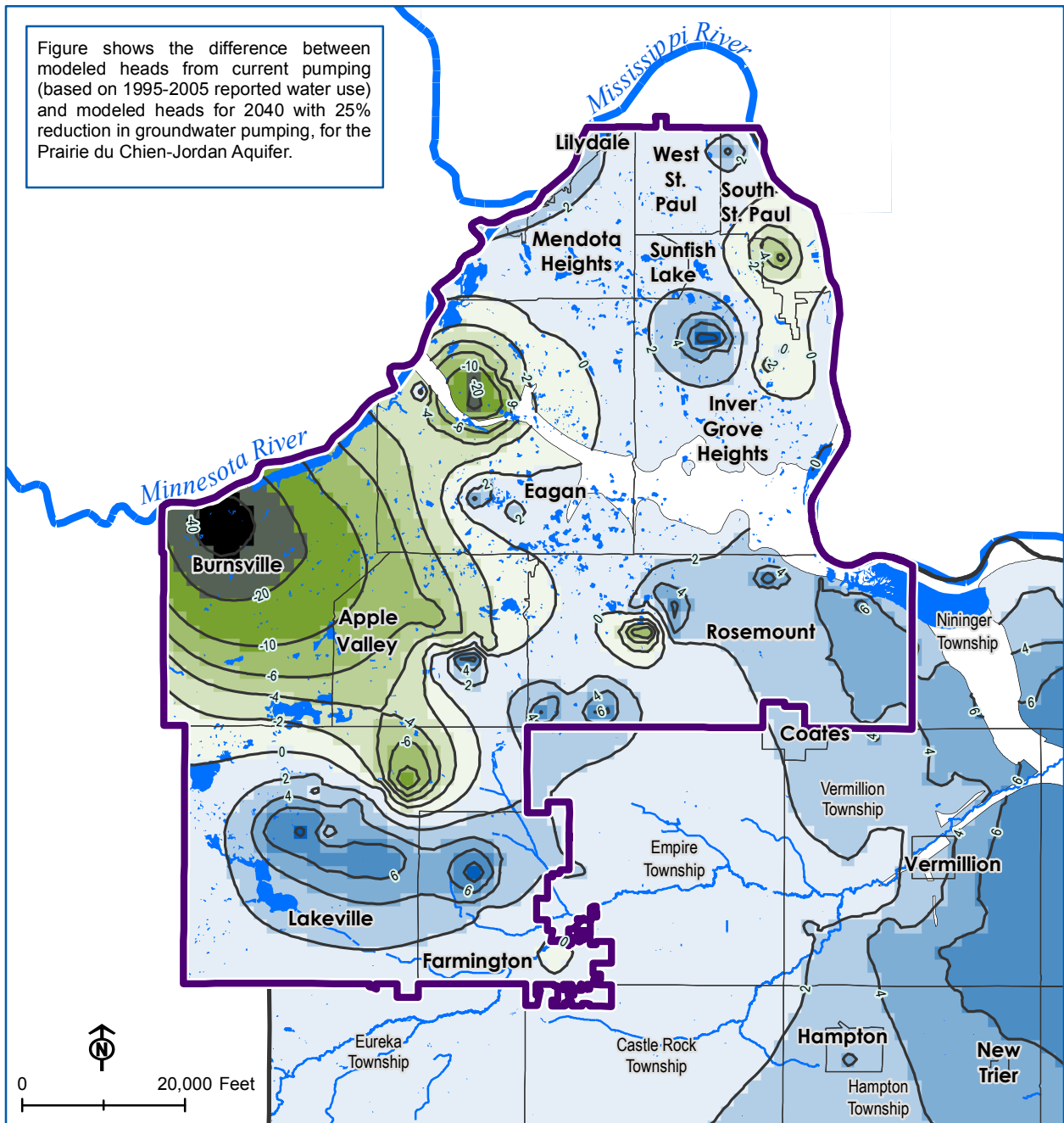
Document Path: \\mspe-gis-file\gisproj\MetCouncil\224209\map\_docs\Southeast\_Region\A5-02\_FHoff\_2040\_Drawdown\_8x11P.mxd



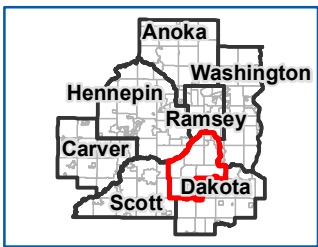




Figure shows the difference between modeled heads from current pumping (based on 1995-2005 reported water use) and modeled heads for 2040 with 25% reduction in groundwater pumping, for the Prairie du Chien-Jordan Aquifer.



Legend	
<b>Drawdown (ft)</b>	<b>Recovery (ft)</b>
0 - 2	40+
2 - 4	20 - 40
4 - 6	10 - 20
6 - 10	6 - 10
10 - 20	4 - 6
20 - 40	2 - 4
40+	0 - 2
—	— Drawdown/Recovery Contour
□	□ Prairie du Chien and Jordan Absent
▭	▭ Study Area
▭	▭ County Boundary
▭	▭ City/Township Boundary
~	~ Perennial Stream
☪	☪ Waterbody



Sources: Met Council, NHD, DNR

Document Path: \\mspe-gis-file\gisproj\MetCouncil\224209\map\_docs\Southeast\_Region\A5-03\_25pct\_Reduction\_8x11P.mxd

## **Appendix A6: Cost Estimating**

### **COST ESTIMATING ASSUMPTIONS**

Inherently, capital cost estimates will vary depending on the phase of the project when they are developed, which determines the level of detail and the expected accuracy of the estimate. The Association for the Advancement of Cost Engineering International (AACE International) Recommended Practices, specifically Document No. 18R-97 outlines typical cost estimate accuracies based on the overall status of the project. The cost estimates for the Regional Feasibility Assessments should be considered Project Definition (Estimate Classification 5) level estimates with an expected accuracy of +100 to -50 percent (+100%/-50%).

The total project cost necessary to complete a project consists of expenditures for capital construction costs, engineering and environmental services, land acquisition, contingencies, and overhead items such as legal, administrative and financing services.

Construction costs cover the material, equipment, labor and services necessary to build the proposed project. Prices used in this study are obtained from a review of other consultant cost estimates, Council correspondence, and other sources of construction cost information. Construction costs used in this report are not intended to represent the lowest prices which may be achieved but rather are intended to represent a median of competitive prices submitted by responsible bidders.

Such factors as unexpected construction conditions, the need for unforeseen mechanical and electrical equipment, and variations in final quantities are a few examples of items that can add to planning level estimates of project cost. To cover such contingencies, an allowance of thirty percent (30%) of the construction cost has been included.

Engineering services may include preliminary investigations and reports, geotechnical and foundation explorations, preparation of design drawings and specifications, engineering services during construction, construction observation, construction surveying, sampling and testing, start-up services, and preparation of operation and maintenance manuals. Overhead charges cover such items as legal fees, financing fees, and administrative costs. The costs presented in this report include a twenty percent (20%) allowance for engineering services, legal, and administrative costs. The engineering, legal, and administrative costs are added to the construction plus construction contingency values. Land acquisition, survey, environmental and archaeology studies and mitigation activities are added on top of the contingencies and engineering, legal and administrative costs.

The cost estimates prepared in this report are estimated in 2013-14 dollars. Future changes in the cost of materials, equipment and labor will cause significant changes in project costs. A good indicator of changes in construction costs is the Engineering News-Record (ENR) Construction Cost Index (CCI), which is computed from prices of construction material and labor.

Cost data in this report are based on an ENR CCI (Minneapolis) of 10970, which is the value for years 2013-14 (though May of 2014). Cost data presented in this report can be adjusted to any time in the past or future by factoring it by the ratio of the then prevailing ENR CCI (Minneapolis) divided by 10970.

Final cost estimates will vary from the planning level cost estimates depending on actual labor and material costs, competitive market conditions, final project scope, implementation schedule and other variable factors that are difficult to forecast. Project feasibility and funding needs must be carefully reviewed prior to making specific financial decisions regarding the capital improvements.

Debt service for financing includes the annual interest rate per year and length of a loan. To calculate the annual amount owed on a project loan an interest rate of 4% was applied to estimate debt service over a 20 year payback period.

Assumptions used in the cost estimates are summarized in Table A6-1.

**Table A6-1: Cost Estimating Assumptions**

<b>Cost</b>	<b>Unit</b>	<b>Unit Description</b>
<b>Contingencies</b>		
Design	30%	of capital costs
Engineering, Administration, and Legal	20%	of capital costs and design contingencies
<b>Operations and Maintenance</b>		
Pipelines	1%	of total cost
Pump Stations and Storage Tanks	3%	of total cost
Water Treatment Plants	12%	of total costs
<b>Right-of-Way Acquisition (Pipelines)</b>		
Permanent ROW Easement	25 ft	
Unit Land Cost	\$261,360 / acre	of ROW area
<b>Land Acquisition (Pump Stations, Storage Tanks and Treatment)</b>		
Pump Station Sites	3 acre	per pump station
Storage Tank Sites	1 acre	per pump station
Treatment Plant Areas	0.5 acre	per MGD of treatment

<b>Cost</b>	<b>Unit</b>	<b>Unit Description</b>
Unit Land Cost	\$435,600 / acre	of land area
<b>Surveying</b>		
All Facilities	10%	of ROW or land acquisition costs
<b>Environmental &amp; Archaeology Studies and Mitigation</b>		
Pipelines	\$50,000	per mile
Pump Stations, Storage Tanks and Treatment	30%	of land acquisition costs
<b>Miscellaneous</b>		
SCADA and Control Systems (Integration)	1%	of total capacity costs
<b>Debt Service</b>		
Interest Rate	4%	per year
Debt Service Period	20	years
<b>Construction Loan</b>		
Loan Rate	4%	
Rate of Return on Investments	4%	
Duration of Construction	4	years
<b>MnDNR Water Use Fee Rates</b>		
Fee (Volume Appropriated Above 500 Million Gallons per Year)	\$8.00	per MG

## UNIT COSTS

The following unit costs were developed to establish feasibility-level cost estimates for comparing regional system alternatives.

## PIPELINES

Pipeline unit costs are developed based on dollars per foot and the pipe diameter. The average cost across all pipe sizes is \$13.69 per inch diameter-foot. The majority of installation conditions are assumed to be in soil urban (paved) conditions. Unit costs shown in Table A6-2 are adjusted slightly based on estimated pipe class based on hydraulic modeling. Adjustment factors are listed in Table A6-3.

**Table A6-2. Pipe Unit Costs**

<b>Diameter (in)</b>	<b>\$/ft</b>
12	98
16	164
18	197
20	228
24	293
30	390
36	486
42	582
48	681
54	777
60	874
66	1021
72	1196
78	1399
87	1637

**Table A6-3. Unit Cost Adjustment Factors for Pipe Classes**

<b>Pipe Class</b>	<b>Adjustment Factor</b>
100	0.92
150	1.00
200	1.08
250	1.16
300	1.24
350	1.32

**PUMP STATIONS AND INTAKES**

Pump station unit costs are based on brake horsepower (BHP) required. The average cost across all pump station brake BHP values is \$8,640 per BHP. Power connection costs are added to unit costs at a price of \$300 per BHP. Intake costs are based on the total horsepower required for the intake pump station. The average cost across all intake BHP values is \$4,510 per BHP. A 70 percent efficiency was used for BHP calculations. Pump station unit costs are listed in Table A6-4. Surface water intake station unit costs are listed in Table A6-5.

**Table A6-4. Pump Station Unit Costs**

<b>BHP</b>	<b>\$-millions</b>
100	1.79
200	3.60
300	3.96
400	5.04
500	5.16
600	5.30
700	5.44
800	6.41
900	6.65
1,000	6.90
2,000	9.34
3,000	11.79
4,000	14.24
5,000	16.69
6,000	19.13
7,000	21.58
8,000	24.03
9,000	26.48
10,000	28.92
20,000	53.40

**Table A6-5. Surface Water Intake Unit Costs**

<b>BHP</b>	<b>\$-millions</b>
100	1.55
200	1.58
300	1.61
400	1.66
500	2.63
600	3.60
700	4.57
800	4.72
900	5.58
1,000	6.45
2,000	9.34

**WATER TREATMENT PLANT INCLUDING INTAKE AND CLEARWELL STORAGE**

Water treatment plant costs are based on peak treatment capacity. The average cost across all treatment capacities is \$3.00 per MGD. This study assumed a typical lime softening treatment process would be appropriate for treating the potential surface water sources for the study area. The process includes chemical addition, rapid mix, flocculation, settling, filtration, and disinfection with chlorine or similar disinfectant. Intake and clearwell storage costs are based on terminal storage costs by acre-ft. Unit cost assumptions are listed in Table A6-6 and A6-7.

**Table A6-6. Water Treatment Plant Unit Costs**

<b>Capacity (MGD)</b>	<b>\$-millions</b>
10	35.3
50	145
75	213
100	280
150	412

**Table A6-7. Intake and Clearwell Storage Unit Costs**

<b>Capacity (acre-ft)</b>	<b>\$-millions</b>
50	4.14
100	6.91

**STORAGE TANKS AND CONTROL-METER VAULTS**

Storage tank costs are based on covered concrete ground storage reservoirs by storage volume. The average cost across all sizes of storage tanks is \$1.24 per gallon. For the terminal storage tanks at each of the customer delivery points in the dedicated transmission main scenarios, the control-meter vaults upstream of the tanks are included in the storage tank costs. Unit cost assumptions for ground storage tanks are listed in Table A6-8.

**Table A6-8. Ground Storage Tank Costs**

<b>Tank Size (MG)</b>	<b>\$-millions</b>
0.5	0.89
1.0	1.51
1.5	2.09
2	2.67
2.5	2.89
3	3.11
3.5	3.56
4	4.00
5	4.45

**COST OF RAW WATER**

The Minnesota Department of Natural Resources (MnDNR) appropriation fee for 500 million gallons per year or higher was applied to all scenarios at \$8.00 per MG.



## Appendix A7: Water Quality Evaluation

### SOURCE WATER QUALITY

River water quality data was obtained from the Water Quality Portal located on the National Water Quality Monitoring Council web site. The Water Quality Portal (WQP) is a cooperative service sponsored by the United States Geological Survey (USGS), the Environmental Protection Agency (EPA) and the National Water Quality Monitoring Council. The data provided on the WQP is a collection of publicly available water quality data from the USGS National Water Information System (NWIS), the EPA STOrage and RETrieval (STORET) Data Warehouse, and the United States Department of Agriculture's ARS Sustaining The Earth's Watersheds – Agricultural Research Database System (STEWARDS). The data used in this analysis includes sampling points along the Mississippi River at St. Paul, and the Minnesota River at Burnsville, Bloomington, Shakopee and Jordan. A summary of the data obtained for both river systems along with a comparison with the Safe Drinking Water Act (SDWA) primary and secondary standards is shown in Table A7-1.

**Table A7-1: Water Quality Summary for Area Communities and the Mississippi and Minnesota River Systems**

Parameter	Units	Primary Drinking Water Standards	Secondary Drinking Water Standards	Mississippi River	Minnesota River
Temperature	Deg C			0 - 30	9.5 - 28
Specific Conductance	uS/cm @25C			300 - 750	600 - 900
pH	pH units		6.5 – 8.5	7.4 - 8.8	7.5 - 8.5
Alkalinity, Total	mg/L as CaCO <sub>3</sub>			130 - 240	210 - 220
Chloride	mg/L		250	7 - 35	5 - 32
Sulfate	mg/L		250	20 - 140	170 - 200
Fluoride	mg/L	4	2	0.1 - 0.3	0.27 - 0.29
Total Hardness	mg/L as CaCO <sub>3</sub>			160 - 340	340
Calcium	mg/L			90 - 210	180
Magnesium	mg/L			40 - 150	65
Iron	ug/L		300	160 - 440	NA
Manganese	ug/L		50	10 - 300	NA
Ammonia	mg/L as N			0.4 - 1.6	0.4 - 1.6
Nitrate	mg/L as N	10		0.0 - 4.7	0.1 - 1.6
Total Organic Carbon	mg/L			5 - 21	5.8 - 16
Total Trihalomethane	ug/L	80		NA	NA
Haloacetic Acid (5)	ug/L	60		NA	NA

**Notes:**

NA – Not analyzed

Data for the Minnesota River is not as complete as the Mississippi River.

In general, the Minnesota River water tends to include higher dissolved solids (as indicated by specific conductance), total and calcium hardness, alkalinity, sulfate and turbidity (suspended solids) than the Mississippi River in this region. However, the differences do not appear to be significant enough require different treatment processes. The variability in reported river water quality is typically seasonal.

#### **SOURCE WATER TREATMENT**

Within the Twin Cities Metropolitan area, there are two large surface water systems that draw from the Mississippi River. Both Minneapolis Water and Saint Paul Regional Water Services systems provide lime softening treatment, followed by varied filtration processes. Minneapolis Water provides conventional gravity filtration at the Fridley Plant and ultrafiltration at the Columbia Heights Water Treatment Plant. Saint Paul Regional Water Services uses conventional gravity filtration with a granular activated carbon (GAC) cap at the McCarron's Water Treatment Plant. Similar processes are used to treat Minnesota River water, although there are no surface water supplies within the Twin Cities Metropolitan Area that use this source. The City of Mankato, located approximately 70 miles upstream of the Twin Cities on the Minnesota River, uses lime softening to treat a blend of Minnesota River and Blue Earth River water supplied through horizontal collector wells.

Lime softening is common practice for source waters with similar water quality to the Mississippi and Minnesota Rivers. The lime softening process removes hardness components from the raw water and is robust enough to provide removal of seasonal raw water turbidity (suspended solids) and provides for some organic carbon removal. For consistency with the region's water treatment practices, and because it is an appropriate treatment scheme for these source waters, lime softening of either the Mississippi River or Minnesota River water is assumed for the water quality evaluation in this study.

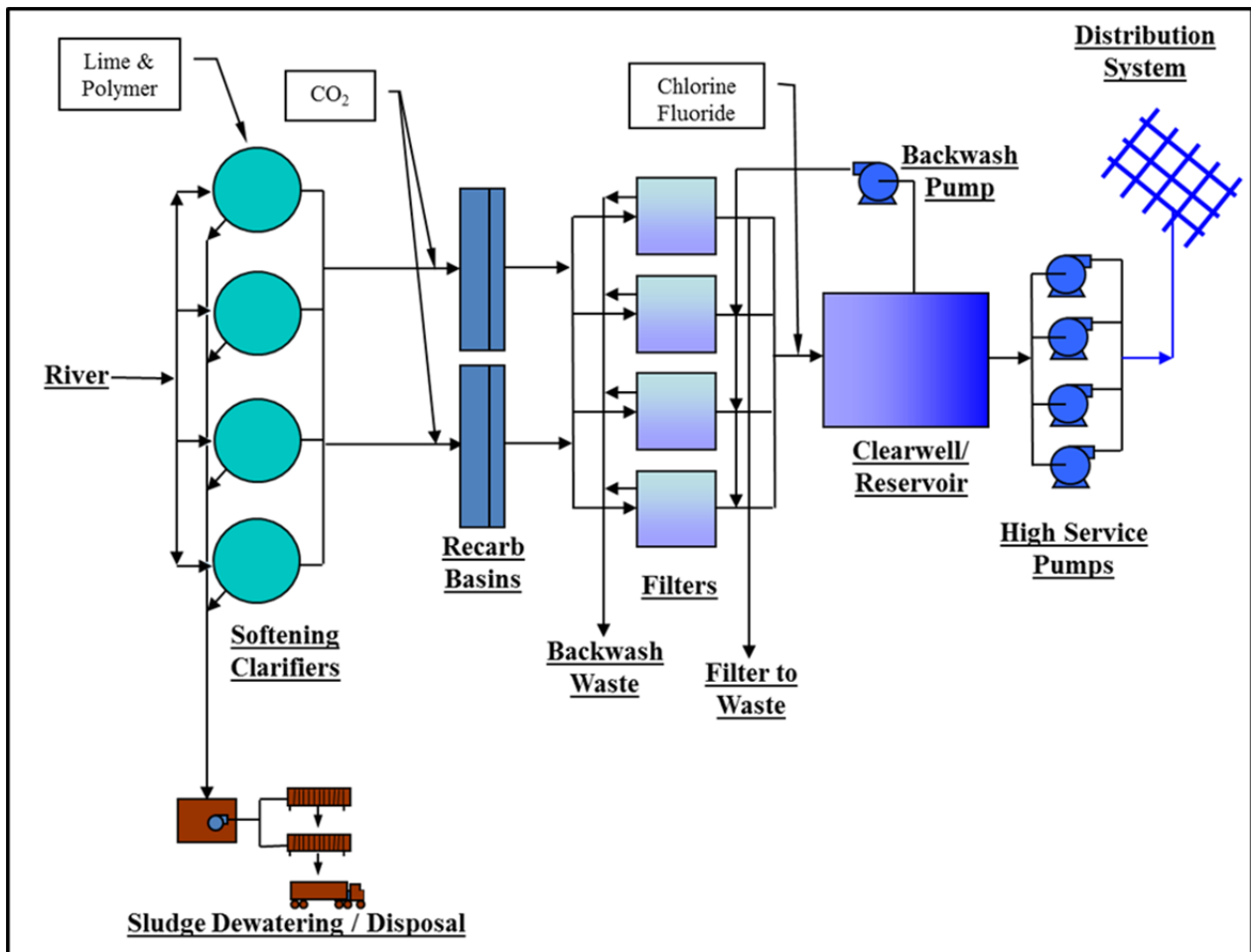
Figure A7-1 is a typical schematic of a lime softening water treatment plant. Treatment processes include softening clarifiers, where lime is applied to precipitate soluble hardness components, recarbonation to adjust the pH of the water, filtration (either gravity or membrane) to remove precipitates, clearwell or reservoir storage, and high service pumping for delivery of the treated water to the distribution system. The size and number of processes are based on the required design flow rate.

Finished water from a lime softening water treatment plant on the Mississippi River or the Minnesota River would be of similar quality and chemical composition to the water supplied from either Minneapolis Water or Saint Paul Regional Water Services. Both of these large water supply systems meet the Minnesota Department of Health and US Environmental Protection Agency drinking water standards.<sup>1</sup>

---

<sup>1</sup> 2013 Water Quality Report, City of Minneapolis, Minnesota,  
<http://www.minneapolismn.gov/www/groups/public/@publicworks/documents/webcontent/wcms1p-125811.pdf>

Figure A7-1. Typical Lime Softening Water Treatment Plant Schematic



#### EXISTING SYSTEM WATER SUPPLY AND TREATMENT PRACTICES

The communities within the Southeast Metro Study Area currently provide drinking water to their customers through independent, municipally-owned and operated water systems<sup>2</sup>. The majority of the study area is served by groundwater, with the exception of Burnsville, which draws a portion of its water supply from the Kraemer Quarry, a combined groundwater and surface water source. A variety of groundwater sources are used in the area, including the Prairie du Chien/Jordan, Mount Simon/Hinckley, and Tunnel City-Wonewoc aquifers. Water treatment practices vary from minimal disinfection, fluoridation and iron sequestration to iron and manganese filtration.

Water Quality Report 2014, Saint Paul Regional Water Services,  
<http://mn-stpaul.civicplus.com/DocumentCenter/Home/View/1333>

<sup>2</sup>The Southeast Metro Study Area covers a portion of northern Dakota County, including the communities of Apple Valley, Burnsville, Eagan, Farmington, Inver Grove Heights, Lakeville, Rosemount, and South St. Paul. Mendota Heights and West St. Paul, north of the study area, were excluded from the alternative water supply analysis because they are currently served by Saint Paul Regional Water Services through long-term water supply contracts. These two communities were, however, included in the stormwater use and enhanced recharge analysis

Burnsville’s treatment process for the quarry water includes direct filtration and meets the requirements of the Surface Water Treatment Rule. Table A7-2 summarizes the current source of supply and treatment practices in the study area.

**Table A7-2 Southeast Metro Study Area Water Supply and Treatment Practices**

<b>Water System</b>	<b>Existing Source of Supply</b>	<b>Existing Treatment</b>
Apple Valley	Groundwater	Iron and Manganese Filtration
Burnsville	Groundwater	Iron and Manganese Filtration
	Surface Water	Direct Filtration
Eagan	Groundwater	Iron and Manganese Filtration
Farmington	Groundwater	Disinfection, Fluoridation
Inver Grove Heights	Groundwater	Iron and Manganese Filtration
Lakeville	Groundwater	Iron and Manganese Filtration
Rosemount	Groundwater	Disinfection, Fluoridation, Sequestration
South St. Paul	Groundwater	Fluoridation

The Minnesota Department of Health provided the operating water quality data for the study area communities. All eight communities in the study area report compliance with the Minnesota Department of Health and US Environmental Protection Agency drinking water standards through their respective Consumer Confidence Reports.

Table A7-3 summarizes the range of finished water quality parameters as measured in the various community distribution systems. The water quality through the various community water systems is considered moderately to high hardness. Table A7-4 summarizes the disinfection byproduct data, also from the distribution systems. Each community meets the required disinfection byproduct requirements.

**Table A7-3. Water System Finished Water Quality**

<b>Parameter</b>	<b>Apple Valley</b>	<b>Burnsville</b>	<b>Eagan</b>	<b>Farmington</b>
pH	6.48 - 8.38	7.4 - 7.8	7.6 - 7.8	7.4 - 8.33
Specific Conductance (uS/cm)	537 - 709	463 - 796	451 - 618	450 - 588
Temperature (°C)	9.5 - 18.23	10.02 - 14.14	9.91 - 14.98	9.43 - 22.95
Calcium (mg/L)	73.7 - 86.1	-	-	62.5 - 77.4
Magnesium (mg/L)	25.9 - 35.2	-	-	24.7 - 26.7
Iron (ug/L)	44.9 - 583	23 - 641	43.1 - 596	337 - 576
Manganese (ug/L)	17.9 - 64.4	48.7 - 165	52.1 - 345	42.9 - 79.3
Alkalinity, Total (mg/L as CaCO <sub>3</sub> )	260 - 290	220 - 310	210 - 300	220 - 270
Chloride (mg/L)	6.98 - 41.6	5.92 - 28	6.58 - 15.7	1.13 - 2.7
Sulfate (mg/L)	2.79 - 32.9	6.47 - 42.1	4.02 - 24	8.34 - 37
Fluoride, Total (mg/L)	0.16 - 1.1	0.21 - 1.1	0.18 - 1.1	0.14 - 1.2
Total Organic Carbon (as C) (mg/L)	1	1.5 - 1.5	1.1 - 1.1	1.2 - 1.2
Calcium Hardness (as CaCO <sub>3</sub> ) (mg/L)	184 - 215			156 - 194
Total Hardness (as CaCO <sub>3</sub> ) (mg/L)	106 - 145			102 - 110

**Table A7-3. Water System Finished Water Quality (cont.)**

<b>Parameter</b>	<b>Inver Grove Heights</b>	<b>Lakeville</b>	<b>Rosemount</b>	<b>South St. Paul</b>
pH	7.5 - 7.5	7.08 - 9.5	7.6 - 7.6	7.2 - 7.3
Specific Conductance (uS/cm)	445 - 545	458 - 655	502 - 580	480 - 910
Temperature (°C)	9.76 - 11.66	9.57 - 25.85	9.37 - 13.29	10.3 - 19.4
Calcium (mg/L)	52 - 72.2	63.9 - 97.7	-	64 - 110
Magnesium (mg/L)	17.7 - 29.1	24.2 - 30.4	-	26.1 - 38.8
Iron (ug/L)	98 - 660	410 - 888	60.1 - 528	0.31 - 0.37
Manganese (ug/L)	252 - 710	35 - 81	32 - 109	28 - 61
Alkalinity, Total (mg/L as CaCO <sub>3</sub> )	210 - 280	240 - 330	240 - 270	250 - 300
Chloride (mg/L)	2.23 - 12.8	0.548 - 1.91	1.64 - 21.1	2.55 - 97.3
Sulfate (mg/L)	3.41 - 14.6	3.57 - 37.1	13.5 - 48.7	6.3 - 31.6
Fluoride, Total (mg/L)	0.32 - 1.1	0.11 - 1	0.12 - 1	0.16 - 1.3
Total Organic Carbon (as C) (mg/L)	1 - 1.1	1.2 - 1.2	-	
Calcium Hardness (as CaCO <sub>3</sub> ) (mg/L)	130 - 181	160 - 244		160 - 275
Total Hardness (as CaCO <sub>3</sub> ) (mg/L)	73 - 120	259 - 369		267 - 434

**Table A7-4. Existing System Disinfection Byproducts**

<b>Water System</b>	<b>Total Trihalomethane (ug/L)</b>	<b>Haloacetic Acid (5) (ug/L)</b>
Apple Valley	12.1 - 23.2	6.3 - 8.2
Burnsville	9.8 - 19.9	6.8 - 8
Eagan	9.4 - 35.8	6.2 - 13.4
Farmington	2.1 - 3.5	6
Inver Grove Heights	5.7 - 25.1	6 - 10.2
Lakeville	19.5 - 19.6	8.1 - 10.6
Rosemount	1.3 - 7.2	6
South St. Paul		

**POTENTIAL IMPACT OF INCORPORATING WATER SUPPLY FROM MISSISSIPPI OR MINNESOTA RIVER SOURCE**

Finished water quality from a Mississippi or Minnesota River source treated with a lime softening process is anticipated to be of similar quality to existing surface water treatment systems, including the water supplied by the Saint Paul Regional Water Services. The water quality for Saint Paul Water from July 2013 through April 2014 is summarized in Table A7-5.

**Table A7-5. Saint Paul Regional Water System Seasonal Finished Water Quality**

<b>Parameter</b>	<b>Jul 2013</b>	<b>Oct 2013</b>	<b>Jan 2014</b>	<b>Apr 2014</b>
pH	9.06	9.05	8.93	9.00
Total Dissolved Solids	193	175	189	203
Temperature (°C)	25	16	4	6
Calcium (mg/L)	29	19	19	19
Magnesium (mg/L)	<0.4	8	11	10
Iron (mg/L)	<0.05	<0.04	<0.05	<0.05
Manganese (mg/L)	<0.05	<0.05	<0.05	<0.09
Alkalinity, Total (mg/L as CaCO <sub>3</sub> )	50	49	58	56
Chloride (mg/L)	3.57	35	33	32
Sulfate (mg/L)	12	<8	12	29
Fluoride, Total (mg/L)	1.11	0.85	1.01	1.07
Total Organic Carbon (mg/L)	3.65	4.01	3.66	3.63
Calcium Hardness (mg/L)	73	48	48	48
Total Hardness (mg/L)	74	79	95	89
Chlorine Residual (mg/L)	3.57	3.57	3.52	3.47

Comparing the representative water quality from the Saint Paul Regional Water Services to the range of finished water quality parameters in the study area, the treated surface water quality is softer and has a higher pH than the water customers in the study area are accustomed. Since water customers become accustomed to their drinking water quality, utilities may experience complaints relating to taste and odor after converting from a groundwater supply to a softened surface water supply. This is primarily due to a change in overall water quality.

The softer water provided to homes and businesses may benefit customers with home water softeners by reducing the amount of salt required to maintain the water softener. Some customers may determine that they no longer require their home water softener. There is potentially an environmental benefit associated with reduced total dissolved solids in wastewater from surface water users. This is a result of reduced salt required for point of use water softeners.

Additionally, a regional water treatment system will need provide secondary disinfection with chloramines, along with converting from free chlorine in the distribution system to chloramine. Prior to making this conversion, utilities will need to notify customers. Most customers should not notice a change in the taste due to chloramines. In fact, many utilities around the country that have made the conversion report chloramine improves the taste and odor of their drinking water. Some increased degradation of rubber plumbing components may result from conversion to chloramination. In addition, the conversion to chloramination can affect specialized water users, including medical facilities.

#### **ISSUES FOR CONJUNCTIVE USE, SURFACE WATER SUPPLEMENTED BY GROUNDWATER**

Conjunctive use of surface water and groundwater in this study area would include base, or average day supply from a sub-regional surface water source supplemented with groundwater supply during peak demand periods. Many of the same issues that were discussed previously for converting to providing water only from the Mississippi River or Minnesota River sources also apply to conjunctive use. This includes the consideration for changing disinfection practices from free chlorine to chloramines. However, for consistency throughout the distribution systems, disinfection practices at the water supply wells would also need to be converted to include an ammonia feed system to provide continuous chloramine disinfection.

Unless the surface water entry point to the distribution system is the same as the groundwater entry point, mixing will not occur uniformly throughout the distribution system. The blend will move through the distribution system as groundwater is introduced. The water quality at this interface will be variable and may be a source of customer complaints ranging from turbid water to taste and odor complaints.

Blending of waters can cause excessive scale or corrosion in metal pipes, including steel, ductile/cast iron and copper, lead and zinc plumbing products. Several calcium carbonate related stability indices are used to describe the corrosion and scaling potential. These include the Langelier Stability Index (LSI), Ryznar Index (RI), and Aggressive Index (AI). These indices are defined as follows:



### **LANGELIER STABILITY INDEX (LSI)**

The Langelier Saturation Index (LI), a measure of a solution's ability to dissolve or deposit calcium carbonate, is often used as an indicator of the corrosivity of water. The index is not related directly to corrosion, but is related to the deposition of a calcium carbonate film or scale; this covering can insulate pipes, boilers and other components of a system from contact with water. When no protective scale is formed, water is considered to be aggressive and corrosion can occur. Highly corrosive water can cause system failures or result in health problems because of dissolved lead and other heavy metals. An excess of scale can also damage water systems, necessitating repair or replacement. Although information obtained from the LI is not quantitative, it can be useful in estimating water treatment requirements for low pressure boilers, cooling towers and water treatment plants, as well as serving as a general indicator of the corrosivity of water.

The LI is a gauge of whether a water will precipitate or dissolve calcium carbonate. If the  $pH_s$  is equal to the actual pH, the water is considered "balanced". This means that calcium carbonate will not be dissolved or precipitated. If the  $pH_s$  is less than the actual pH (the LI is a positive number), the water will tend to deposit calcium carbonate and is scale-forming (nonaggressive). If the  $pH_s$  is greater than the actual pH (the LI is a negative number), the water is not saturated and will dissolve calcium carbonate (aggressive). In summary:

- $pH_s = pH_{\text{actual}}$ , water is balanced
- $pH_s < pH_{\text{actual}}$ , LI = positive number, water is scale forming (nonaggressive)
- $pH_s > pH_{\text{actual}}$ , LI = negative number, water is not scale forming (aggressive)

Because the protective scale formation is dependent on pH, bicarbonate ion, calcium carbonate, dissolved solids and temperature; each may affect the water's corrosive tendencies independently. Soft, low-alkalinity waters with either low or excessively high pH are corrosive, even though this may not be predicted by the LI. This is because insufficient amounts of calcium carbonate and alkalinity are available to form a protective scale. Waters with high pH values and sufficient hardness and alkalinity may also be corrosive, even if the LI predicts the opposite. This is the result of calcium and magnesium complexes that cannot actively participate in the scale forming process. Analytical procedures do not distinguish between these complexes and available calcium and magnesium; therefore, the LI value is not accurate in such situations.

Corrosive tendencies may also be exhibited by water containing high concentrations of sulfate, chloride and other ions which interfere with uniform carbonate film formation. As a result of these and other problems, the LI is useful only for determining the corrosivity of waters containing more than 40 mg/L of alkalinity, sufficient calcium ion concentration and ranging between pH 6.5 and 9.5.

### **RYZNAR INDEX (RI)**

The Ryznar stability index (RSI) attempts to correlate an empirical database of scale thickness observed in municipal water systems to the water chemistry. Like the LSI, the RSI has its basis in the concept of saturation level. Ryznar attempted to quantify the relationship between calcium carbonate saturation state and scale formation.

The empirical correlation of the Ryznar Stability Index can be summarized as follows:

- RSI < 6 the scale tendency increases as the index decreases
- RSI > 7 the calcium carbonate formation probability does not lead to a protective corrosion inhibitor film
- RSI > 8, mild steel corrosion becomes an increasing problem

**AGGRESSIVE INDEX (AI)**

The Aggressive Index (AI), originally developed for monitoring water in asbestos pipe, is sometimes substituted for the Langelier Index as an indicator of the corrosivity of water. The AI is derived from the actual pH, calcium hardness and total alkalinity. (Use procedures contained in this handbook). Where it is applicable, it is simpler and more convenient than the LI. Because the AI does not include the effects of temperature or dissolved solids, it is less accurate as an analytical tool than the LSI.

AI is not a quantitative measure of corrosion, but is a general indicator of the tendency for corrosion to occur and as such, should be used with proper reservation. An AI of 12 or above indicates nonaggressive (not corrosive) water. AI values below 10 indicate extremely aggressive (corrosive) conditions. Values of 10–11.9 suggest that the water is moderately aggressive.

- AI > 12, water is nonaggressive
- AI = 10 – 11.9, water is moderately aggressive
- AI < 10, water is very aggressive

In addition, copper, lead, and zinc corrosion parameters were identified. The development of the copper and lead corrosion parameters were determined using Water!Pro™. The following describes the potential results for blending softened river water with the existing water supplies at the following select communities.

**COPPER (CU), LEAD (PB) AND ZINC (ZN) INDICES**

Table A7-6 includes the USEPA drinking water limits for the three metals.

**Table A7-6. USEPA Drinking Water Maximum Contaminant Levels, Copper, Lead, Zinc.**

Metal	Drinking Water Limit (mg/L)
Copper	0.13
Lead	0.015
Zinc	5.0

Table A7-7 summarizes the corrosive/scaling indices for the water systems listed. Three water systems (Burnsville, Eagan, and Rosemont) were not included in the listing because the MDH data set did not include calcium or magnesium concentrations. However, based on the results of the listed systems, it is believed that the results would be similar to those presented.

**Table A7-7. Corrosion/Scaling Indices for Regional Water Supplies**

<b>Water System</b>	<b>pH</b>	<b>AI</b>	<b>RI</b>	<b>LSI</b>	<b>Cu (mg/L)</b>	<b>Pb (mg/L)</b>	<b>Zn (mg/L)</b>
Saint Paul Regional Water Services	9.01	14.3	7.84	1.46	0.001	0.985	0.05
Apple Valley	7.44	12.2	7.16	0.14	0.171	0.1445	1.89
Farmington	7.67	12.3	7.05	0.31	0.123	0.1493	0.78
Inver Grove Heights	7.50	12.1	7.3	0.1	0.159	0.1413	1.53
Lakeville	7.82	12.5	6.75	0.53	0.108	0.1516	0.44
South Saint Paul	7.25	12	7.28	-0.02	0.206	0.1519	3.21

Table A7-8 assumes a 50:50 blend in an attempt to identify the worse case condition where the two waters interface.

**Table A7-8: Corrosion/Scaling Indices After 50:50 Blend of Groundwater with Surface Water**

<b>Water System</b>	<b>pH</b>	<b>AI</b>	<b>RI</b>	<b>LSI</b>	<b>Cu (mg/L)</b>	<b>Pb (mg/L)</b>	<b>Zn (mg/L)</b>
Apple Valley	7.56	11.9	7.79	-0.11	0.116	0.1498	1.38
Farmington	7.82	12.1	7.64	0.09	0.081	0.1516	0.52
Inver Grove Heights	7.62	11.8	7.88	-0.13	0.106	0.1481	1.1
Lakeville	7.98	12.3	7.32	0.33	0.068	0.1526	0.29
South Saint Paul	7.36	11.7	7.94	-0.29	0.145	0.1548	2.75

**Notes:**

AI = Aggressive Index, RI = Ryznar Index, LSI = Langelier Stability Index, Cu = Copper Dissolution potential, Pb = Lead Dissolution potential, Zn = Zinc Dissolution Potential

Comparing the indices of the two tables, it appears that there will be little change in the corrosive/scaling nature of the water resulting from blending the waters. The softened waters appear to actually reduce the corrosion potential of the copper, lead, and zinc plumbing materials. However, in all instances presented in Tables A7-7 and A7-8, there is a potential to exceed the drinking water standard for lead (Pb>0.015 mg/L). If sufficient lead service lines are present in the distribution system, adding orthophosphate to the water could be used to minimize lead corrosion.

## **Appendix A8: Enhanced Recharge Study Methodology**

The methodology for the enhanced groundwater recharge study included the collection and processing of existing data sets, the development of criteria to assess the potential for enhanced groundwater recharge on a regional scale, and the evaluation of the data against the established criteria. These steps are described in detail below.

### **DATA COLLECTION**

Data relevant to infiltration and recharge criteria were collected from various sources including publicly-available Geographic Information System (GIS) datasets from local, state and national agencies. Data were placed into several categories including geology/hydrogeology, land use/natural resources, and drinking water protection. Table A8-1 shows the datasets that were collected and used in the study.

**Table A8-1. Data Sources and Datasets for Enhanced Recharge Study**

<b>Data Source</b>	<b>Dataset(s) Used</b>	<b>Reference</b>
<b>Geology/Hydrogeology</b>		
United States Department of Agriculture Natural Resources Conservation Service (NRCS) Soil Survey Geographic Database	Vertical infiltration rate data for soils, top 5 feet	(NRCS, 2014)
	Parent material for soils	(NRCS, 2014)
Minnesota Geological Survey (MGS)	Hydraulic conductivity data for unconsolidated zone	(Tipping, 2011)
	Bedrock geology	(Mossler, 2013)
Metropolitan Council Environmental Services (MCES)	Water table elevation	(Barr Engineering, 2010)
<b>Land Use and Natural Resources</b>		
MCES	Current (2010) land use	(MCES, 2011)
	Future (2030) land use	(MCES, 2014)
Minnesota Department of Natural Resources (MnDNR)	Calcareous Fens, Trout Streams, Native Plant Communities, Aquatic Management Areas, Game Refuges, Wildlife Management Areas, Federal Land/Easement, Scientific and Natural Areas, State Parks, USDA NRCS Easement, Nature Conservancy, T&E Species Areas, Regional Natural Resource Areas	(MnDNR, 2014a)
<b>Drinking Water Protection</b>		
Minnesota Department of Health (MDH)	Drinking Water Supply Management Area (DWSMA) vulnerability	(MDH, 2014a)
	Hastings Groundwater Capture Zone	(MDH, 2014b)
HDR	Calculation of Inver Grove Heights preliminary Wellhead Protection Areas (WHPAs)	
<b>Contamination Sites</b>		
MnDNR	State Water Users Database System (SWUDS)	(MnDNR, 2014b)
Minnesota Pollution Control Agency (MPCA)	What's In My Neighborhood? sites database	(MPCA, 2014a)
Minnesota Department of Agriculture (MDA)	Locations of agricultural spill investigation boundaries	(MDA, 2014)

## DATA PROCESSING

Although most datasets were incorporated into the study in their original form, processing of some datasets was required to reach project goals. Specific modifications to the datasets include the following:

- Calculation of the average vertical infiltration rate of the top 5 feet of soil;
- Calculation of hydraulic conductivity of the unconsolidated formation;
- Calculation of the depth to the water table;
- The use of the groundwater capture zones rather than DWSMAs for Hastings' wells, and;
- Calculation of preliminary wellhead protection areas for Inver Grove Heights.

**Average Vertical Infiltration Rate:** NRCS provides a vertical infiltration rate ( $k_{\text{satr}}$ ) for multiple depths within the top 5 feet of soil. An average vertical infiltration rate was assigned at each location where  $k_{\text{satr}}$  data is available. This was done by calculating a weighted average of all  $k_{\text{satr}}$  values provided for the top 5 feet of soil at each location.

**Hydraulic Conductivity:** Data prepared by Tipping (2011) were used to determine a representative value of hydraulic conductivity for the unconsolidated formation. The source data includes values for hydraulic conductivity at 20 foot intervals on a 250 meter grid. The values were assigned based on interpolations from existing well and boring logs. To determine a composite value to represent hydraulic conductivity of the overburden the harmonic mean of the values along the vertical column for each grid point was computed. This value was then applied to a 250 square meter area around each grid point. If the entire vertical profile of a grid cell was given an intermediate value of 10.05 ft/day by Tipping (2011) due to insufficient lithologic data, HDR cross-checked these areas for permeable parent material to determine aquifer recharge feasibility and factored that assessment into the Tier 2 criteria.

**Depth to Water:** The depth to water table was calculated using water table elevations obtained from the datasets prepared for the Metro Model 3 groundwater model. These point elevations were subtracted from ground surface elevation data estimated using the National Elevation Dataset (NED) 30m developed by USGS.

**Hastings Groundwater Capture Zones:** Hastings' DWSMA was removed from the dataset because it was developed based on susceptibility to contamination from surface water. MDH suggested using the Hastings groundwater capture zone instead, and provided the appropriate GIS files.

**Preliminary WHPAs for Inver Grove Heights:** At the time datasets were gathered for the study, no DWSMA (or WHPA) existed for Inver Grove Heights' wells. New preliminary WHPAs were generated by HDR in accordance with MDH published guidance, in lieu of actual WHPAs which are being produced by the city as of May 7, 2014.

Dataset processing is summarized in Table A8-2.

**Table A8-2. Processing of Data Sources for Enhanced Recharge Study**

<b>Data Source</b>	<b>Processed Dataset(s)</b>	<b>Processing Required</b>
<b>Geology/Hydrogeology</b>		
NRCS	Vertical Infiltration Rate ( $k_{\text{satr}}$ )	The average vertical infiltration rate was calculated using a weighted average of all $k_{\text{satr}}$ values in the top 5 feet of soil at a given location.
MGS	Hydraulic conductivity data for unconsolidated zone	A composite hydraulic conductivity value was calculated by taking the harmonic mean of the hydraulic conductivity of each 20-ft elevation interval created by Tipping (2011) at each grid cell.
MCES	Water table elevation	Depth to water table was calculated by subtracting the water table elevations given by Barr Engineering (2010) from the National Elevation Dataset (NED 30m).
<b>Drinking Water Protection</b>		
MDH	DWSMA vulnerability	Replaced Hastings' DWSMA with the Hastings groundwater capture zones in the DWSMA vulnerability dataset.
HDR	Calculation of Inver Grove Heights preliminary WHPAs	Added new dataset that includes preliminary WHPAs for Inver Grove Heights' wells.

**CRITERIA DEVELOPMENT**

Criteria were developed to evaluate the potential for enhanced groundwater recharge within the study area. Three levels of criteria were developed for each dataset:

- *Tier 1* criteria indicate areas that have may have good potential for enhanced groundwater recharge.
- *Tier 2* criteria indicate areas where there may be limited potential for enhanced groundwater recharge.
- *Tier 3* criteria indicate areas where there is poor potential for enhanced groundwater recharge.

The enhanced groundwater recharge criteria are presented in Table A8-3. Rationale for the criteria is presented in Table A8-4. Individual datasets used in the evaluation are depicted on Figures A8-1 through A8-10. Geology, hydrogeology, and land use criteria were partially developed with input from the Metropolitan Council Environmental Services (MCES), Minnesota Pollution Control Agency (MPCA), Minnesota Department of Natural Resources (MnDNR), Minnesota Board of Water and Soil Resources (BWSR), United States Geological Survey

(USGS), and Minnesota Geological Survey (MGS). Drinking water protection criteria were developed with input from the Minnesota Department of Health (MDH).<sup>28</sup>

The groundwater capture zones for Hastings' wells are considered vulnerable by MDH. This study also considers the preliminary wellhead protection areas calculated by HDR for Inver Grove Heights' wells to be vulnerable, which adds a degree of conservatism where actual wellhead protection areas don't yet exist. Prairie du Chien dolomite is prevalent across the study area. The Prairie du Chien can contain secondary porosity such as fractures which can result in rapid groundwater travel times (MDH, 2007). For the purposes of this study, locations where the Hastings groundwater capture zones and Inver Grove Heights preliminary wellhead protection areas are within 100 feet above Prairie du Chien dolomite are considered unsuitable for enhanced recharge.

**Table A8-3. Criteria for Evaluation of Enhanced Recharge Areas**

Criteria	What is Tier 1?	What is Tier 2?	What is Tier 3?	Report Figure #
<b>Geology/Hydrogeology</b>				
Vertical Infiltration Rate - Top 5 feet (NRCS)	>5in/hr	0.5 - 5 in/hr	<0.5 in/hr	Figure A8-1
Parent Material (NRCS)	N/A	(see Composite Hydraulic Conductivity, below)	N/A	Figure A8-2
Composite Hydraulic Conductivity (MGS)	>10 ft/day	1 - 10 ft/day, or Insufficient data but permeable parent material (glaciofluvial sediments, outwash)	<1 ft/day	Figure A8-3
Depth to Water Table (MCES)	>50 feet	≥15 feet	<15 feet	Figure A8-4
Uppermost Bedrock (MGS)	Prairie du Chien and older	St. Peter and older	Galena, Decorah, Platteville, Glenwood	Figure A8-5
<b>Land Use/Natural Resources</b>				
Current Land Use - 2010 (MCES)	Agricultural, parks, undeveloped areas	Agricultural, parks, undeveloped areas	All types other than agricultural, parks, undeveloped areas	Figure A8-6
Future Land Use – 2030 (MCES)	(2030 land use was not used in the study; a figure was generated for discussion purposes)			Figure A8-7

<sup>28</sup> Individual meetings with agency and local government representatives were held to discuss the methodology and draft evaluation criteria. Final criteria were developed with input from agency and local government representatives received at a workshop held in January 2015.



Criteria	What is Tier 1?	What is Tier 2?	What is Tier 3?	Report Figure #
Sensitive Natural Resource Areas (MnDNR)	Not within: Calcareous Fens, Trout Streams, NPC, AMA, WMA, Federal Land/Easement, SNA, State Parks, USDA NRCS Easement, Nature Conservancy, RNRA, T&E Species Areas, Game Refuge <sup>1</sup>	Not within: Calcareous Fens, Trout Streams, NPC, AMA, WMA, Federal Land/Easement, SNA, State Parks, USDA NRCS Easement, Nature Conservancy, RNRA	Within: Calcareous Fens, Trout Streams, NPC, AMA, WMA, Federal Land/Easement, SNA, State Parks, USDA NRCS Easement, Nature Conservancy, RNRA	Figure A8-8
<b>Drinking Water Protection</b>				
High or Very High Vulnerability DWSMA and <100 ft to Prairie du Chien (MDH)	Outside the limits of a vulnerable DWSMA	Outside the limits of a vulnerable DWSMA	Within the limits of a vulnerable DWSMA and < 100 ft to the Prairie du Chien	Figure A8-9
Hastings Groundwater Capture Zone and <100 ft to Prairie du Chien (MDH)	Outside the limits of a groundwater capture zone	Outside the limits of a groundwater capture zone	Within the limits of the groundwater capture zone and <100 ft to the Prairie du Chien	Figure A8-9
Preliminary WHPAs (HDR) and <100 ft to Prairie du Chien	Outside the limits of a preliminary WHPA	Outside the limits of a preliminary WHPA	Within the limits of a preliminary WHPA and < 100 ft to the Prairie du Chien	Figure A8-9
<b>Contamination Sites</b>				
SWUDS – Pollution Containment Wells (MnDNR)	(Pollution containment wells were not used in the study; a figure was generated to indicate potential locations of contamination <sup>2</sup> )			Figure A8-10
What's In My Neighborhood? Sites (MPCA)	(MPCA sites were not used in the study; a figure was generated to indicate potential locations of contamination. Included are: landfills, leak sites, multiple activity sites, petroleum brownfields, tank sites, and voluntary investigation and cleanup sites <sup>2</sup> )			Figure A8-10
Agricultural Spill Investigation Boundary (MDA)	Not within	Not within	Within	Figure A8-10

**Notes:**

Data sources are shown in parenthesis.

1 NPC = Native Plant Communities; AMA = Aquatic Management Areas; WMA = Wildlife Management Area; SNA = Scientific and Natural Area; USDA NRCS = United States Department of Agriculture Natural Resource Conservation Service; T&E = Threatened and endangered; RNRA = Regional Natural Resource Area.

2 Contaminated and potentially contaminated areas are represented by points on the figure. Further definition of contaminated areas is recommended as enhanced recharge sites are selected, on an individual basis.

**Table A8-4. Rationale for Enhanced Recharge Criteria**

Criteria	Rationale
<b>Geology/Hydrogeology</b>	
Vertical Infiltration Rate - Top 5 feet (NRCS)	<ul style="list-style-type: none"> <li>• 5 in/hr (or greater) was chosen as the Tier 1 criterion for vertical infiltration; 5 in/hr is generally considered to be a lower threshold limit for rapid infiltration basins.</li> <li>• 0.5 - 5 in/hr was chosen as the Tier 2 criterion, representing a site with limited potential for a rapid infiltration basin;</li> <li>• 0.5 in/hr, the criterion for Tier 3 areas, represents a site with poor potential for an infiltration basin. It is a slightly more conservative screening value than the 0.2 in/hr minimum recommended in the Minnesota Stormwater Manual (MPCA, 2015b) for infiltration basins.</li> </ul>
Parent Material (NRCS)	<ul style="list-style-type: none"> <li>• Parent material was used to cross-check for permeability the areas where composite hydraulic conductivity data (Tipping, 2011) is insufficient. If permeable parent material is indicated, the grid cell was deemed Tier 2 (limited potential) for recharge.</li> <li>• Coarse-grained materials such as glaciofluvial sediments and outwash are deemed feasible for transmitting water for recharge.</li> </ul>
Composite Hydraulic Conductivity (MGS)	<ul style="list-style-type: none"> <li>• 10 ft/day (or greater) was chosen as the Tier 1 criterion for hydraulic conductivity representing formation material that is conductive enough to receive recharge water from a rapid infiltration basin without excessive mounding.</li> <li>• 1 - 10 ft/day was chosen as the Tier 2 criterion for a site with limited potential for enhanced recharge.</li> <li>• &lt; 1 ft/day was chosen as the Tier 3 criterion and represents a site with poor potential for enhanced groundwater recharge. The hydraulic conductivity of the formation materials in these areas is considered too low and recharge from infiltration basins would likely cause excessive mounding.</li> </ul>
Depth to Water Table (MCES)	<ul style="list-style-type: none"> <li>• 50 feet (or greater) unsaturated thickness was chosen as the Tier 1 criterion for infiltration.</li> <li>• 15 feet was chosen as the Tier 2 criterion, representing a reasonable minimum unsaturated thickness over which water from an infiltration basin can build a sufficient vertical gradient to effectively drive infiltration. Higher water tables will require higher transmissivity to accommodate mounding.</li> </ul>
Uppermost Bedrock (MGS)	<ul style="list-style-type: none"> <li>• Subcropping Prairie du Chien and older bedrock aquifers are deemed Tier 1 (most feasible) for receiving recharge since they typically have sufficient permeability (i.e., could be effectively recharged) and are heavily pumped.</li> <li>• Subcropping St. Peter and older aquifers are deemed Tier 2 since the basal St. Peter may contain a lower confining layer that could hinder recharge to lower aquifers.</li> <li>• Subcropping Galena, Decorah, Platteville, and Glenwood formations are typically considered to be either 1) a confining unit, or 2) not typically used for water supply, and are deemed Tier 3 for receiving recharge.</li> </ul>
<b>Land Use/Natural Resources</b>	
Current Land Use (MCES)	<ul style="list-style-type: none"> <li>• Agricultural, parks, and undeveloped areas may have land available and are considered Tier 1 and Tier 2 for locating large infiltration basins.</li> <li>• All other types of land use are considered Tier 3 since the land is already developed.</li> <li>• Minimum 20 acre tract size for infiltration basin.</li> </ul>

Criteria	Rationale
Natural Resource Areas (MnDNR)	<ul style="list-style-type: none"> <li>• Calcareous Fens, Trout Streams, NPC, AMA, Game Refuge, WMA, Federal Land/Easement, SNA, State Parks, USDA NRCS Easement, Nature Conservancy, and RNRA are Tier 3 for locating infiltration basins since they are sensitive and/or protected natural resources.</li> <li>• T&amp;E Species Areas and Game Refuges are considered Tier 2 (generally feasible) for locating infiltration basins at this time based on low potential for impact to those areas.</li> </ul>

### Drinking Water Protection

High or Very High Vulnerability DWSMA and <100 ft to Prairie du Chien (MDH)	Considered to be Tier 3 (unfeasible). MDH guidance (MDH, 2007) specifies stormwater infiltration should not occur where less than 100 feet of unconsolidated sediments separate fractured bedrock (e.g., Prairie du Chien dolomite) from the ground surface within a vulnerable DWSMA. This guidance is in place to protect vulnerable public supply wells from potential pathogens.
Hastings Groundwater Capture Zone and <100 ft to Prairie du Chien (MDH)	Rationale is similar to DWSMAs, above. The Hastings groundwater capture zones are considered vulnerable by MDH.
Preliminary WHPAs (HDR) and <100 ft to Prairie du Chien	Rationale is similar to DWSMAs, above. The Preliminary wellhead protection areas for Inver Grove Heights are considered vulnerable for this study.

### Contamination Sites

SWUDS – Pollution Containment Wells (MnDNR)	Note: Pollution containment wells were plotted as points for the study. Further definition of contaminated areas is recommended as enhanced recharge sites are selected, on an individual basis.
What's In My Neighborhood? Sites (MPCA)	Note: MPCA database sites were plotted as points for the study. Further definition of contaminated areas is recommended as enhanced recharge sites are selected, on an individual basis.
Agricultural Spill Investigation Boundary (MDA)	MDA investigation boundaries indicate areas that may be contaminated and are deemed Tier 3 for recharge.

### DATASET EVALUATION

The datasets were imported into GIS and new subsets of data were identified at the intersection of specific criteria. Polygons were created to identify the areas where specific features or portions of features from the various datasets overlapped. These areas represent the results of the enhanced recharge study, and were classified as follows:

- *Tier 1* subsets from each of the various datasets were merged to show the areas where all of the Tier 1 criteria were met. These are areas that may have good potential for enhanced groundwater.
- *Tier 2* subsets from each of the various datasets were merged to show the areas where all of the Tier 2 criteria were met. These are areas where there may be limited potential for enhanced groundwater recharge. However, it is possible that local conditions are more favorable than what is indicated in the regional datasets for the Tier 2 areas.

- *Tier 3* areas are those not classified as Tier 1 or Tier 2, indicating that there is poor potential for enhanced groundwater recharge. For an area to be classified as Tier 3, any one of the criteria for a Tier 3 recharge location needed to be met.

#### **ENHANCED GROUNDWATER RECHARGE FACILITY COSTS**

Conceptual level costs were developed for a range of recharge basin sizes and design concepts, including a traditional above-ground recharge basin and a system with sub-surface distribution chambers. Capital cost estimates for recharge basins were based on construction costs obtained from recent bids on similar types of construction in Minnesota, quoted unit costs from RS Means, and unit costs from HDR historical costs on similar projects.

Assumptions used to develop the costs are listed below.

#### **Capital Cost Items**

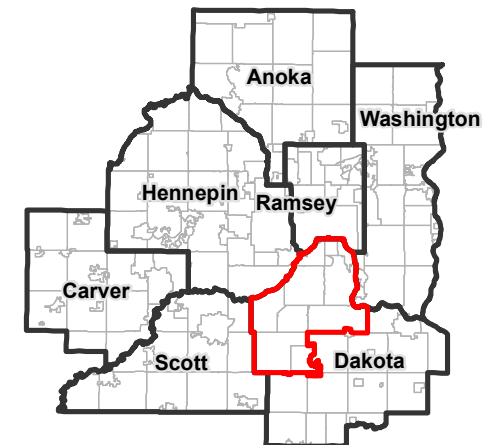
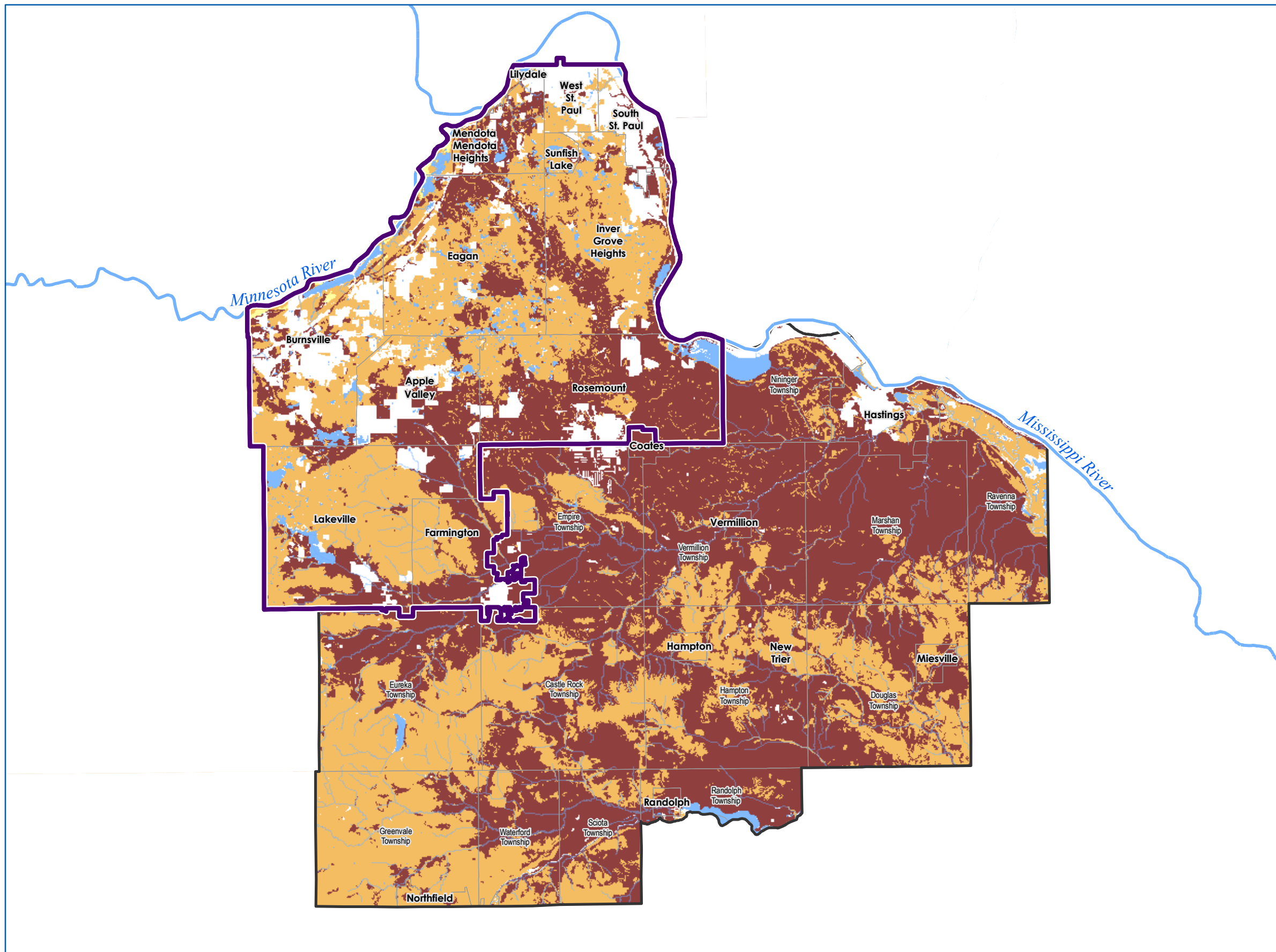
- **Mobilization/Demobilization** – approximately 2% of construction subtotal cost.
- **Clearing and Grubbing** – Assumed ¼ of the site needs to be cleared and grubbed.
- **Topsoil stripping & haul off-site** – 12” deep across the entire site.
- **Coarse graded sand** – 12” thick for basin bottoms, 1.2 tons per cubic yard.
- **Embankment for Berms – hauled in** – 3 feet high berms, 12 feet wide at top, 3:1 side slopes for entire embankment.
- **Crushed Surfacing Top Course** – 6” thick for 12’ wide access road, entire length of access roads, 1.4 tons per cubic yard.
- **Facility Piping** – Buried 8” ductile iron pipe to deliver water around the site and to each infiltration subbasin or subsurface gallery.
- **Distribution Header** – 18” perforated corrugated steel pipe set at grade in each basin for distribution of flow.
- **Control Valve** – 8 inch valve at each basin controlled by the local control panel operating by PLC on a set operational schedule.
- **Security Fence** – Fencing to surround the site
- **Landscaping** – approximately 2% of construction subtotal cost
- **Instrumentation and Electrical** – All instrumentation and control facilities on the site.
- **Power** – Power drop to extend power to the site.
- **Filtration System** – Contech StormFilter® media filtration system
- **Pumps** – 2000 GPM pumps, 60 HP, 8” discharge
- **Precast Concrete Vault for Control Structure** – 8’ x 14’ x 7’ concrete vault for control structure
- **Control Valve** – 8” valve at each basin controlled by the local control panel operation by PLC on a set operational schedule.
- **Flow Meter** – Circuit Sensor Flow Meter for 8” pipe
- **Water Quality Monitoring** – Monitoring Well installation and initial startup (background) monitoring including lab analysis.
- **Silt Fence** - Assumed same quantity as Security Fencing
- **Seeding** – Area of the site minus aggregate access road or sand surfaces in recharge basins
- **Seed Mixture** – 70 pounds per acre of Seeding
- **Mulch** – 2 tons per acre of Seeding
- **Fertilizer** – 200 pounds per acre of Seeding

## **Indirect Cost Items**

- **Construction Contingency** – 30 percent of construction subtotal
- **Engineering, Permitting, and Administration** – Engineering, permitting costs and fees, and costs incurred by owner for administration and management of the project were estimated to be 20 percent of construction subtotal.

## **Excluded Costs**

- Costs do not include property acquisition, construction management, surveying costs, operations and maintenance, or rehabilitation costs.



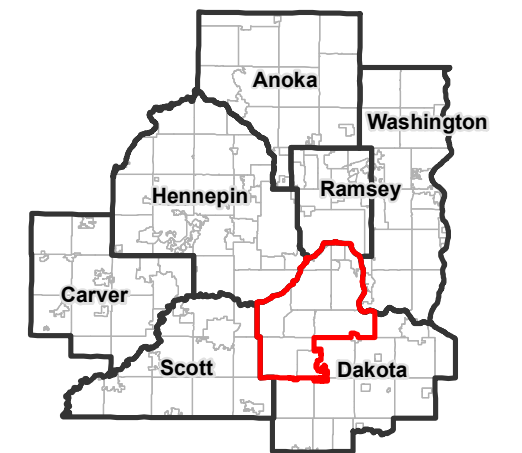
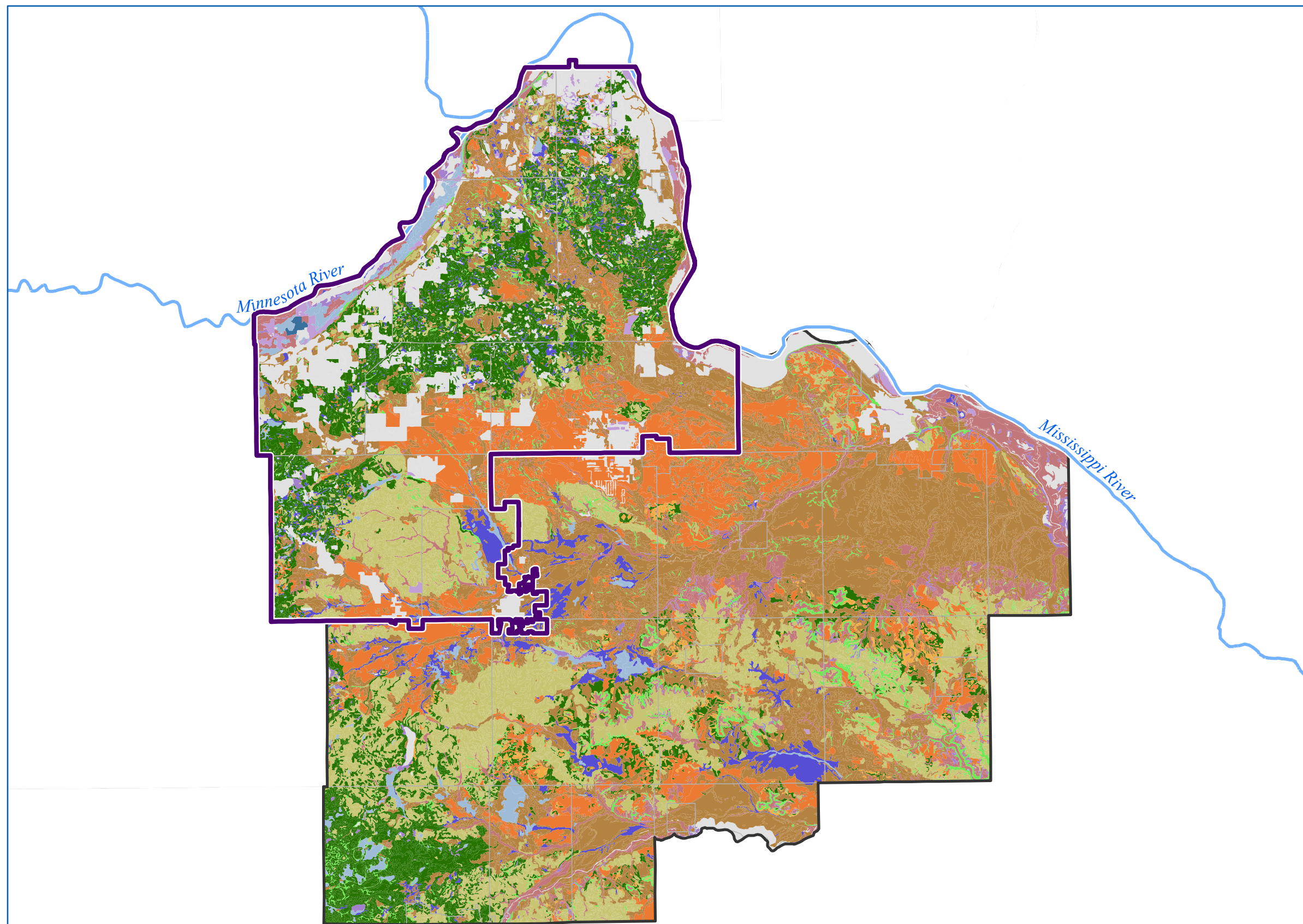
Legend

- Average Vertical Infiltration Rate (in/hr)**
- > 5 in/hr (Tier 1)
- 0.5-5 in/hr (Tier 2)
- < 0.5 in/hr (Tier 3)
- Study Area
- County Boundary
- City/Township Boundary
- Perennial Stream
- Waterbody

Note: Average vertical infiltration rates calculated from NRCS ksar values (NRCS, 2014)

Sources: USDA NRCS, NHD, DNR

0 20,000 Feet

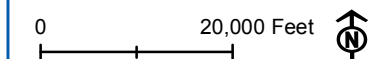


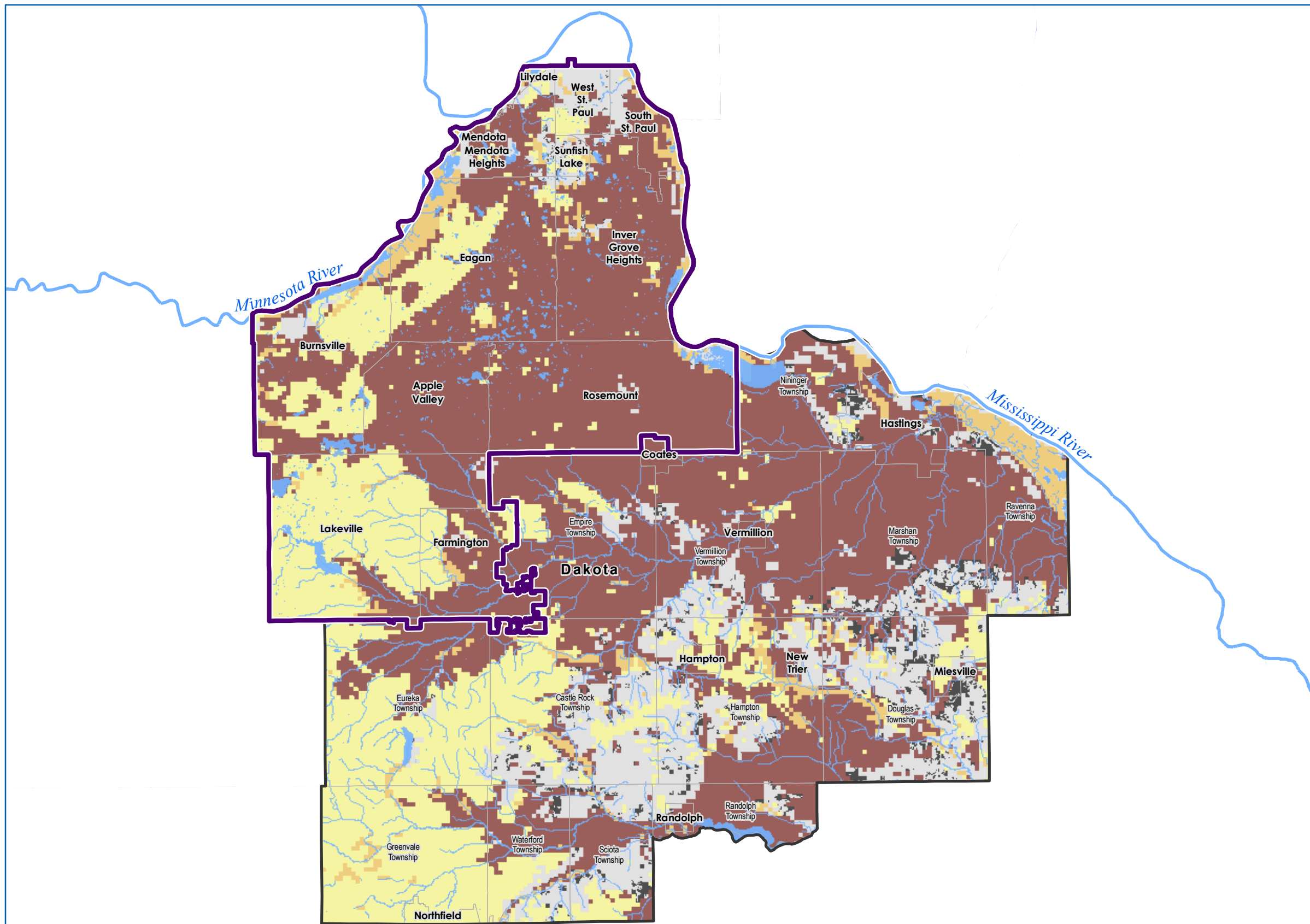
Legend

- Tier 2**
- Glaciofluvial Sediments
- Outwash
- Variable Sandy Material
- Tier 3**
- Alluvium
- Colluvium
- Glaciolacustrine Sediments
- Lacustrine Sediments
- Limestone and Sandstone Bedrock
- Loess
- Organic Material
- Till
- Variable Loamy Material
- Variable Soil Material
- Unknown Parent Material
- Study Area
- County Boundary
- City/Township Boundary

Note: Tier 1 recharge criteria does not incorporate soil parent material.

Sources: USDA NRCS, NHD, DNR





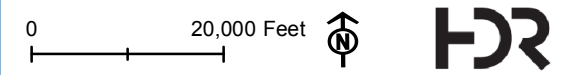
**Legend**

**Hydraulic Conductivity (ft/day)**

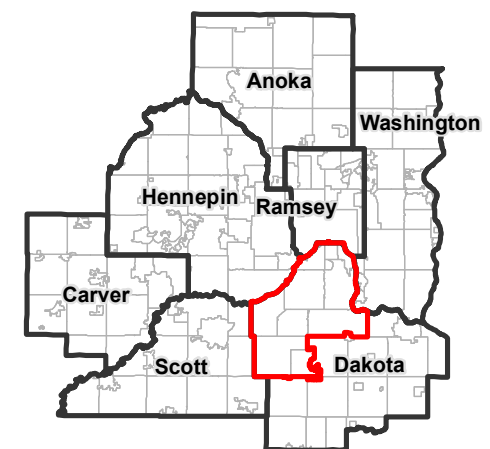
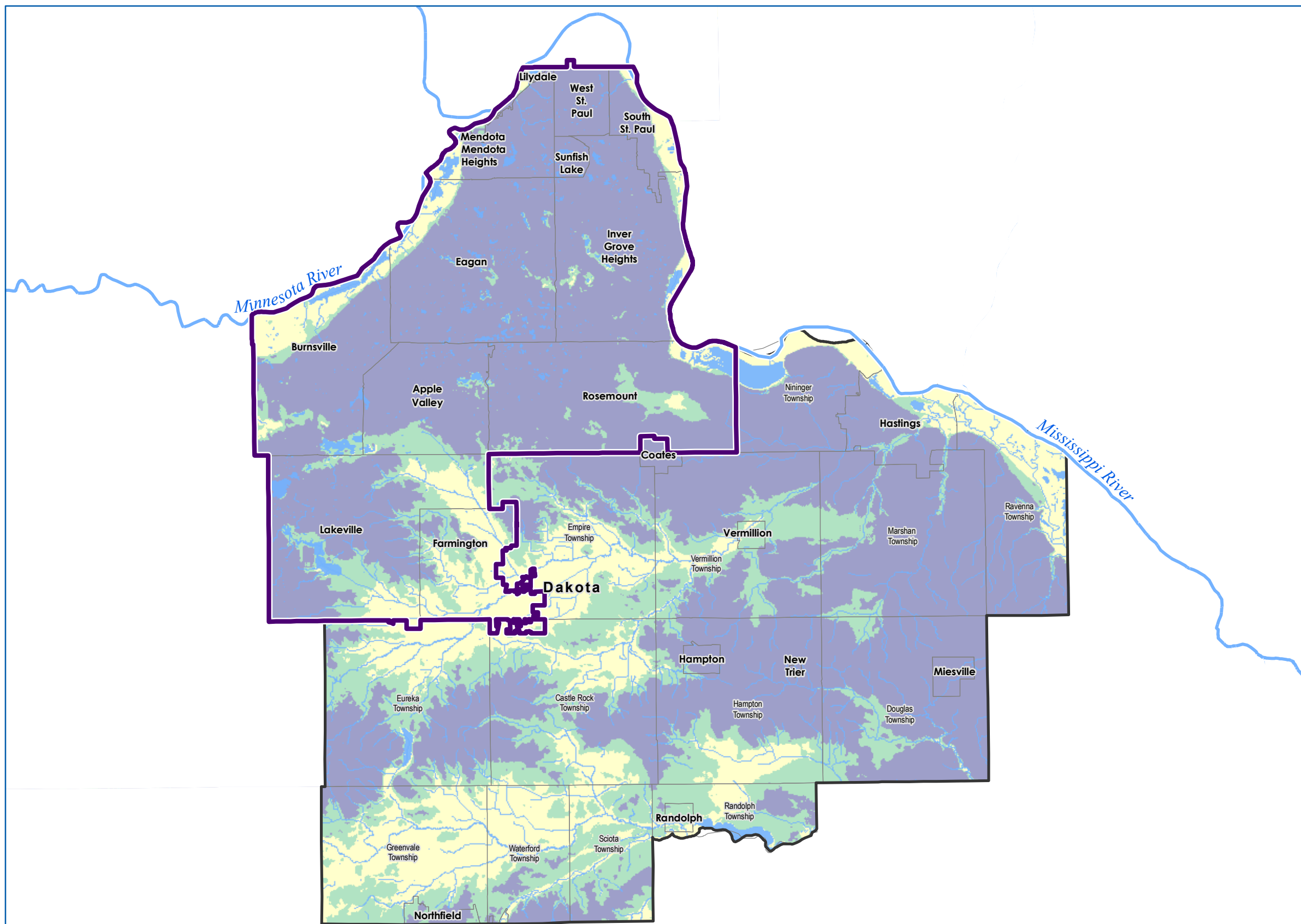
- > 10 (Tier 1)
- 1-10 (Tier 2)
- < 1 (Tier 3)
- Insufficient Data (Permeable Parent Material)
- Insufficient Data
- Study Area
- County Boundary
- City/Township Boundary
- Waterbody
- Perennial Stream

Note: Composite hydraulic conductivity calculated from Tipping (2011).

Sources: MGS Tipping, NHD, DNR







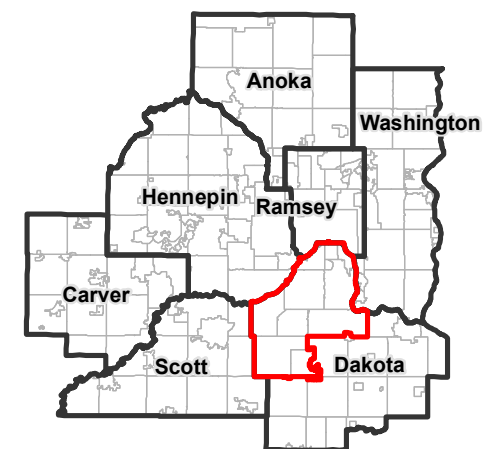
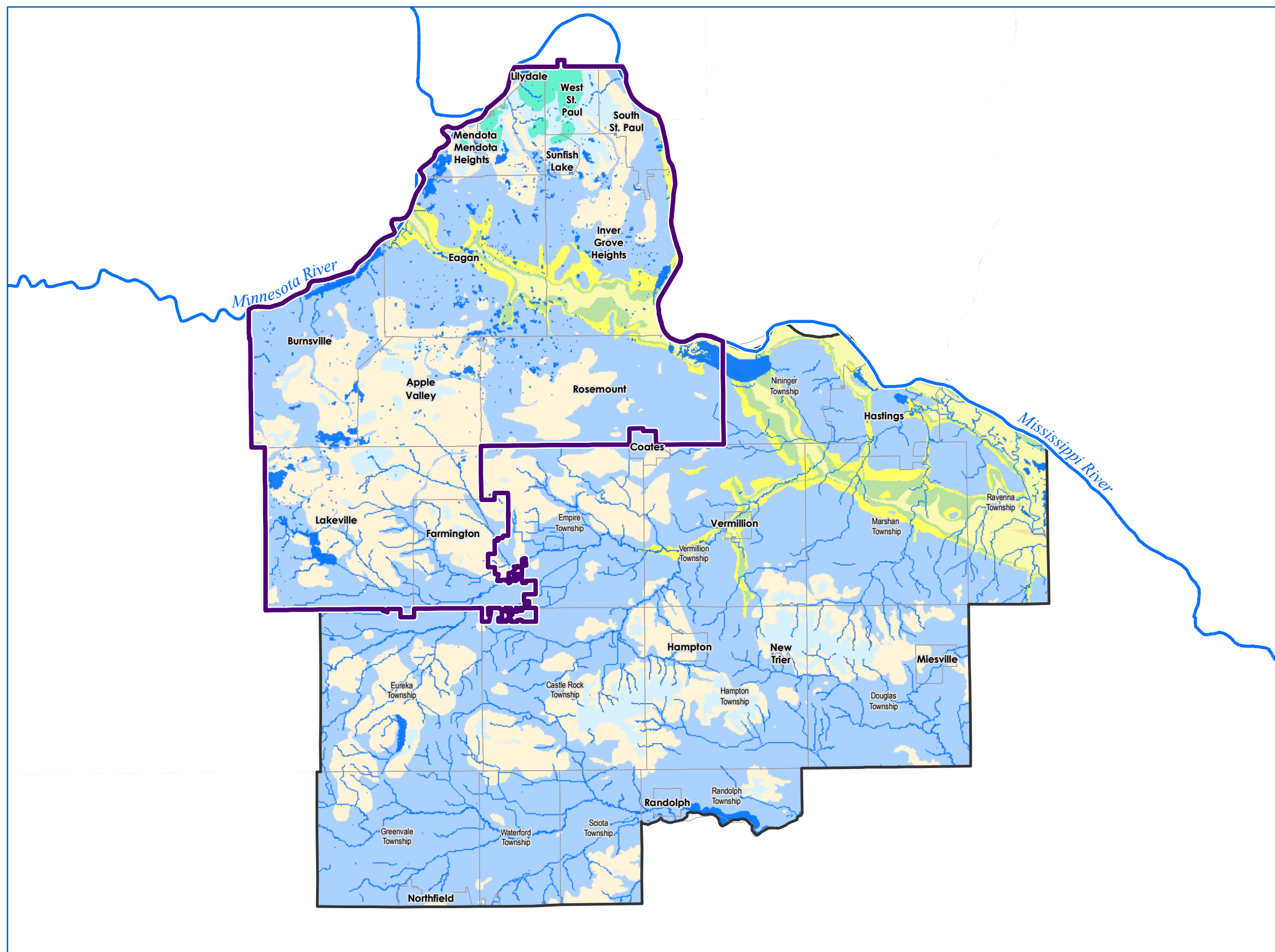
Legend

- Depth to Water Table (ft)**
- > 50 (Tier 1)
  - 15-50 (Tier 2)
  - < 15 (Tier 3)
  - Study Area
  - County Boundary
  - City/Township Boundary
  - Waterbody
  - Perennial Stream

Note: Depth to regional water table calculated from NED surface elevations and regional water table elevations (Barr, 2010).

Sources: Barr, NHD, DNR

0 20,000 Feet



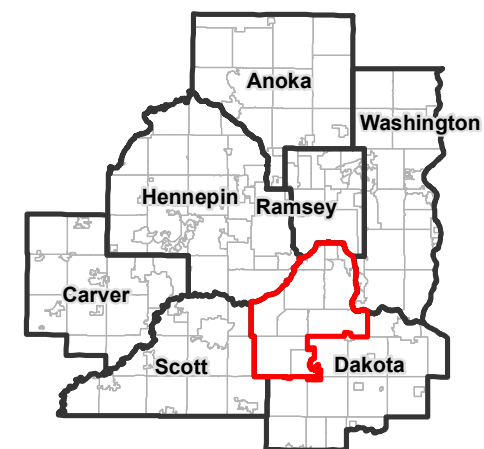
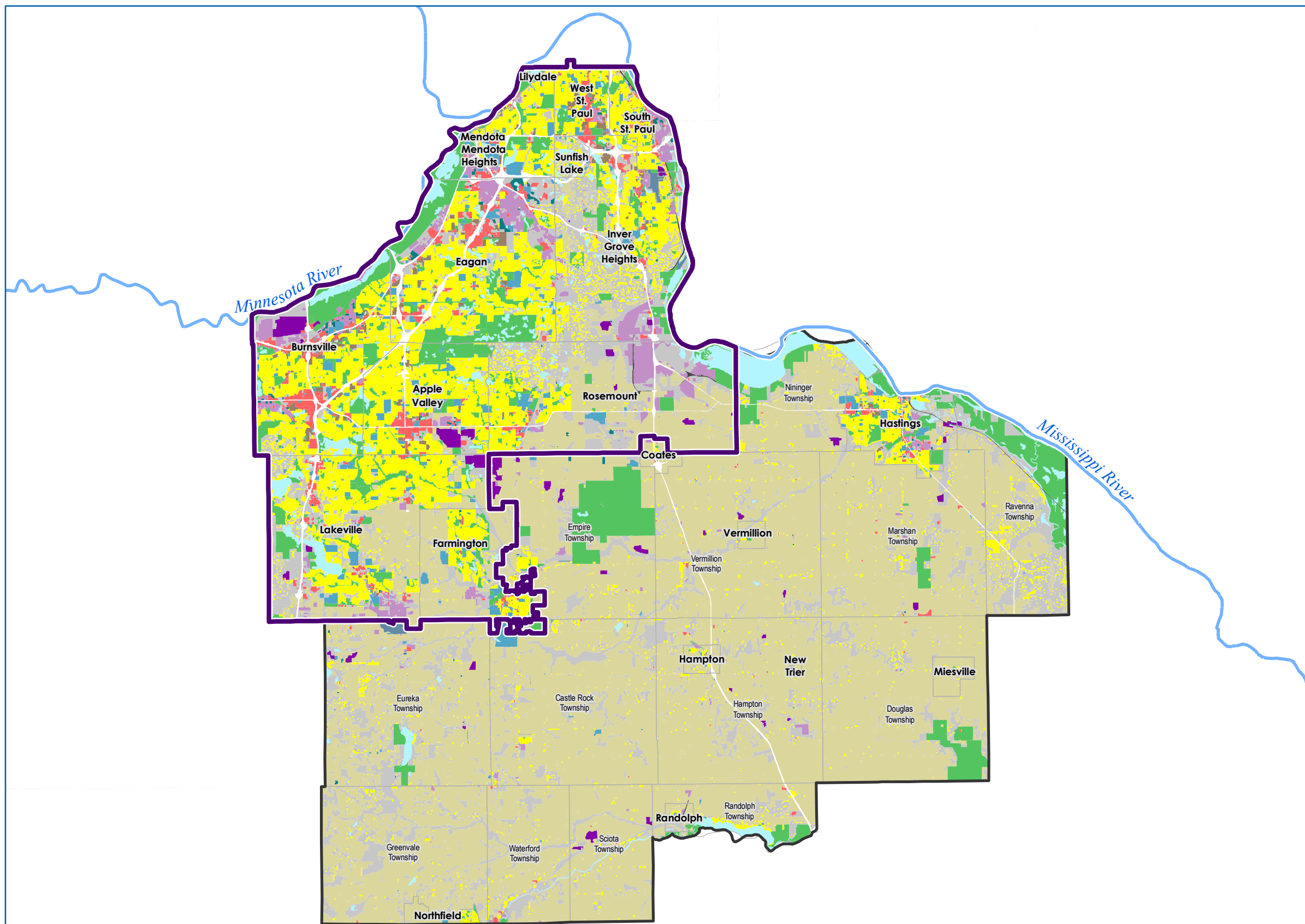
Legend

- Paleozoic Rocks**
- Tier 3**
- Young
- Galena and Decorah Formations
  - Platteville and Glenwood Fms
- Tier 2**
- St. Peter Sandstone
- Tier 1**
- Prairie du Chien Group
  - Jordan Sandstone
  - St. Lawrence Formation
  - Tunnel City Group
  - Wonewoc Sandstone
  - Eau Claire Formation
  - Mt. Simon Sandstone
  - Precambrian Sedimentary Rocks
- Old
- Study Area
  - County Boundary
  - City/Township Boundary
  - Waterbody
  - Perennial Stream

Note: Bedrock geology reproduced from Mossler (2013).

Sources: MGS, NHD, DNR

0 20,000 Feet



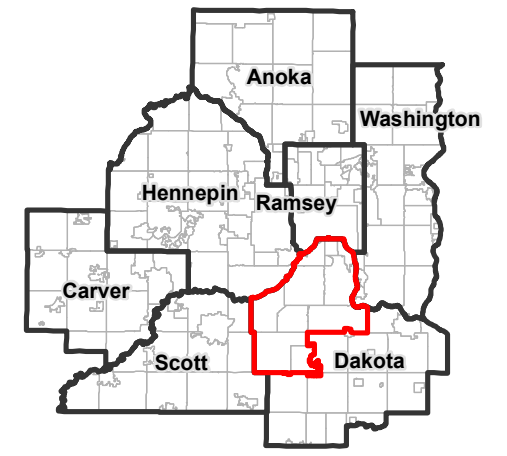
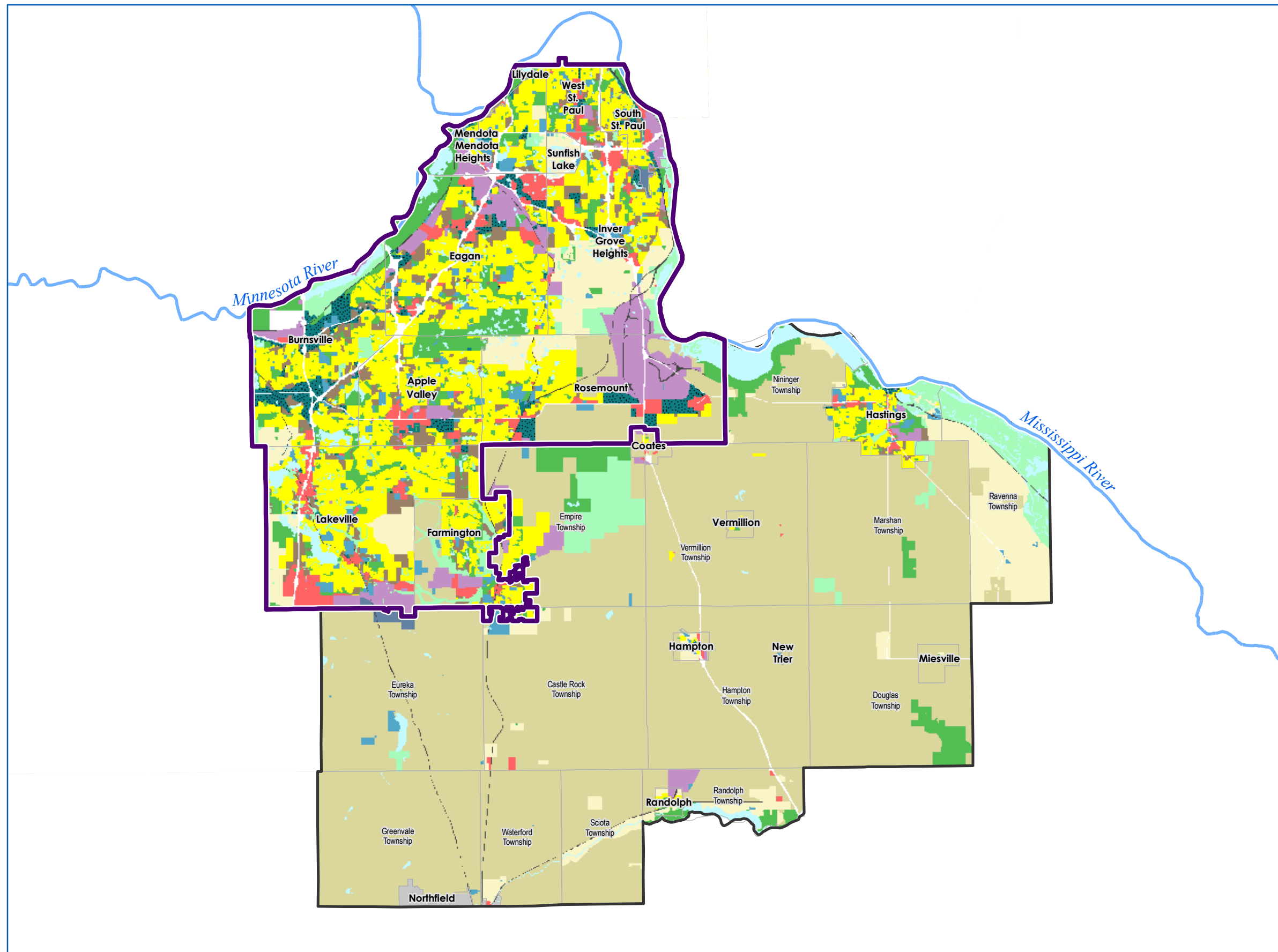
Legend

- Tier 1 & 2**
  - Agricultural
  - Park and Recreation
  - Undeveloped
- Tier 3**
  - Single Family Residential
  - Multifamily Residential
  - Commercial
  - Extractive
  - Industrial
  - Institutional
  - Mixed Use
  - Rights-of-Way (i.e., Roads)
  - Railway (inc. LRT)
  - Airport
  - Open Water
  - Study Area
  - County Boundary
  - City/Township Boundary

Note: Land use mapping provided by Metropolitan Council Environmental Services (2011).

Sources: Met Council, NHD, DNR





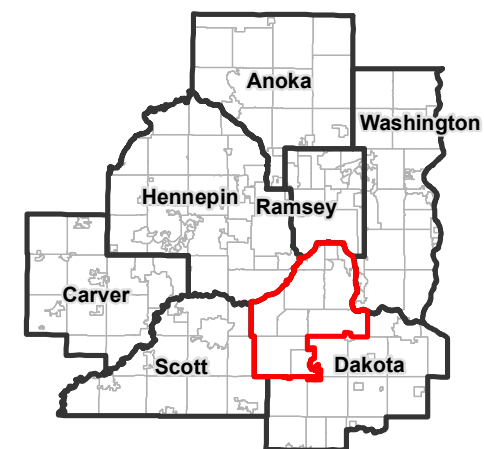
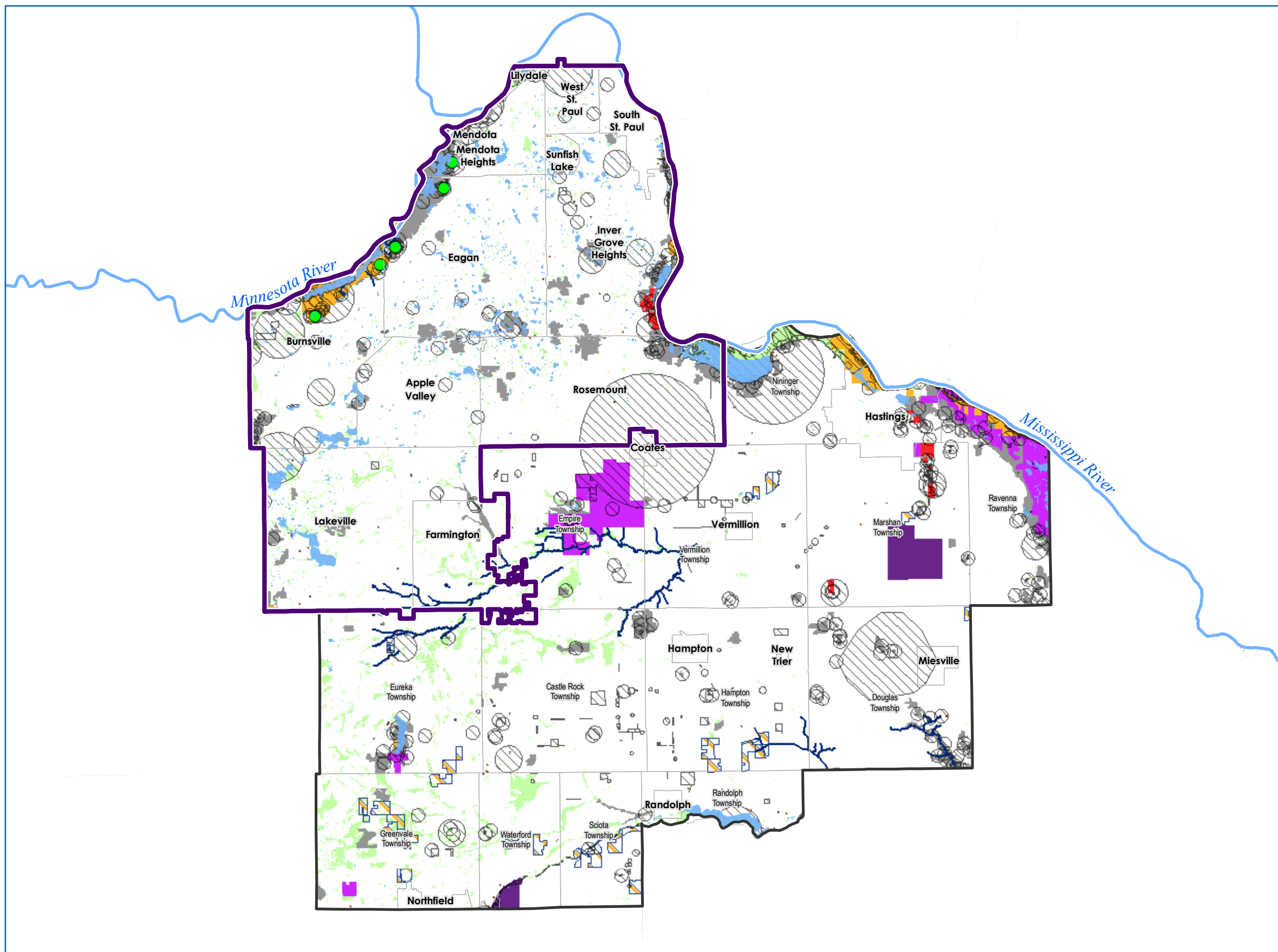
**Legend**

- Agricultural
- Rural or Large-Lot Residential
- Single Family Residential
- Multifamily Residential
- Commercial
- Industrial
- Institutional
- Mixed Use
- Multi-Optional Development
- Park and Recreation
- Open Space or Restrictive Use
- Rights-of-Way (i.e., Roads)
- Railway (inc. LRT)
- Airport
- Vacant or Unknown
- Open Water
- Study Area
- County Boundary
- City/Township Boundary

Note: Land use mapping provided by Metropolitan Council Environmental Services (2014).

Sources: Met Council, NHD, DNR

0 20,000 Feet



Legend

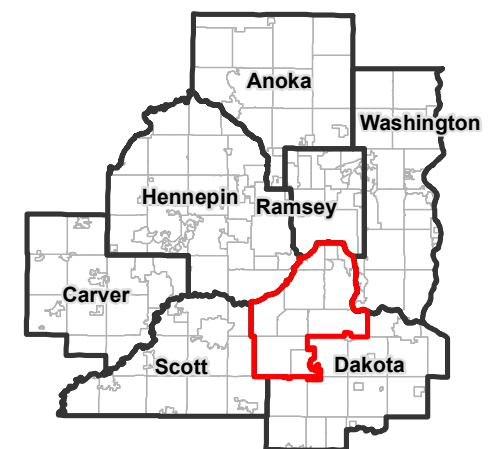
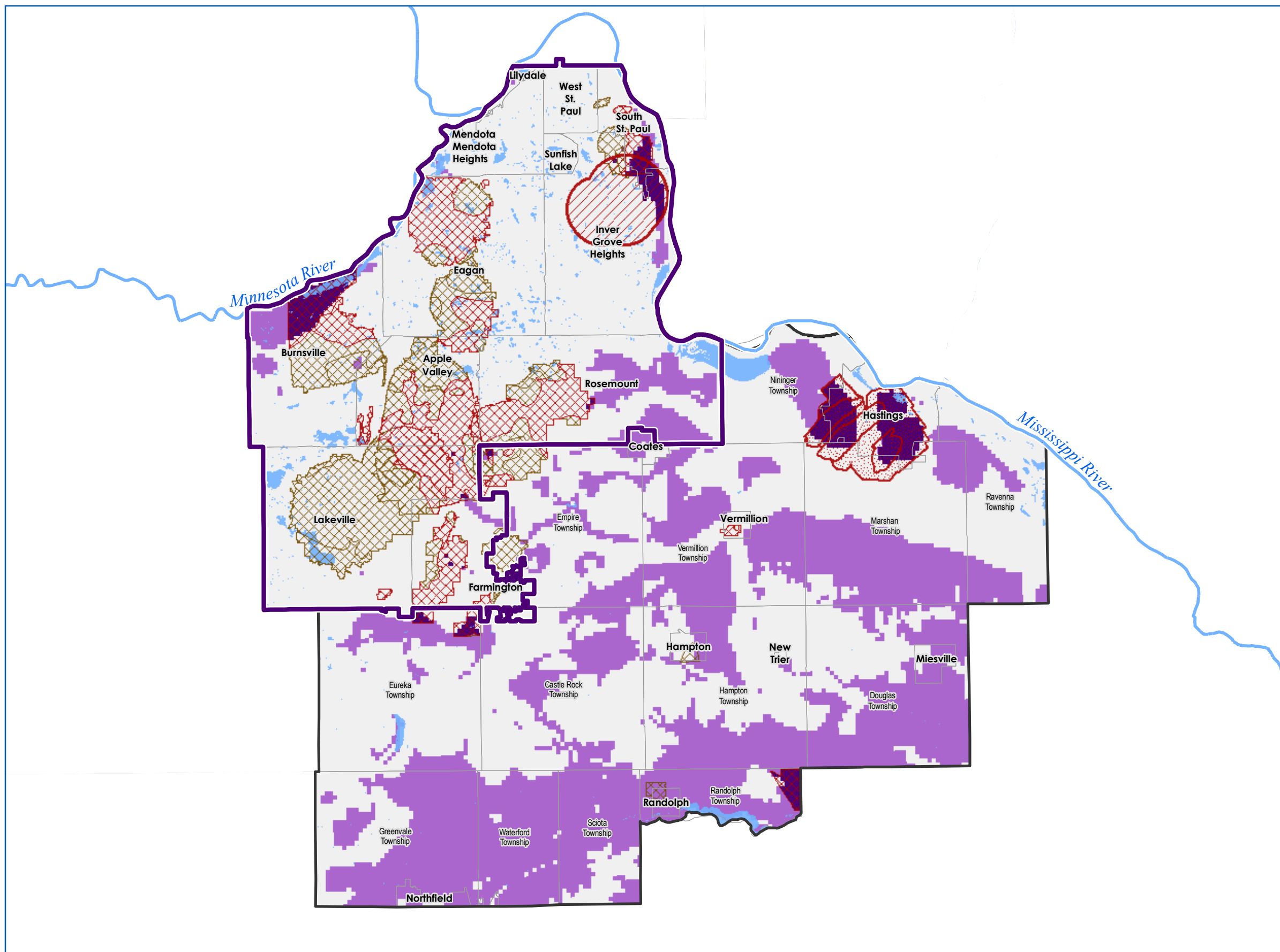
- Tier 2**
- Potential T&E Species Area
- Game Refuge
- Tier 3**
- Calcareous Fen
- Designated Trout Stream
- Native Plant Community
- Aquatic Management Area
- Wildlife Management Area
- Federal Land / Easement
- Scientific & Natural Area
- State Park
- USDA NRCS Easement
- Regional Natural Resource Area
- The Nature Conservancy
- County Boundary
- City/Township Boundary
- Waterbody
- NWI Wetland
- Study Area

Tier 1: Areas not designated as Tier 2 or Tier 3

Note: Sensitive natural resources mapping provided by MnDNR (2014a).

Sources: MPCA, NHD, DNR





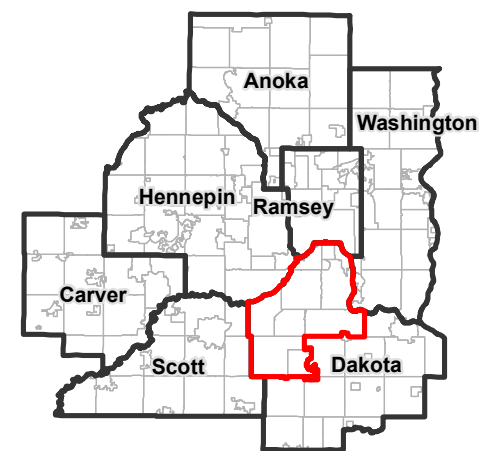
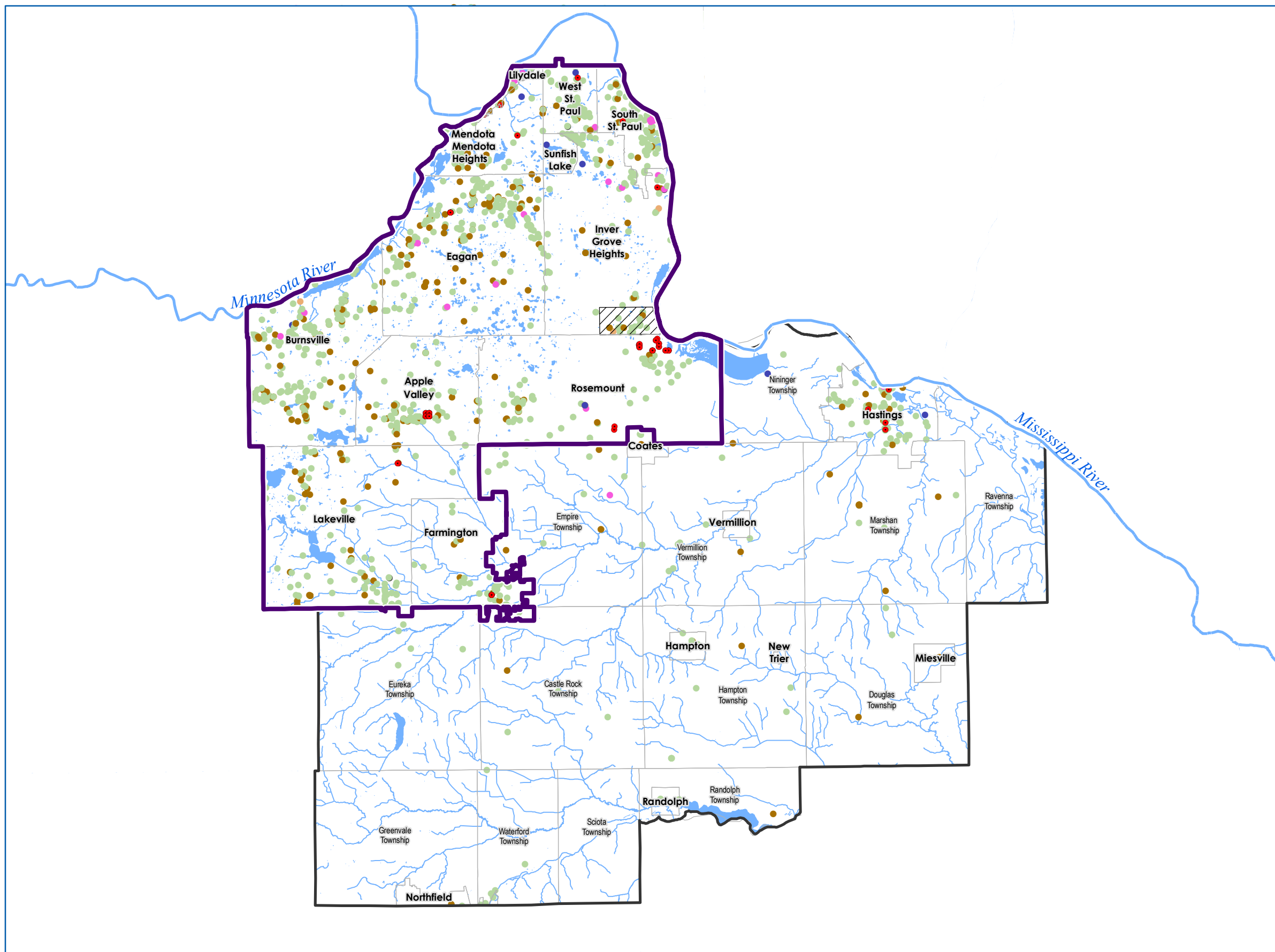
**Legend**

- DWSMA
- Vulnerable DWSMA
- Preliminary WHPA (HDR)
- Hastings Groundwater Capture Zone
- Depth to Prairie du Chien < 100'
- Prairie du Chien not Subcropping (or Depth > 100')
- Tier 3 Groundwater Capture Zone and Depth to Prairie du Chien < 100'.
- Study Area
- County Boundary
- City/Township Boundary

All non-Tier 3 areas meet Tier 1 and Tier 2 criteria.

Sources: MDH, NHD, DNR

0 20,000 Feet

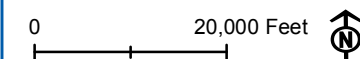


Legend

- Pollution Containment Well (DNR)
- ▨ Special Well and Boring Construction Area
- MPCA Database Sites**
- Landfill, Open
- Leak Site
- Multiple Activities
- Petroleum Brownfield
- Tank Site
- Voluntary Investigation & Cleanup (VIC)
- ▭ Study Area
- ▭ County Boundary
- ▭ City/Township Boundary
- Waterbody
- Perennial Stream

Note: Contaminated property boundaries and plume dimensions not shown.

Sources: MPCA, MDA, NHD, DNR



## Appendix A9: Stormwater Capture and Reuse Evaluation

### METHODOLOGY AND ANALYSIS

To assess the potential for stormwater capture and reuse within the study area, a simple comparison of the total non-winter runoff volume and the total groundwater demands was computed. Stormwater runoff volume for the study area was calculated using the Rational Method, applying runoff coefficients based on land use classifications for the study area. Runoff volumes were calculated for subwatersheds within a study area, and then summed to estimate runoff for the entire study area.

Non-winter months were defined as the period March 15 through November 31. To determine runoff potential, 2010 Land Use Information provided by Met Council data were correlated to similar Minnesota Land Cover Classification System (MLCCS) classes to determine appropriate runoff coefficients. The Rational Method was then used to estimate the expected average annual non-winter runoff for the entire study area, where annual Runoff ( $R_{\text{annual}}$ ) is equal to:

$$R_{\text{annual}} = \sum [(P * P_j * R_v) / 12](A), \text{ where}$$

$R_{\text{annual}}$  = Total annual non-winter runoff from the study area drainage area, acre-ft.  
 $P$  = Depth of rainfall in inches per year (29.3 inches)<sup>1</sup>  
 $P_j$  = Fraction of rainfall events that produce runoff (set to 0.9)  
 $R_v$  = Runoff coefficient (ranges from 0.0 to 1.0 based on land cover)  
 $A$  = Cover type area (acres)

For example, if watershed “A” has an area ( $A$ ) = **1,000 acres**.

Using the Met Council 2010 Generalized Land Use data, Watershed “A” has 400 acres of Single Family Detached residential land use, 300 acres of Multifamily residential land use, 100 acres of Industrial and Utility land use, and 200 acres of Agricultural land use. The Met Council land use types were correlated with the Minnesota Land Cover Classification System to determine runoff coefficients for those land uses. Thus, runoff coefficients ( $R_v$ ) were determined for those four land uses are:

$$\begin{aligned} R_v (\text{Single-Family Detached Residential}) &= 0.392 \\ R_v (\text{Multifamily Residential}) &= 0.617 \\ R_v (\text{Industrial and Utility}) &= 0.91 \\ R_v (\text{Agricultural}) &= 0.30 \end{aligned}$$

Thus, the weighted runoff coefficient ( $R_v$ ) for the entire Watershed “A” is:

$$R_v (\text{Watershed A}) = [(400 \text{ acres} * 0.392) + (300 \text{ acres} * 0.617) + (100 \text{ acres} * 0.91) + (200 \text{ acres} * 0.30)] / 1000 \text{ acres} = \mathbf{0.493}$$

---

<sup>1</sup> Depth of Rainfall is the 30-year average (1981-2010) of non-winter (March 15 to November 30) precipitation from the six National Centers for Environmental Information (NCEI) rain gage stations within the study area (NCEI, 2015).



Annual non-winter precipitation (P) was calculated using a 30-year average of non-winter precipitation, from March 15<sup>th</sup> – November 30<sup>th</sup> between 1981 and 2010. This annual precipitation (P) = **29.3 inches**

Thus, using the modified Rational Method equation,

$$\text{Annual Runoff (R}_{\text{annual}}) = [(29.3 \text{ inches} * 0.9 * 0.493) / (12 \text{ inch/foot})] * 1,000 \text{ acres} = \underline{\mathbf{1,083.37 \text{ ac-ft}}}$$

Water use data from the MnDNR SWUDS database was used to quantify total annual groundwater use for the study area. A comparison of total annual non-winter runoff to average groundwater demand provides a gross assessment of the stormwater supply to groundwater demand for the study area. The difference between the two volumes is a theoretical estimate of the maximum potential groundwater offset provided by stormwater runoff. This gross estimate does not take into account water uses appropriate for captured stormwater, or several conditionally-dependent factors that would ultimately define the potential for stormwater to meet specific demands. However, it does provide a relative assessment of a study area's potential to meet some portion of demands for non-potable use with stormwater. A comparison of non-potable uses in the MnDNR SWUDS and municipal use data to non-winter runoff volume further defines the potential for beneficial use of stormwater in the study area.

The refined analysis compared high-volume uses within the study area to specific, local sub-watershed runoff volumes. These uses included both permitted groundwater users obtained from the MnDNR SWUDS database, and municipal users identified from data obtained from communities in the study area. Uses were screened to identify uses associated with non-potable use, such as urban irrigation, major crop irrigation, and industrial processing. Average annual demands were tabulated for each user.

For each identified location, a drainage area was delineated using the LiDAR-based digital elevation model within ArcHydro (ESRI) with standard GIS-based watershed delineation methods. A drainage area spill point was assigned to each of the 195 sites. These spill points were selected to represent the furthest downslope location on a stormwater conveyance (either a ditch or storm sewer) within each of the drainage areas. These drainage areas (shown on Figure 26), in addition to land use/land cover and average regional precipitation data were used to determine the average non-winter runoff to each site. Where the drainage area of one water use site was located within the drainage area of another water use site, the overall run-on volume was calculated for the furthest downstream site to eliminate double-counting of volumes.

Results were tabulated showing stormwater runoff to specific sites and average annual water use at specific sites within the study area. A supply to demand ratio was calculated to assess the general potential for stormwater to satisfy some portion of groundwater demand at each site.

The results of the enhanced recharge analysis were incorporated into the stormwater analysis. Areas identified as meeting Tier 1 or Tier 2 criteria were included as sites for potential reuse of stormwater. Drainage areas for each potential enhanced recharge area were delineated (see Figure 26), and total annual non-winter runoff to these sites was computed as described earlier.

More detailed analysis of stormwater reuse potential should consider site-specific factors including local precipitation trends, evapotranspiration, soil types and antecedent soil moisture conditions, and seasonal variability related to timing of use. Use-specific considerations, including water quality requirements, and application rate and period should be factored into more detailed analyses of potential applications. Other factors related to infrastructure requirements, including the sizing of the storage or containment facilities, site constraints, application areas, and overflow location and capacity, among others, should be assessed during future study phases, or in support of implementation.

#### **STORMWATER REUSE APPLICATIONS**

Stormwater may be captured and reused for both non-potable and potable uses. Non-potable uses for stormwater are generally easier to implement and permit. The most widespread non-potable use for stormwater is irrigation, which accounts for approximately 34 percent of all water use in the United States (McPherson, 2015). Other non-potable uses of stormwater include toilet flushing and clothes washing. Common applications for these uses may include schools or other institutional facilities. Reuse of stormwater for potable use is possible but requires a high degree of treatment to meet drinking water standards.

In the industrial environment, generally, 80 to 90 percent of water is used for cooling and process water. Industrial uses of stormwater can be complex and expensive to implement due to quality requirements. The intended use for the industrial application dictates the treatment process and monitoring requirements. Stormwater reused in industrial applications may need to meet certain pH, conductivity, temperature, TSS, and TDS standards.

#### **STORMWATER CAPTURE AND REUSE SYSTEM FEATURES**

Stormwater capture and reuse systems commonly include collection, filtration, disinfection, storage, pumping, and bypass components. The size and extent of each component will depend on the intended application, site characteristics, and local regulatory and permitting requirements.

Collection systems may vary depending on how stormwater is collected. In this study, collection of stormwater from conveyance systems was considered. These included pipe networks consisting of a series of catch basins and stormwater pipes, and ditch systems. It is also possible to collect runoff from rooftops, although these types of systems were not considered for the regional-scale systems considered in this report.

After collecting in the storm sewer network, collected stormwater usually passes through an in-line screen to remove leaves, twigs, and other debris before entering a storage component. In addition, additional solids removal may be accomplished through the addition of a pre-treatment forebay where solids are allowed to settle out before entering storage.

Storage typically occurs in one of three forms including pond storage, below-ground storage, and above-ground storage, described in more detail below. Advantages and disadvantages of each type of system are summarized in Table A9-1.

- **Pond storage system.** Ponds should be designed in accordance with the Minnesota Stormwater Manual (MPCA, 2015d). A typical pond stores water three to five feet deep and normally maintains a permanent storage volume to provide water quality treatment. For stormwater reuse, a pond should be constructed so that the bottom is relatively impermeable. Soil testing is required to determine whether the existing material is suitable or whether the pond needs to be supplemented with a clay pond liner. Ponds should be located in areas with limited public access or provided with a fence to reduce the risk of drowning.
- **Below-ground storage tanks.** For smaller underground storage tanks, materials such as polypropylene, fiberglass, and concrete are commonly used. Large underground storage tanks are typically constructed of concrete. Other considerations for the design of underground storage tanks include designing around utilities and infrastructure, water tables, expansive soils, and high-traffic areas at the ground surface.
- **Above-ground storage tanks.** For above-ground tanks, foundations must be designed to carry the weight of the full tank. Foundations must be located away from natural drainage pathways. Above-ground storage tanks are most effective when collecting water from roofs, as water would need to be pumped into the tank when it is collected from the ground.

**Table A9-1. Types of Stormwater Storage Systems**

Type	Advantages	Disadvantages
Pond	<ul style="list-style-type: none"> <li>Low Capital Costs</li> <li>Low Maintenance Costs</li> <li>Ponds provide dual purpose</li> </ul>	<ul style="list-style-type: none"> <li>Public safety concerns if unfenced</li> <li>Mosquito breeding habitat</li> <li>Storage losses due to evaporation</li> <li>Storage could limit flood protection capacity</li> </ul>
Below-Ground Storage	<ul style="list-style-type: none"> <li>Concealed from view</li> <li>Space at ground surface remains available for other uses</li> </ul>	<ul style="list-style-type: none"> <li>Higher capital costs</li> <li>Higher maintenance costs</li> <li>Stronger structure needed if located underneath parking area</li> </ul>
Above-Ground Storage	<ul style="list-style-type: none"> <li>Moderate capital costs</li> <li>Moderate maintenance costs</li> </ul>	<ul style="list-style-type: none"> <li>Aesthetic issues</li> <li>Usually only feasible for collection from the roofs of buildings</li> </ul>

Source: (Metropolitan Council, 2011).

Storage elements can act as sedimentation basins to further remove particles from the stormwater. Fine filtration can be included at the effluent of the storage system to prevent clogging or fouling of irrigation equipment. In systems that irrigate unrestricted access areas, the stormwater will usually pass through a filter, followed by a disinfection process. Disinfection may consist of UV radiation and/or chlorination to neutralize pathogens that could impact public health.

An emergency spillway or overflow should be designed on any type of storage system to divert flow from conveyance, or allow storage to overflow when storage components are full. The emergency spillway or overflow may consist of a pipe or weir that discharges flow to the downstream stormwater conveyance system.

A stormwater reuse system typically requires a pumping system to move water from the collection or storage location to the use point, and to boost pressure for application. Stormwater should be sufficiently filtered to eliminate the risk of damaging pumping equipment prior to distribution.

Controls incorporated into stormwater capture and reuse systems will provide storage level monitoring to control pumping operations and storage fill/diversion operations, as well as source control. Systems may be designed to draw storage levels down in advance of storm events, to drain storage for maintenance, or to take systems off line. Level monitoring will also control diversion to overflow, as storage volumes fill during rain events. Consideration should also be given to either automatic or manual control of source switching, including proper cross contamination control, to use alternate supplies when storage volumes are depleted.

#### **COST ESTIMATING CONSIDERATIONS**

Estimated costs for construction of stormwater capture and reuse systems for urban irrigation applications were developed for this analysis. Capital costs include conveyance, treatment, storage and pumping components as well as engineering, legal, administration, and design contingencies. Costs do not include land acquisition or development costs. However, requirements for land area for each system size, and an estimate of annual O&M expenses were calculated.

Costs were developed in part through a review of literature on other stormwater reuse systems constructed throughout the United States. In the review of literature, the majority of stormwater reuse ponds were developed by modifying an existing stormwater pond. Costs for constructing a new stormwater reuse pond were developed by calculating the quantities and costs of three different sized hypothetical stormwater reuse pond designs. In the hypothetical designs, the stormwater reuse ponds were assumed to be five feet deep with 4:1 side slopes, have a 12-inch thick clay liner, 6-inch thick topsoil stripping and replacement, close proximity to existing stormwater conveyance, security fencing around the entire pond with gate access, and appropriate connection to an existing irrigation system. Costs for pond systems were based on construction costs obtained from recent bids on similar types of construction in Minnesota, quoted unit costs from RS Means, and unit costs from HDR historical costs on similar projects.

Some of the cost items associated with constructing stormwater storage ponds are associated with the existing soil conditions and whether or not the pond requires a clay liner, clearing and grubbing, excavation and hauling, proximity to the stormwater source, security, existing or new irrigation system, treatment and pumping costs, and landscaping and recreational features.

Costs for below ground and above ground storage systems, including manufactured tanks, cisterns, or constructed concrete chamber-type facilities were developed using historical costs on similar projects. Cost curves were developed to estimate costs for a range of system sizes.

For underground storage systems, cost items with the highest variability include excavation and hauling, conveyance of stormwater to the storage system, manufactured or cast-in-place storage system, paving materials at the surface, existing or new irrigation system, and treatment/pumping costs.

# Appendix A10: MCES Southeast Metro Sub-region Wastewater Reuse Concepts and Costs Memo

## Memorandum

**DATE:** Friday, September 12, 2014  
**TO:** John Chlebeck  
**CC:** Bryce Pickart  
**FROM:** Deborah Manning  
**SUBJECT:** Southeast Metro Sub-region Wastewater Reuse Concept and Costs

### Summary

Table 1 summarizes reclaimed water demand, water quality, and cost information for a proposed wastewater reuse plan for the Southeast Metro sub-region. Figures 1 through 3 present the service concept for each user category. The following sections provide background details.

Table 1. Proposed Southeast Metro Reclaimed Water System Summary						
Reclaimed Water User Category	Average Demand, mgd	Peak Demand, mgd	Assumed Water Quality	Capital Cost, \$M	Annual Add'l O&M Cost, \$M	Total Cost, \$/1,000 gal
Flint Hills Refinery	3	3	Disinfected Tertiary with Nutrient & Total Dissolved Solids Reduction	18	4	5
Residential & Commercial Toilet Flushing & Irrigation in Areas of Growth from 2010 - 2040	3	8	Disinfected Tertiary with Nutrient Reduction	98	1	8
Agricultural Irrigation North & East of Empire WWTP	4	10	Disinfected Tertiary with Nutrient Reduction	29	1	9
<b>Total</b>	<b>10</b>	<b>21</b>		<b>145</b>	<b>6</b>	

### Southeast Sub-Region Study Area

The study area consists of the Empire WWTP service area, focusing on the current and 2040 service area. See Figure 4. Based on the need to have significant reclaimed water demand potential near the Empire WWTP, this plan focused on the following cities in the Empire service area:

- Apple Valley
- Farmington
- Lakeville
- Rosemount.



### **Potential Reclaimed Water Users and Demand**

A database of all potential reclaimed water users in the Twin Cities Metro Area was initially developed. The following use categories in the database were identified as targeted users in the Southeast Metro sub-region:

- Industrial: Refinery cooling water (existing)
- Residential: Toilet flushing and irrigation for future (2010 – 2040) residential growth as identified in the Thrive projections
- Commercial: Toilet flushing and irrigation for future (2010 – 2040) commercial growth as identified in the Thrive projections
- Major Crop Irrigation Not for Human Consumption (existing)

Table 1 summarizes projected reclaimed water demand for each user category.

### **Reclaimed Water Quality**

Because of concern about existing nitrate contamination in southern Dakota County, MCES assumed that additional nutrient reduction would be provided for reclaimed water. Table 2 summarizes the reclaimed water quality goals for the anticipated users and water quality categories.

### **Reclaimed Water Distribution System Concept and Costs**

The reclaimed water distribution system concept was developed by reviewing the locations of potential users. For existing users (Flint Hills Refinery and agricultural irrigators), this effort was straight forward. Locations of future residential and commercial growth were determined using each community's *2030 Comprehensive Plan*.

The review of potential user locations led to the conclusion that a satellite treatment facility and dedicated pipeline would best serve Flint Hills. Facilities to serve residential/commercial users could be divided into 3 zones, as described below.

- Zone 1: serving Rosemount
- Zone 2: serving southeast Apple Valley and northeast Farmington
- Zone 3: serving eastern Lakeville and, potentially, southern Farmington

A separate distribution system would serve the agricultural irrigation east of the Empire WWTP.

Table 1 summarizes the capital, O&M and per billing unit costs by user category.

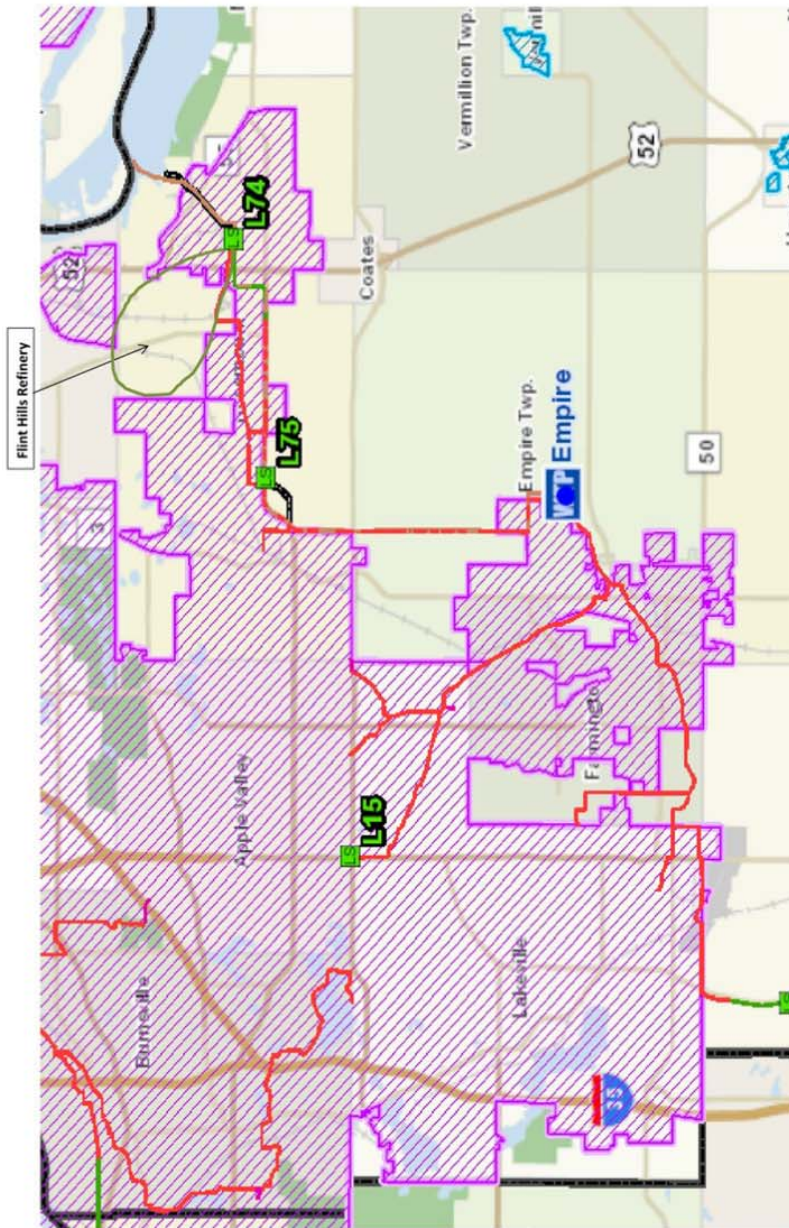
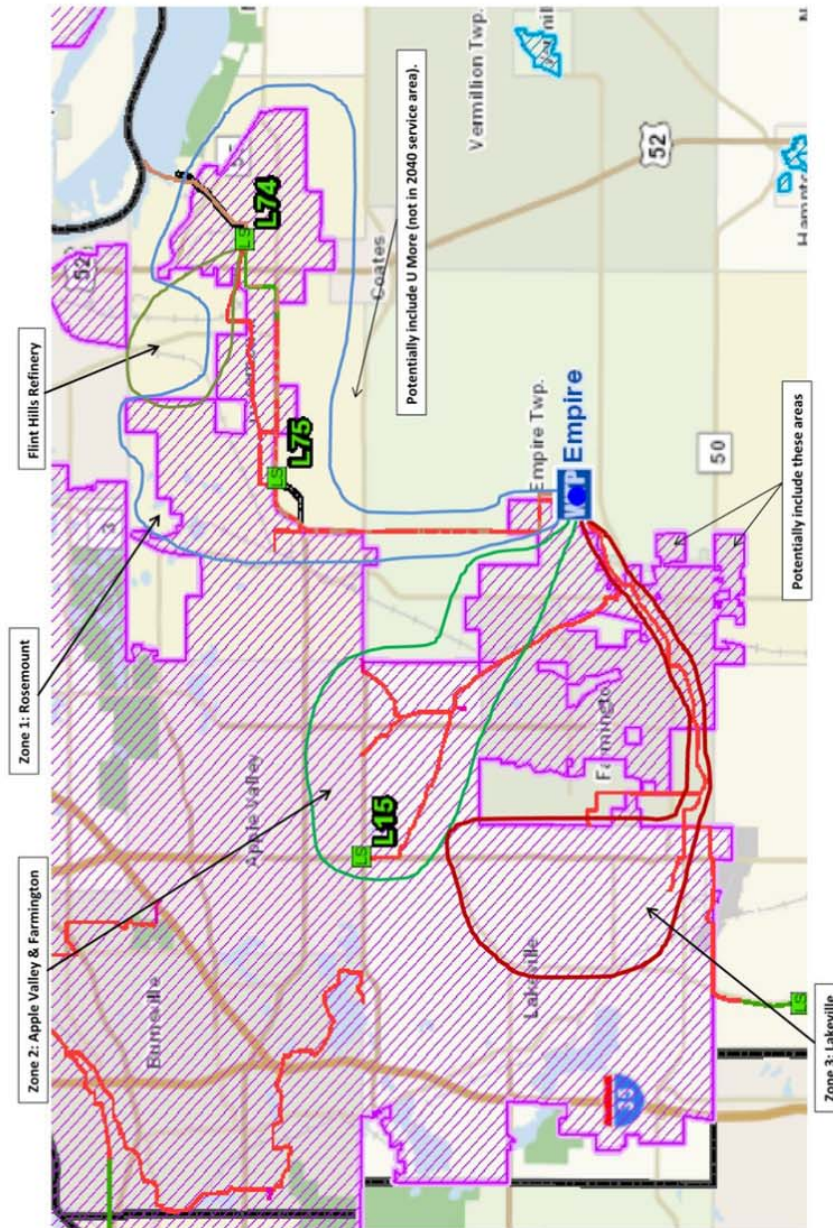


Figure 1. Flint Hills Refinery

**Treatment Approach**  
 -- Empire WWTP effluent is withdrawn from the Empire outfall near L74 (at the former Rosemount WWTP)  
 -- The effluent is treated at a satellite plant near L74  
 -- Treatment consists of membrane filtration, reverse osmosis, and enhanced chlorination via chlorination.  
 -- Reclaimed water is pumped to Flint Hills.  
 -- No change to the Empire WWTP treatment process is needed.





**Figure 2. Household & Commercial Toilet Flushing + Irrigation for 2010 - 2040 Growth**

**Treatment Approach**  
 -- Reuse facilities and service for Flint Hills continue via facilities previously described.  
 -- Treatment of a split stream at Empire WWTP is upgraded to provide disinfected tertiary reclaimed water with nutrient reduction. The split stream processes are: AZO, dual media filters, enhanced disinfection via UV and chlorination (for residual).  
 -- The reclaimed water is stored at Empire in new storage tanks and pumped to zones 1, 2, and 3.

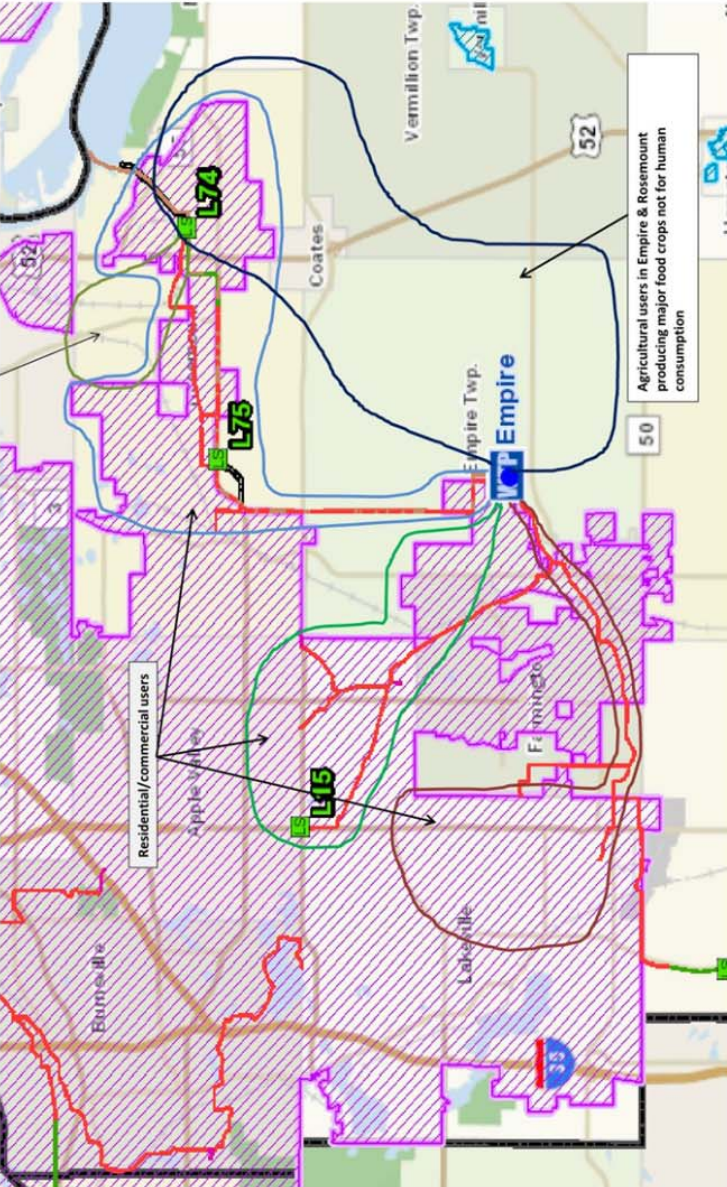
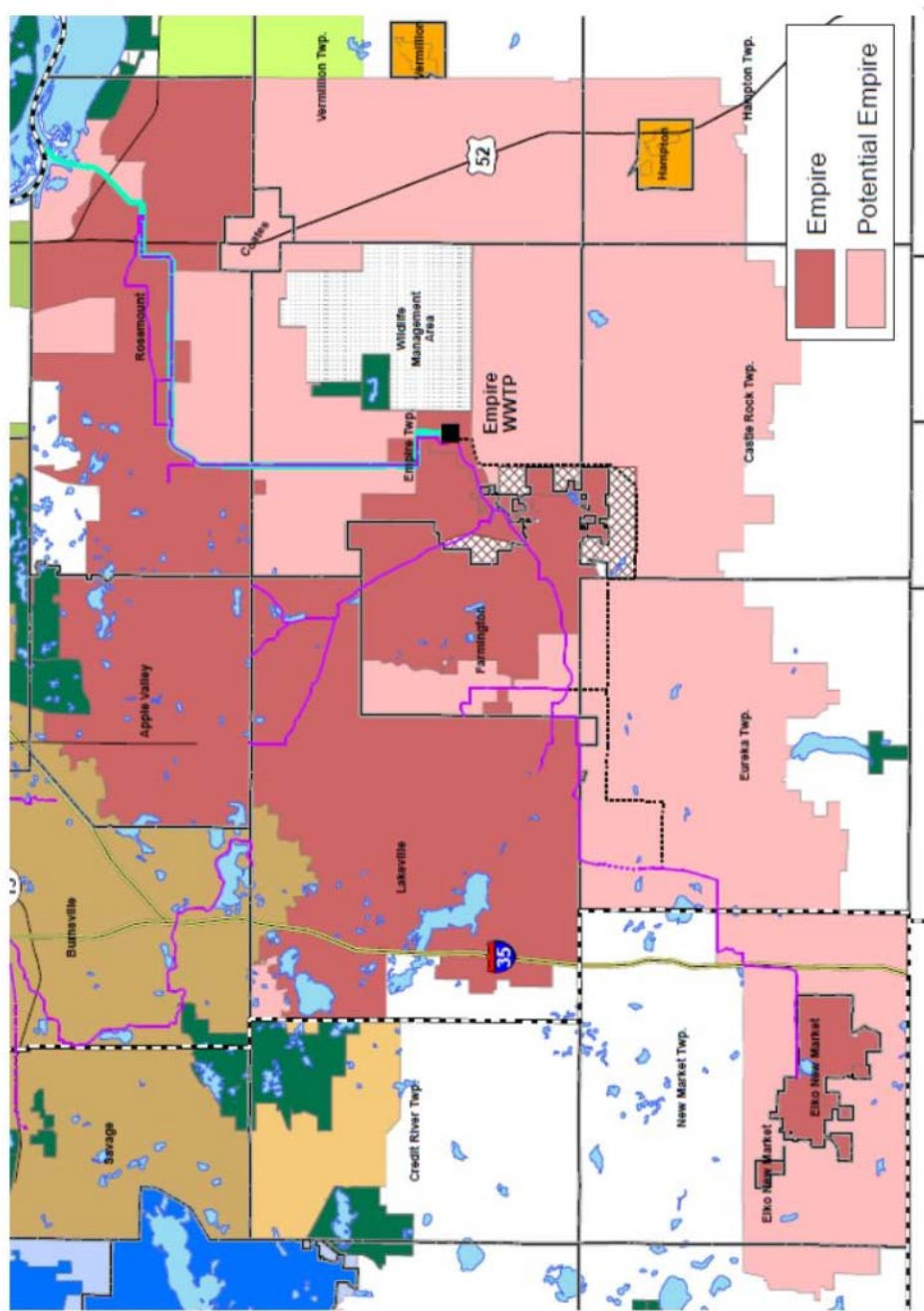


Figure 3. Major Crop Irrigation (Not for Human Consumption)

**Treatment Approach**  
 -- Facilities to serve Flint Hills & residential/commercial users continue via facilities previously described.  
 -- The treatment of a split stream at Empire WWTP is expanded to produce more disinfected tertiary reclaimed water with nutrient reduction to serve agricultural users producing major crops not for human consumption in the area east of Empire WWTP (Zone 4).  
 -- Additional storage and pumping is provided at Empire to serve these users.  
 -- The remainder of Empire WWTP flow continues to receive the current treatment.  
 -- Service to agricultural users in Empire Township and Rosemount is via Zone 4, shown. However, some users in the northern part of Zone 4 could be served

Figure 4. Empire Current (by 2040) and Long-Term (Potential) Service Area



**Table 2. Water Quality Category, Users, and Goals\***

Water Quality Category	Reclaimed Water Users	Treatment Processes and Location	Nitrate	Total Phosphorus	Total Coliform	Fecal Coliform	Total Dissolved Solids	Chloride
Disinfected Tertiary with Nutrient Reduction	Residential and commercial toilet flushing and irrigation, irrigation of major food crops not for human consumption	<b>At Empire WWTP:</b> A2O, dual media filtration, enhanced disinfection via UV and chlorine addition (for residual)	<10 mg/L (maximum monthly value)	<1 mg/L	<2.2 MPN/100 mL	<2.2 MPN/100 mL	2,000	500
Disinfected Tertiary with Nutrient and Total Dissolved Solids Reduction	Flint Hills Refinery cooling water	<b>At Satellite Treatment Plant:</b> Membrane filtration, reverse osmosis, enhanced disinfection via above processes and chlorine addition (for residual) <b>At Empire WWTP:</b> no change	<10 mg/L	<1 mg/L	<2.2 MPN/100 mL	<2.2 MPN/100 mL	<500 mg/L	200 mg/L

\* Treatment performance may exceed goals.

## **Appendix A11: Regional Implementation Planning Memo**

### **BACKGROUND**

The Council has retained the services of HDR to provide assistance with the identification of cost-sharing or financing structures that would promote financial equity within shared or semi-regional systems in the Twin Cities Metropolitan Area as a part of the Regional Feasibility Assessments project. This memo will summarize the institutional and financial structures or considerations associated with cost-sharing approaches identified from three examples of regional water system cost sharing arrangements. In determining the three case studies, HDR looked for systems where the dependence on groundwater needed to be reduced and where cost-sharing was occurring among various entities of varying sizes. Two systems with similar cost-sharing and financial approaches were identified in Texas. These include the San Jacinto River Authority – Groundwater Reduction Program Division and the West Harris County Regional Water Authority. The third example is the Woodlands-Davis Clean Water Agency in California.

### **GROUNDWATER IN THE STATE OF TEXAS**

Groundwater is a major source of water in Texas, providing about 60% of the 5.2 billion gallons of water used in the state each year to meet both irrigation and municipal demands. The Texas Water Development Board, created in 1957, is the State agency responsible for long-range water resource planning in the Texas. It conducts regional planning, administers the Texas Water Bank, and provides grants and loans for water and water resource projects throughout the state. The State's Groundwater Resources Division of the Texas Water Development Board (TWDB) collects, interprets and provides information on the groundwater resources in Texas. The TWDB monitors 9 major and 21 minor aquifers by conducting regional-scale groundwater modeling. It also reviews and approves groundwater management plans and participates in the establishment of desired future conditions of aquifers in groundwater management areas. Through the collection of groundwater data, the TWDB has identified aquifers with significant levels of decline. All of these water level declines have been shown to be the result of groundwater withdrawals, occurring primarily since the 1950s.<sup>1</sup>

In 1949, the Texas legislature passed regulations establishing groundwater conservation districts as political subdivisions of the state. The districts originated as a way of establishing local control of groundwater resources as opposed to state control. As of September 2010, there were 96 districts serving around 66 percent of the land area in Texas.<sup>2</sup> Texas Water Code Chapter 36 establishes the fundamental rules of a groundwater conservation district, and modifies the rule of capture. The rule of capture, prior to the modification, gave landowners the right to capture and beneficially use groundwater from their property without limits. The modifications in Chapter 36 respect private ownership rights but reserve the option of the conservation district to register, permit and establish production limitations or fees on the exploration and production of groundwater.

---

<sup>1</sup> Source: Texas Water Development Board website, <http://www.twdb.state.tx.us/groundwater/index.asp>

<sup>2</sup> Aquifers of Texas Report 380, Texas Water Development Board, July 2011

Chapter 36 states that districts must exempt wells capable of producing up to or equal to 25,000 gallons per day and that they may choose to increase that threshold limit. Not all groundwater conservation districts issued production permits, but in each district's drought management plan, required by legislation in 1997, the groundwater conservation districts established a total usable amount of groundwater in the district. Groundwater districts manage the groundwater use from aquifers within their respective service areas.

Creation of Groundwater Management Areas (GMAs) was authorized by the Texas Legislature in 1995,<sup>3</sup> and the responsibility to delineate GMA's was given to the Texas Water Development Board. Groundwater Management Areas were created "in order to provide for the conservation, preservation, protection, recharging and prevention of waste of the groundwater, and of groundwater reservoirs or their subdivisions, and to control subsidence caused by withdrawal of water from those groundwater reservoirs or their subdivisions." The TWDB has divided the state into 16 management areas and each area can have various groundwater districts within its boundaries. Some areas have no groundwater districts and some have as many as ten.

#### **SAN JACINTO RIVER AUTHORITY, CONROE, TEXAS**

The SJRA is one of ten major river authorities in Texas created in 1937 by the Texas Legislature<sup>4</sup>. Its mission is to develop, conserve, and protect the water resources of the San Jacinto River watershed. The SJRA watershed includes approximately 3,200 square miles in the counties north of the City of Houston. The SJRA's General and Administrative Offices are located at Lake Conroe. SJRA has four separate operating divisions: Lake Conroe Division, The Woodlands Division, Highlands Division and the Groundwater Reduction Plan (GRP) Division.

In 2001 the Lone Star Groundwater Conservation District (LSGCD) was created to help Montgomery County manage its dependence on the Gulf Coast Aquifer. The LSGCD, which is approximately 50 miles north of Houston, studied the Gulf Coast Aquifer for 10 years and confirmed that water levels in the county's aquifers were declining at an unsustainable rate, the result of deficit pumping. Additionally, water modeling of future groundwater supplies indicated to LSGCD that failure to reduce groundwater usage, water levels in the aquifer would continue to decline and would eventually spread to other parts of the county that were not previously affected. To deal with the deficit-pumping the LSGCD did the following:

- Calculated the amount of water the Gulf Coast Aquifer could yield in Montgomery County on a sustainable basis.
- Calculated the Total Qualifying Demand<sup>5</sup> of large-volume users and determined that current demand from those users exceeded the sustainable level.

---

<sup>3</sup> Texas Water Code §35.001

<sup>4</sup> Article 8280-121, as amended.

<sup>5</sup> Defined as the final volume of groundwater that a permit holder is authorized under the terms of a permit issued by the District to produce from the Gulf Cost Aquifer (Chico, Evangeline and Jasper aquifers) in calendar year 2009. Such final volume shall be determined by the District after receipt of water production reports due to the District on February 15, 2010.

- Called on large-volume users to create plans for conservation and the development of alternative water supplies. Conservation and development of surface water supplies were determined to be the most cost-effective options.
- Worked with all of its permit-holders and stakeholders to ensure a sustainable, cost-effective water supply for current and future needs. This work is ongoing.
- Continued to seek and analyze new data.<sup>6</sup>

The LSGCD charges permit fees to all groundwater users in the district and has disincentive fees for users that exceed their permitted amount. In order to address deficit-pumping, the LSGCD is requiring that all large-volume groundwater users (LVGUs) reduce groundwater usage by 30% based on 2009 usage. The LSGCD allowed for the creation of joint groundwater reduction plan groups where LVGUs could enter into contractual agreements to develop regional solutions to address the groundwater reduction requirements.

In response to these directives and as a treated water provider to LVGUs who hold permits with LSGCD, the San Jacinto River Authority (SJRA) created the Groundwater Reduction Plan Division (GRP)<sup>7</sup>. The GRP Division is responsible for implementing a county-wide program that will meet the requirements of the LSGCD to substantially reduce future groundwater usage from the Gulf Coast Aquifer by ensuring a reliable, long-term diversified portfolio of alternative water supply sources for all of Montgomery County.

Participation in the GRP was opened to all LVGUs in the county that include approximately 200 cities, utilities, and other water users. An LVGU is defined as an entity that has been authorized by a permit issued by the LSGCD to produce 10 million gallons or more of groundwater annually. Over 85 different entities representing over 140 water systems joined the GRP via individual contracts (GRP Contracts). In 2009, SJRA prepared a GRP Contract and sent it to the LVGUs who were subject to the LSGCD's regulations. By the end of July 2010, contracts had been executed by cities, utilities and other water providers representing more than 80 percent of the water use in Montgomery County.

---

<sup>6</sup> Lone Star Groundwater Conservation District, <http://www.lonestargcd.org/about-us/>

<sup>7</sup> The SJRA has four operational divisions – the Lake Conroe Division, the Woodlands Division, the Highlands Division and the GRP Division. The primary function of the Lake Conroe Division is the operation and maintenance of the dam, spillway structure, and service outlet at Lake Conroe. The Woodlands Division provides wholesale water supply and wastewater treatment services to 100,000-plus population of The Woodlands through the financing, construction, operation, and maintenance of three regional wastewater treatment plants, a wastewater conveyance system with numerous lift stations, five water plants, 38 water wells, several elevated and ground storage tanks and miles of wastewater collection and potable water distribution lines. The Highlands Division delivers raw water from Lake Houston and the Trinity River through an extensive 27-mile system of canals and a 456 million gallon staging reservoir in order to provide water to customers such as Exxon Mobil, Chevron Phillips Chemical Company and a number of other industrial, municipal, and agricultural customer pursuant to long-term water supply contracts.

By joining the GRP, those entities (the “Participants”) are able to achieve cost savings by utilizing a “group compliance” concept in which some Participants are converted to surface water while other Participants continue to use only groundwater, while still meeting the overall reduction goal of 30%. Cost, proximity to the proposed surface water treatment plant and water demands were used to determine which Participants would be converted to surface water. According to the GRP Final Report, various line segments were evaluated and present worth analyses were completed to determine which alternatives were recommended for implementation. The first phase solution provided by the GRP Division (Phase I) includes the construction of a surface water treatment facility and transmission system to provide treated surface water to seven (7) Participants. By providing treated surface water to these seven (7) Participants the aggregate groundwater usage for the SJRA GRP will be reduced. Other water supply strategies that may be developed in the future include, but are not limited to, development of untapped groundwater from the Catahoula Aquifer, reuse of treated wastewater effluent, and demand reduction through water conservation. It is anticipated that additional Participants will be added to the GRP in the future as growth occurs, and that supply to these Participants will depend on their demands and proximity to surface water supply infrastructure.

The GRP Division and SJRA Technical Services oversee, as a team, the GRP program that will allow a significant portion of Montgomery County to reduce its groundwater usage. Any LVGUs that have not joined the GRP must still meet the requirements of the LSGCD on an individual basis. As part of the SJRA, the GRP Division benefits from SJRA’s long-standing purpose of providing long-term, regional water supply projects. The GRP Division, as an operational division of SJRA, must be self-sustaining and must operate on a cost-neutral basis. In order to operate on a cost-neutral basis, the GRP Division must cover all operating expenses and debt service of the surface water and transmission system as well as cover its allocated portion of SJRA’s general and administrative costs. The Participants, currently made up of 140 water systems, will receive water from the SJRA GRP Division on a wholesale basis.

The strategy of the Phase I system is to convert those Participants with the highest volumes of groundwater demand to surface water. The Participants include City of The Woodlands, City of Conroe, Montgomery County Water Control and Improvement District No. 1, MSEC Enterprises, City of Oak Ridge North, Southern Montgomery County Municipal Utility District, Rayford Road Municipal Utility District and Montgomery County Municipal District No. 99. These Participants will receive surface water, but will continue to rely on their existing groundwater wells to meet peak demand. The other Participants will remain solely dependent on groundwater sources. Phase I is projected to be in service by January 2016.

### Financing

SJRA accessed capital financing for the design and construction of Phase I (surface water treatment plant and transmission system) through the Texas Water Development Board. The SJRA issued approximately \$552 million in bonds between 2009 and 2013 to fund elements of the Phase I project. Of that, approximately \$469 million in bonds were issued through the Texas Water Development Board (TWDB) and about \$83 million in the open market.



It is anticipated that a final bond issue in the amount of approximately \$12 million may be required to complete the project. By accessing funds through the TWDB, SJRA was able to secure low-interest loans through the TWDB's Water Infrastructure Fund (WIF) and Development Fund II (DFund II) programs and reduce bond funding costs. This was important for reducing the ultimate cost of the facilities.

The WIF program provides financial assistance for planning, design and construction of projects identified in the State's most recent Water Plan. The State Water Plan identifies water supply needs of the state and is updated every five years. Loans through this program offer a subsidized interest rate that is currently 100 basis points below the TWDB's cost of funds.

The DFund II program is a state-funded loan program that does not receive federal subsidies. Loans can be used for planning, design and construction for water supply projects, including water treatment plants and wholesale transmission lines. Interest rates for this program are set a 0.40 percent above the TWDB's borrowing cost. Because the underlying bonds for this program are issued by the TWDB utilizing the state's credit, the interest rate can be favorable for many entities.

### Rates

One of the challenges in implementing this system is defining a rate system that balances costs between all the Participants, including those that will continue to rely solely on groundwater systems and those that will be converted to surface water to meet base demands. Because development of a surface water source will improve the conditions of the aquifer and provide long-term reliability and benefits to all groundwater users in the region, all Participants will pay into the cost of the facilities, but at rates that are designed to reflect benefit derived from the system. Under this structure, both groundwater and surface water users will support the SJRA surface water system.

The model for rate design and revenue generation is based on the concept that Participants will pay for service based on actual groundwater pumped and surface water delivered. Initially, until the surface water treatment plant and transmission system is in service and delivering surface water, the system will be fully supported by the groundwater pumpage fee as established by the SJRA Board. After beginning the delivery of surface water, SJRA will collect revenues through a groundwater pumpage fee and a surface water rate. The groundwater pumpage fee is charged to customers based on the amount of groundwater pumped from their individual wells. The surface water rate is charged to customers based on metered surface water delivered to their system.

Since the creation of the GRP division, costs have been incurred by the SJRA. These costs include the administration of the division and debt service on the outstanding bonds. It is estimated that construction of the surface water treatment plant will be completed in early 2015 and that surface water will be delivered on or about September 1, 2015. As construction is completed, the GRP will begin to incur additional expenses related to the start-up of the surface water treatment plant, including but not limited to labor, chemicals, electricity and purchased water costs.

Because surface water will not be delivered during this time, revenue from the sale of surface water will not be collected. During this time, revenues generated from groundwater pumpage fees will solely be supporting the operations of the GRP division.

In developing the rate structure, consideration was given to the types of customers that would be served: (1) Participants that will remain entirely on their existing groundwater systems, and (2) Participants that will be converted to surface water for base demands and will use existing groundwater sources to meet peak demands. To balance revenue generation from these two groups, two rates, a groundwater pumpage fee and a surface water rate were calculated. A third cost component, the differential cost between groundwater and surface water use, is factored into the calculation of the groundwater pumpage fee and the surface water rate. The concept assumes that by receiving surface water, the participant will “avoid” certain groundwater costs that would have otherwise been incurred. This means that both customer groups should ultimately incur a similar cost per 1,000 gallons no matter the type of water used. This concept became the basis for calculating the difference between the two rates.

In calculating the “avoided groundwater pumpage cost,” SJRA surveyed a group of participants that included a mix of large, medium and small-volume water users. The survey requested information regarding historical groundwater O&M costs incurred by their water supply systems for fiscal years 2009 through 2013. This information was used to calculate an avoided groundwater pumping cost factor to adjust the groundwater pumpage fee to produce a surface water rate that would achieve general unit cost equity between the conjunctive surface-groundwater users and groundwater-only users. While the amount of groundwater costs incurred by utilities may vary, the types of costs incurred are similar.

SJRA received responses from four utilities. Each respondent provided cost data related to the O&M of their respective systems. Most of the costs submitted by each respondent included total labor, maintenance, utilities, chemicals and laboratory services. Of these, costs related to chemical use, fuels and lubricants, well pump maintenance and electric utility expenses were identified as costs that would likely be reduced with less groundwater use. A groundwater pumpage reduction of 60% was determined using the weighted average percentage of groundwater usage that will be converted to surface water. This percentage was applied to the total avoided costs.

The avoided well-related costs were then converted to a cost per 1,000 gallons based on the participant’s groundwater pumpage. The weighted average cost per 1,000 gallons for all survey respondents resulted in \$0.19 per 1,000 gallons.

The resulting groundwater pumpage fee and surface water rate are \$2.25 per 1,000 gallons and \$2.44/1,000 gallons, respectively. The groundwater pumpage fee is applied to the amount of groundwater pumped by each Participant and the surface water rate is applied to the actual amount of surface water delivered. The revenue generated by these rates will cover the total cost of the surface water treatment plant and transmission system, including capital costs, operations and maintenance expenses and debt service on the outstanding bonds, as incurred by the SJRA GRP Division.

In addition to these fees, it has been proposed that SJRA become the collector of the LSGCD permit fee as a pass-through fee to the Participants. In addition, to the extent the groundwater withdrawals exceed the SJRA's and each participant's permitted groundwater amount, a disincentive fee will be incurred and paid to the LSGCD. The disincentive fee of \$7.00 per 1,000 gallons will be charged by LSGCD to the extent that the permitted amount is exceeded. As a group, the GRP Participants will have to maintain its groundwater pumping to an amount below the total permitted amount.

#### **WEST HARRIS COUNTY REGIONAL WATER AUTHORITY, HOUSTON, TEXAS**

In the early 1940s, studies of the Houston/Galveston area, located in Southeast Texas, showed increasing problems due to groundwater extraction from the Chico and Evangeline aquifers. Between 1950 and the early 1970's experiences and studies indicated that groundwater withdrawals were contributing to land subsidence<sup>8</sup> in the area. By 1973, the City of Galveston had begun converting from groundwater supply to surface water, supplied from Lake Houston, to address the subsidence issue, and in 1975 the Harris Galveston Subsidence District (HGSD) was created by the Texas Legislature to address the continued impacts of groundwater pumping on land subsidence. To accomplish its statutory purpose, the HGSD is authorized to regulate the amount of groundwater withdrawn from local aquifers. This requires conversion of some portion of groundwater demands to surface water supplies. Early efforts to convert groundwater users to surface water stabilized subsidence in the coastal areas, but groundwater levels further inland in areas north and west of Houston continued to decline. In the Evangeline aquifer, a decline of more than 100 feet was documented between 1977 and 1997. As a result of the increasing subsidence in these areas, the HGSD adopted a series of regulatory plans to further reduce groundwater pumpage.

In response to the regulatory plans of the HGSD, the West Harris County Regional Water Authority (Authority) was created by the Texas Legislature in 1999 and signed into law in May 2001 to transition the area to surface water supply within a set timeframe. The service area of the Authority is generally located in Southeast Texas in West Harris County, Waller County and Fort Bend County. The Authority was created to provide for:

- The provision of surface water and groundwater for various uses;
- The reduction of groundwater withdrawals;
- The conservation, preservation, protection, recharge and prevention of wastewater of groundwater and of groundwater reservoirs;
- The control of subsidence caused by withdrawal of water from those groundwater reservoirs.<sup>9</sup>

There are currently 120 municipal water providers within the boundary of the Authority, which is managed by a nine-member Board of Directors. The empowerment act of the Authority allows for the collection of rates, fees and charges, special assessments, notes, bonds and capital contribution from municipalities or utility districts within its boundaries.

---

<sup>8</sup> Land or Groundwater Subsidence is the sinking of land resulting from groundwater extraction.

<sup>9</sup> Source: <http://www.whcrwa.com/about-whcrwa/creation-and-background/>

The Authority's Groundwater Reduction Plan (GRP), as required by the HGSD, establishes the Authority's responsibility to manage the HGSD-mandated conversion to surface water. In addition to the 120 municipal water providers and the City of Katy within the Authority boundaries, there are seven municipal utility districts located outside the boundaries of the Authority which are required to comply with the GRP requirements. The total water demand of these users in 2009 was approximately 21 billion gallons (average demand of 57.5 MGD). The GRP requirements include a 30 percent reduction in groundwater use in 2010, 60 percent reduction by 2025 and 80 percent reduction by 2035. As part of this plan, the HGSD adopted a disincentive fee of \$7.00 per 1,000 gallons for those water providers failing to comply with these reductions.

The initial phase of the plan included negotiating a long-term contract with the City of Houston and the construction of numerous transmission projects to supply treated surface water to utility districts within the GRP. As of early 2014, the Authority is delivering surface water to 53 water plants, with 40 districts, or approximately 36 percent of all districts, converted. The Authority has a Capital Improvement Plan that includes the construction of additional transmission water lines to the remaining utility districts as mandated by the GRP. It is estimated that the Authority will deliver an estimated 68.7 MGD of surface water by 2030.

The Authority charges fees for surface water delivered by the Authority and for groundwater pumped by various groundwater users. In addition to the construction of infrastructure and conversion to surface water supply, the Authority is very active in the promotion of water conservation through education programs for public schools and area residents. The groundwater and surface water rates charged by the Authority fund the initial infrastructure improvements and will continue to cover the operations and maintenance expenses, debt service requirements and bond covenants of the water delivery system, as well as construction of future infrastructure. The Authority only operates the transmission system and does not operate any surface water treatment plants. The City of Houston, who the Authority purchases treated surface water, is the owner and operator of the surface water treatment plants.

### Financing

The Authority financed its purchase of a portion of the City of Houston's treatment plant capacity, construction of a treated water transmission system, and costs associated with the design and construction of the Authority facilities with capital contributions from utility districts and by issuing bonds. The bonds issued are payable from rates and charges collected by the Authority. The rates and charges also pay for operation and maintenance of the transmission facilities, administration of the Authority and debt service. The Authority has been collecting a groundwater fee since 2001 and began collecting a surface water rate in 2005, when conversion to surface water supply began.

## Rates

Like SJRA, the Authority has developed a similar rate structure where all water users within the area will pay a share of the costs to build and maintain water delivery infrastructure and for the supply of surface water from the City of Houston system. As of 2014, the groundwater and surface water rates charged to the water providers are \$1.90/1,000 gallons and \$2.30/1,000 gallons, respectively. All non-exempt<sup>10</sup> well owners within the boundaries of the Authority, including private, industrial and municipal water suppliers, must pay the groundwater reduction plan fee. The surface water rate is paid by all entities that receive surface water. In addition to the groundwater pumpage fee and surface water rate, the Authority has an Imported Water Fee that is the same as the surface water fee. As defined in the Rate Order, Imported Water means water (whether surface water or groundwater) that is produced outside of the boundaries of the Authority and transported into the boundaries of the Authority for distribution to an end user within the boundaries of the Authority. As of March 2013, the groundwater reduction plan fee is \$1.90 per 1,000 gallons of water pumped from each non-exempt well, the surface water fee is \$2.30 per 1,000 gallons of surface water received and the imported water fee is equal to the groundwater reduction plan fee if the system has not been connected or equal to the surface water fee if the system has been connected to the Authority's system.

### **WOODLAND-DAVIS CLEAN WATER AGENCY, WOODLAND AND DAVIS, CALIFORNIA<sup>11</sup>**

In September 2009, the neighboring cities of Woodland and Davis, California created the Woodland-Davis Clean Water Agency (WDCWA), a joint powers authority, to implement and oversee a regional surface water supply project. Both cities have been dealing with water supply and wastewater discharge issues related to degrading groundwater quality, and have concluded that a jointly-owned and operated surface water system is the best alternative to address long-term water supply and wastewater disposal needs.

The Cities of Woodland and Davis, California, have depended on groundwater for water supply since the 1950's. At that time, the quantity and quality of the water were sufficient to meet the needs of the region. Over time, the quality of the groundwater has declined to the point where the water supply system will not be able to meet state and federal drinking water quality standards, and the wastewater generated by water users will not meet anticipated wastewater discharge regulations. The groundwater contains high levels of nitrate, and it is anticipated that the system will not be able to meet proposed water quality standards for other constituents. Further, high salinity concentration in the source water may have adverse impacts on receiving waters. Failing to make improvements to the water supply and wastewater treatment systems could result in increased costs related to the degrading groundwater supply including regulatory fines for violations of state and federal water quality and wastewater discharge standards.

---

<sup>10</sup> An Exempt Well, as defined in the Authority Rate Order, dated March 13, 2013 is a well with a casing diameter of less than five inches that solely serves a single family dwelling or a well that is not subject to any groundwater reduction requirement imposed by the HGSD.

<sup>11</sup> Source: [http://www.wdcwa.com/our\\_water](http://www.wdcwa.com/our_water)

In California, the State Water Resources Control Board (the State Water Board) was created by the Legislature in 1967 to ensure the highest reasonable quality for waters of the State, while allocating those waters to achieve the optimum balance of beneficial uses. In addition, there are nine Regional Water Quality Control Boards (Regional Boards) that are guided by the State Water Board to develop and enforce water quality objectives and implementation plans that will best protect the beneficial uses of the State's waters. Regional Boards develop "basin plans" for their areas.<sup>12</sup> Through the Porter-Cologne Water Quality Control Act of 1969, each Regional Board is required to adopt a water quality control plan for all the areas within the region that establishes water quality objectives to ensure the reasonable protection of beneficial uses within the basin.

After more than two decades of study, the Cities identified two possible solutions to address the water quality issues:

- Develop a new, higher-quality water supply; or
- Install a new wastewater treatment process.

In evaluating both options, a regional surface water treatment plant was determined by two independent studies to be the most cost-effective option, and the option that would provide the most reliable water source over the long term. As part of the evaluation, both cities incorporated citizen committee input throughout the study period to provide an additional perspective about the project. Recommendations from the citizen committees were presented to each of the city councils.

The system, which will be put into service in 2016, will provide treated surface water from the Sacramento River to the Cities of Davis and Woodland through dedicated service lines. Water will be diverted from the Sacramento River through a 45,000 acre-foot (14.67 billion gallon) year-round water right secured from the State Water Resources Control Board by the WDCWA in 2011. Because the water rights agreement is subject to restrictions on diversions during summer months and dry periods an additional water right for 10,000 acre-feet of summer water was purchased from the owners of Conaway Preservation Group, an established wildlife ranch in the Woodland area. This additional water right will enhance water supply during summer months and other dry periods when diversions under the primary water may be curtailed. Both Woodland and Davis will maintain some groundwater production capacity for use when surface water supply is not able to meet demands, and the WDCWA is investigating the use of aquifer storage and recovery (ASR) to further enhance treated supply.

The project will include a jointly-owned and operated raw water intake, surface water treatment plant and transmission system. Within the existing water supply systems of Woodland and Davis, improvements will include distribution lines, water storage tanks and booster pump stations. The water treatment facility will supply up to 30 million gallons per day (MGD) of water with an option to expand to 34 mgd in the future.

---

<sup>12</sup> Source: [http://www.waterboards.ca.gov/about\\_us/water\\_boards\\_structure/index.shtml](http://www.waterboards.ca.gov/about_us/water_boards_structure/index.shtml)

Of the 30 mgd, Woodland's share will be 18 mgd and Davis' share will be 12 mgd. In addition, both cities are looking at other water supply strategies. Woodland is moving forward with an ASR system where surplus winter water from the Sacramento River will be stored in a groundwater basin beneath Woodland for later use. Davis will begin using lower-quality wells to irrigate its parks and greenbelts. Both cities are enhancing their water conservation plans to ensure that water resources are maximized throughout the region.

The WDCWA is governed by a four-member Board of Directors appointed by the Cities of Woodland and Davis. The agency's board consists of two city councilmembers from each city, along with one non-voting representative each from the Yolo County Board of Supervisors and University of California Davis (UC Davis). The Yolo County Board is involved in the project because of its interest and role in county-wide water planning, management and coordination. It is a potential funding partner and may provide water supply to the project. UC Davis may receive water from the project in the future.

Through this joint effort, the authority was able to access state funding for the construction of the plant. Construction of the project began in April 2014 and when completed will serve more than two-thirds of the urban population of Yolo County, CA, which has a population of about 200,000. UC Davis has an option to purchase 1.8 MGD of the system's 30 MGD capacity in the future made possible through a 2010 agreement with the WDCWA.

### Financing

The total capital cost estimate for the system is \$228 million. The original engineering cost estimate from June 2009 was \$350 million. The cost estimate, and resulting impact to rates, was reduced by accessing state and federal funding, partnering with neighboring utilities to jointly finance, construct, own and operate the intake facilities, using a design-build option for the facilities and reduced design capacity of the facilities based on refined studies of current and future demands for water. One such partnership with Reclamation District 2035<sup>13</sup> resulted in a historic urban-ag partnership on the construction of the water intake facility in the Sacramento River for which \$34 million in state and federal grant funding is being pursued. Per the Joint Powers Agreement, Davis will get a capacity share of 12 mgd and Woodland will get a capacity share of 18 mgd. The Agreement between the cities defines how costs will be divided among the two cities and who will operate each component of the system.

### Rates

The Agency will collect revenues for the system to cover operations and maintenance expenses and capital costs (debt service). According to the Amended and Restated Woodland-Davis Clean Water Agency Joint Powers Agreement costs incurred by the Agency in carrying out its functions will be allocated between the project participants pursuant to the agreement.

---

<sup>13</sup> Reclamation 2035 is a water conservation district located in Yolo County that delivers to landowners within its service area water for irrigation and other purposes. It currently operates an intake facility on the river that needs improvements.

Capital costs incurred prior to July 1, 2013 are allocated based on each participant's capacity amount in the system which results in a 46.1 percent share for Davis, and a 53.9 percent share for Woodland. Any technical, transmission or individually-owned project components are covered by the individual cities (and UC Davis in the future). Capital costs incurred after July 1, 2013, are modified slightly to consider additional components which are split 40.8 percent and 59.2 percent between Davis and Woodland, respectively. All fixed operating costs are allocated based on a 50/50 share. Variable operating costs, including operating, repair and replacement costs are allocated based on each participant's use of the project facilities on volume basis. Repair and replacement costs relating to transmission piping will be allocated only to the project participants based on service derived from particular transmission piping. Any supplemental water purchase costs will be allocated using the 46.1% and 53.9% for Davis and Woodland, respectively

If UC Davis opts to participate in the project in the future, a portion of the costs will be allocated based on actual volume used. If this occurs, the allocation percentage for Davis and Woodland will be recalculated taking into consideration UC Davis' capacity share in the project.

The Agency has agreed to finance and build facilities in the future and the entity (Woodland, Davis, or UC Davis) benefitting from that facility will be responsible for the costs related to that facility.

All costs of the Agency will be annually charged to Davis and Woodland to recover the Agency's annual budget, as approved by the Agency Board, based on the allocations discussed above. Each year, the Agency will conduct a "true-up" to determine if costs have been recovered. Any reconciling amount will be included in the budget for the next fiscal year.

#### **SUMMARY AND DISCUSSION**

In reviewing the three case studies, several common points can be identified in the development of diversified water supplies and regionalized or jointly-operated systems. These include:

- **Identification of the Problem:** A clear identification of the necessity to limit the dependence on groundwater through monitoring, modeling and studying of the aquifers;
- **A Driver to Reduce Groundwater Use:** Establishment of the limits on groundwater use either through legislative directives or through contracts;
- **Alternatives Analysis:** Feasibility studies of regional and stand-alone solutions for addressing the reduction of groundwater use.
- **Regional Approaches:** Regional approaches were shown to be cost-effective, and resulted in additional financing opportunities. Regional approaches were also instrumental in promoting equity among all resource users.
- **Demand Reduction Strategies:** Consideration of conservation efforts for reducing groundwater use;
- **Cost Reduction Strategies:** Consideration of financing tools including partnerships, access to low-interest loans, and federal and state grant funding to reduce the overall costs of the systems;



- ***Transparent Methods for Allocating Costs to Project Beneficiaries:*** Development of rate structures that generate revenue from both groundwater and surface water users to pay costs associated with diversified supply systems.

In all cases, there was a clear identification of resource reliability issues associated with continued use of groundwater. In the two Texas examples, the TWDB is the State agency responsible for overall monitoring and management of the State's water resources. The conservation (or subsidence) districts have a clear role to monitor and study the resources within their jurisdiction, and have the authority to implement resource management programs.

The San Jacinto River Authority and the West Harris County Regional Water Authority had requirements for the reduction of groundwater placed upon them by their respective groundwater conservation districts. The groundwater conservation districts, Lone Star Groundwater Conservation District and the Harris-Galveston Subsidence District, were given authority to monitor and issue groundwater permits by the state legislature. This authority resulted in the ability to limit the use of the groundwater. The LSGCD established a requirement of a 30% groundwater reduction to the groundwater used in 2009 by permit holders. The HGSD established a 30% groundwater reduction in 2010.

In the California example, the need to convert to surface water was prompted as much by water quality issues, as by long-term reliability of the groundwater source. Poor water quality and the projected costs associated with treating water of declining quality led to the study of alternative water supplies. The groundwater quality was also tied to wastewater treatment costs and discharge issues.

For each of the examples, solutions developed over several years of study and coordination. In each case several technical studies were completed to identify the appropriate limitations of groundwater and then later to identify the proper solution for the area. In each of the case studies participation in the overall plan was affected by the identified need for supply diversification, and the overall pressure, or driver, to address the need.

Conservation and demand reduction strategies are part of the overall water supply solution in all of the case studies. In Texas, both water management authorities have included demand reduction strategies as a component of reducing future demands toward meeting groundwater withdrawal limitations. Demand reduction will, in effect, reduce the projected size and cost of water supply facilities that will be needed to meet demands. In the Woodland-Davis case, conservation will not be able to address the water quality issues, but will positively affect capital and operating costs in the long-term by reducing the design capacity for new facilities and reducing both peak and annual water production volumes. Both cities are working towards a state requirement of reducing per capita demand by 20 percent by 2020.

In every case study, regional, cooperative agreements were an important part of the water supply solution. In the San Jacinto River Authority example, a standard agreement describing the project and the methodology for rates and outlining the requirements of each participant was executed by each GRP participants. This agreement gave the SJRA the authority to be the regional provider.

For the West Harris County Regional Water Authority, the creation of the district by the legislature mandated that all water providers in the service area of the Authority would be subject to the rules and regulations of the WHCRWA.

In the Woodland-Davis example, Yolo County's role in integrated regional water planning and in securing water rights to withdraw water from the Sacramento River provided Woodland, Davis, and the Reclamation 2035 conservation district with an opportunity to share ownership of a single river intake. The unique partnership created an opportunity for the project to apply for state and federal grant funding for the intake structure. Planning for potential service to UC Davis further promotes beneficial use of a regional resource.

In all cases, cooperation among several parties, including project partners, regulatory and planning agencies, and citizens was required to achieve the goal. This cooperation and involvement of all stakeholders is important in any regional effort, and especially when the solution may result in significant changes to utility ownership, operations, and rate payer costs.

When regional facilities are constructed, it is also highly important that the water rates are fair and reasonable and that they appropriately reflect the cost of service to all beneficiaries of the project. In the two Texas examples, equity among ratepayers was addressed through the revenue generation from both groundwater and surface water users within a water management area, and transparent determination of these rates. In these cases, the conversion of some portion of demands to surface water will have an overall benefit on the regional groundwater resource, alleviating pressure on the groundwater resource and allowing many users to maintain their groundwater systems. The groundwater and surface water charges allow for the collection of revenues from all water users, which will fund costs associated with the surface water system. In the Woodland-Davis example, costs for project components are allocated according to service derived from those facilities on a construction cost and demand percentage basis. By using each entity's proportionate share of capacity or volume usage as a basis of cost allocation, each entity's cost is defined based on the level of service received by the facilities.

#### **WATER SUPPLY PLANNING AND MANAGEMENT IN MINNESOTA**

In Minnesota, water use appropriations are managed by the Minnesota Department of Natural Resources (MnDNR). The MnDNR has the authority to develop and manage waters of the State to, "assure an adequate supply to meet long-range seasonal requirements for domestic, municipal, industrial, agricultural, fish and wildlife, recreational, power, navigation, and quality control purposes."<sup>14</sup> The MnDNR monitors water resources including streamflow and lake levels and operates a network of groundwater monitoring wells to identify trends in water resource availability.

The MnDNR also permits groundwater and surface water uses through the state appropriation permit process. Water appropriation permits are required in Minnesota for all water uses that exceed ten thousand gallons per day or one million gallons per year<sup>15</sup>.

---

<sup>14</sup> Mn Statutes 103G.265

<sup>15</sup> Mn Statutes 103G

The MnDNR has historically modified all permit changes requested by municipalities without study or technical determination of safe yield. Monitoring of aquifer levels may be but are not routinely required as part of an appropriation permit issue.

Additionally, the MnDNR Commissioner has the responsibility for allocation and control of waters of the state<sup>16</sup>. In order to safeguard water availability for natural environments and downstream higher priority users, Minnesota law requires the MnDNR to limit consumptive appropriations of surface water under certain low-flow conditions. State Statute 103G.261 establishes a priority system for consumptive appropriation and use of water, with domestic water supply taking first priority, and encourages the treatment and reuse of water. State Statute 103G.261, Subdivision 2(c) encourages the appropriation of surface waters during periods of high flows. However, beyond these specific provisions, and the establishment of allocation priorities, there is not a legislative declaration that surface water use is to be encouraged over ground water use for public water supplies.

Legislation passed in 1990 included modifications to State Statute 103G that restricted the use of the Mt. Simon-Hinckley aquifer to potable use and required the removal/conversion of once-through heating/cooling systems that use more than five million gallons per year.

Statute 103G.265 gives the MnDNR Commissioner the authority to establish water appropriation limits to protect groundwater resources, and to designate groundwater management areas and limit total annual water appropriations within these areas. The MnDNR has not traditionally limited groundwater withdrawals although uses have been curtailed according to the established priorities during dry periods. The MnDNR is currently developing a framework for developing groundwater management areas using three pilot areas in the State, including one in the north and east metropolitan area in response to declining surface water and ground water levels. These trends are being studied in relation to groundwater pumping in the area. If future limits on the amount of groundwater available for use are imposed, it is thought that these limits will come from the MnDNR, given their authority to permit water uses through the appropriation process.

Minnesota Statute 103G.291 requires all public water suppliers serving more than 1,000 people to develop a water supply plan, which must address projected demands, the adequacy of the water supply system, natural resource limitations, water conservation, and demand reduction measures, among other things. Water suppliers are required to encourage water conservation by employing water use demand reduction measures before requesting approval for new wells, or increases in permitted appropriation volumes. However, there is not a targeted demand reduction required as part of conservation planning requirements. If the governor declares a critical water deficiency, public water suppliers must adopt and enforce water conservation restrictions that limit lawn sprinkling, vehicle washing, golf course and park irrigation, and other nonessential uses, and have penalties for noncompliance.

---

<sup>16</sup> MN Statutes 103G.255

The Council has statutory authority to plan for future water supply needs in the metropolitan area<sup>17</sup>. The Council produced a Metropolitan Area Master Supply Plan in 2010, and is updating the plan in 2015 as a long-range plan to guide water supply development in the area. The Council has developed a regional groundwater flow model for the Twin Cities area that is available to assist with regional water supply planning. In the metro area, the Council comments on the MnDNR appropriation permit modification requests by municipal water suppliers and on demand reduction measures listed as part of the water supply plans. Additionally, regional soil and water conservation districts and local watershed districts are offered an opportunity to review and comment on water appropriations.

While the Council has a role in planning for water supply in the Metropolitan Area, and the MnDNR has authority to appropriate waters of the state for various uses, there is not a comprehensive statewide study or effort that considers or establishes long-term sustainable yields for water resources.

In 2013, the Minnesota Legislature approved \$2,537,000 from the Clean Water Legacy fund for the evaluation of the reliability and sustainability of the water supply for the Twin Cities metropolitan area<sup>18</sup>. As part of these evaluations, the Council is assessing regional water use issues and identifying potential solutions to help address emerging sub-regional water supply issues. As part of these evaluations, the technical feasibility of sub-regional water supply systems is being evaluated. Although there are several examples of shared, or semi-regional systems in the Twin Cities area (the Joint Powers Water Board serving Albertville, Hanover and St. Michael; the Joint Water Commission serving Crystal, Golden Valley, New Hope), and several retail or wholesale arrangements between cities, most notably the City of Minneapolis and Saint Paul Regional Water Services, the majority of the area is served by traditional independent municipal water supply systems.

Minnesota Statutes Section 110A allows for the establishment of rural water districts in all areas of Minnesota with the exception of Anoka, Carver, Dakota, Hennepin, Ramsey, Scott and Washington Counties. The Districts may be established for the conservation, distribution, storage and use of water for all purposes except irrigation. The Districts have the ability to appropriate both surface and ground water to meet customer demands. Rural water districts may also buy and sell water to other districts and municipalities as provided for in statute section 110A. In general, rural water districts have a great deal of authority to enter into contracts, construct public works for water supply and distribution, and to establish an annual and long-term operations plan. However, under Minnesota Statutes Section 110A.28, Subdivision 7, districts have no power of taxation or of levying assessments for special benefits. Districts may incur expenses by contract only and expenses are prorated to water users by volume of use of water supplied by the District. Districts may obtain grants and loans from state and federal agencies and may accept gifts, deeds or instruments of trust or title relating to land, water rights and any other form of property. Existing rural water districts in Minnesota include Lincoln Pipestone, Red Rock, and Rock County water districts.

---

<sup>17</sup> Reference

<sup>18</sup> MN Rules, 2013, Ch. 137, Art. 2, Sec. 9

As currently enacted, this section of Minnesota statutes does not allow for the establishment of water districts in the twin cities metropolitan area (as defined in MS 473.121, Subdivision 2). The legislature would need to modify Minnesota Statutes Section 110A or create new, enabling legislation to create water districts in the Twin Cities metropolitan area.

What is common in all the case studies is a clear driver to pursue alternative water supplies. In Minnesota, a regulatory limit on groundwater availability does not exist. Such a limit would likely come from the MnDNR through the appropriation permitting process, with groundwater limits resulting from resource analysis done as part of the establishment and execution of Groundwater Management Area plans. Another common element of these examples is supply diversification. Where surface water supply has been developed to alleviate issues with the sustainability of groundwater supplies, some amount of groundwater capacity has been maintained to improve or preserve reliability and resiliency in case of supply shortages. The conjunctive use scenarios allow water suppliers to recognize the value invested in previous investments in groundwater supply facilities, even if those supplies shift from primary to secondary sources. In some cases, the continued use of groundwater by any users is made feasible only by the conversion of some supply to surface water supplies. In a regional approach, the investment in alternative surface water supplies can be spread among all users who benefit from the conversion, including groundwater users who can maintain reliance on groundwater sources. This scenario could play out in the Twin Cities metropolitan area if some groundwater users convert to surface water supply, either in response to regulatory limits, or rising costs associated with continued development of groundwater resources.

Allocation of costs among users in a regional framework can promote equity among water users who rely on common resources. In the two examples from Texas, the conversion of some groundwater users to surface water sources allowed continued use of the aquifer by others. Because the users were tied together in a regional framework (like the SJRA), investments in the development of surface water treatment and transmission facilities were recovered through revenues collected from all users. The reliability of the Twin Cities aquifers could be extended by the conversion of some demands to alternative supplies. A regional approach to managing water sources or supplying water, either through cooperative agreements or through the establishment of jurisdictional management areas, would create a framework to allow the allocation of costs among all resource users.

The California example demonstrates a more traditional method of cost allocation, but shows economies that can be recognized using regional or shared-system approaches. In this case, the shared-system approach also introduced the availability of special funding for development of the system. In Minnesota, there are examples of shared systems, including the Joint Powers Board and rural water districts where funds have been made available through State appropriation to support regional approaches to water supply. As supply and resource availability issues continue to emerge in the Twin Cities area, a shared-system approach to supply may provide not only supply reliability and a framework for equitable resource use, but economic efficiencies, as well.