



February 3, 2015

Sarah Beimers  
Minnesota State Historic Preservation Office  
345 Kellogg Blvd. W.  
St. Paul, MN 55102

RE: Southwest Light Rail Transit Project, Hennepin County, Minnesota; consultation on project effects related to the new Kenilworth Lagoon crossing, SHPO #2009-0080

Dear Ms. Beimers,

We are writing to continue our consultation regarding the Southwest Light Rail Transit (LRT) Project (Project). Following standard practice, all Section 106 consulting parties for this Project are copied on this letter.

Thank you for your letter dated December 12, 2014, which provided comments on material submitted on November 12, 2014, and presented at the consulting parties meeting held on November 24, 2014. In addition to the comments provided by your office, several consulting parties provided additional comments on project effects (enclosed).

In your comments, you indicated that the State Historic Preservation Office (SHPO) agreed with the appropriateness of the assessment of potential effects and proposed action steps, but that it would defer concurrence with any preliminary determinations until the Federal Transit Administration (FTA) provided final determinations of effect for review. FTA intends to make final determinations of effect prior to publishing the Supplemental Draft Environmental Impact Statement for the Project. A draft Section 106 agreement will be included in the Final Environmental Impact Statement (FEIS) for the Project and the executed Section 106 agreement will be included as part of the Project Record of Decision.

You also requested clarification from FTA and our office on concerns and expectations for consulting regarding the results of assessment of effect pursuant to 36 CFR 800.5(d). In response, we are providing the following clarification. A number of comments were received in response to the November 2014 consultation. To fully consider comments received before making final determinations of effect, FTA and the Metropolitan Council's (MC) Southwest LRT Project Office (SPO) plan to hold a series of consultation meetings in the coming months (every two to three weeks) with consulting parties to review comments received and consult further on historic properties in the November 12, 2014 consultation materials with a preliminary determination of "to be determined." The purpose of these meetings will be to receive input that FTA will use to 1) make final determinations of effect and 2) resolve adverse effects. This process will include developing measures to avoid, minimize, or mitigate adverse effects, which will be included in a Section 106 agreement for the Project. Per our authority delegated by FTA, the Minnesota Department of Transportation Cultural Resources Unit (MnDOT CRU) will coordinate and facilitate these meetings, while FTA will participate as an active participant. The (MC), the local project sponsor and federal grantee, will also participate in these meetings. Once measures for resolving adverse effects have been identified with consulting parties, as needed, FTA will complete additional consultation to meet the requirements of 36 CFR 800.6.

We have scheduled the next of these consultation meetings with your office and Section 106

consulting parties to provide an opportunity for questions and discussion on this review. All consulting parties have received an invitation to the meeting, and we look forward to the discussion. The meeting will be held on February 6, at 9:30 a.m. at:

Southwest Light Rail Project Office  
6465 Wayzata Boulevard, Suite 500  
St. Louis Park, MN

This meeting will primarily focus on continuing consultation to consider and resolve the Project's adverse effect on the Kenilworth Lagoon. Subsequent meetings will provide an opportunity for FTA to receive input on Project effects on other historic properties and, if needed, to continue consultation to consider Project effects on the Kenilworth Lagoon.

To facilitate the discussion of Project effects on Kenilworth Lagoon, this submittal includes information on the proposed crossing and potential measures to avoid, minimize, or mitigate adverse effects. The information enclosed on the proposed crossing updates the material discussed with your office and all consulting parties during the consultation meeting held on November 24, 2014. Since that time, the Project has revised the bridge design concepts for the new Kenilworth Lagoon crossing that were presented at that meeting in response to input received. In addition, on January 7, 2015 the Minneapolis Park and Recreation Board (MPRB), a Section 106 consulting party, authorized a feasibility and prudence study for a "cut and cover" tunnel and a "jacked box" tunnel as options for the locally preferred alternative (LPA), which is an at-grade crossing over the Kenilworth Lagoon. The materials listed below are included to facilitate this discussion:

- Materials on the Kenilworth Lagoon crossing alternatives:
  - Memo describing three Kenilworth Lagoon crossing options:
    - All modes at-grade over the lagoon
    - "Cut and cover" LRT tunnel under the lagoon
    - "Jacked box" LRT tunnel under the lagoon
  - Table 1. Design details for the three crossing options
  - Table 2. Assessment of effects on the Kenilworth Lagoon for each option
  - Plan sheets of the three crossing options
- Materials on revised bridge design concepts:
  - Table 3. Detailed comparison of Bridge Design Concepts for the new crossing, including concepts presented during the November 24, 2014 consultation meeting and revised design concepts developed in response to comments received
  - Plan sheets of the revised bridge design concepts
  - Renderings of the revised bridge railing concepts

Please provide any comments on the Project effects and design options related to the new Kenilworth Lagoon crossing within 30 days of this letter. We welcome all consulting parties to review the material, participate in the upcoming consultation meeting, and submit any comments within the 30-day review period. If you have any questions or concerns about the enclosed materials, do not hesitate to contact me at (651) 366-4292.

Sincerely,



Greg Mathis  
MnDOT CRU

Enclosures: Comments received in response to the November 12, 2014 consultation materials

- State Historic Preservation Office comments, December 12, 2014
- Minneapolis Park and Recreation Board comments, December 12, 2014
- City of Minneapolis comments December 15, 2014
- Kenwood-Isles Area Association comments December 10, 2014
- Kenwood-Isles Area Association comments November 12, 2014

Table 1. Kenilworth Lagoon/Channel Crossing Options

Table 2. Kenilworth Lagoon/Channel Crossing Options Effects Assessment

Kenilworth Lagoon/Channel Crossing Options *Engineering Plans*

- Option 1: At-Grade LRT Crossing (Council Adopted Scope)
- Option 2: Shallow Cut-and-Cover LRT Tunnel Under Channel
- Option 3: MPRB “Jacked Box” LRT Tunnel (*In Development*)

Table 3. Bridge Design Concepts (2 sheets)

Kenilworth Lagoon Bridge Design Concepts – Comparison

Kenilworth Lagoon/Channel Revised Bridge Design Concepts

- Concept 2A Arched Pier (5 span)
- Concept 2B Steel Pier (5 span)
- Concept 2C Thin Deck (5 span)
- Concept 3 Steel Pier (7 span)

Kenilworth Lagoon/Channel Revised Bridge Design Concepts: Railing Study

cc: Bill Wheeler, Federal Transit Administration  
Maya Sarna, Federal Transit Administration  
Amy Zaref, Federal Transit Administration  
Melissa Jenny, United States Army Corps of Engineers  
Brad Johnson, United States Army Corps of Engineers  
Nani Jacobson, Metropolitan Council  
David Jaeger, Hennepin County  
Regina Rojas, City of Eden Prairie  
Nancy Anderson, City of Hopkins  
Brian Schaffer, City of Minneapolis  
Jack Byers, City of Minneapolis  
Elise Durbin, City of Minnetonka  
Meg McMonigal, City of St. Louis Park  
Jennifer Ringold, Minneapolis Park and Recreation Board  
Bill Walker, Three Rivers Park District  
Craig Westgate, Cedar-Isles-Dean Neighborhood Association  
Kathy Low, Kenwood Isles Area Association  
Tamara Ludt, Preservation Design Works



Consulting Party Comments Received, November 2014 Consultation

*Minnesota State Historic Preservation Office, December 12, 2014*

*City of Minneapolis, December 15, 2014*

*Minneapolis Park & Recreation Board, December 12, 2014*

*Kenwood Isles Area Association, December 10, 2014*

*Kenwood Isles Area Association, November 12, 2014*

STATE HISTORIC PRESERVATION OFFICE

December 12, 2014

Greg Mathis  
MnDOT Cultural Resources Unit  
395 John Ireland Boulevard, Mail Stop 620  
St. Paul, MN 55155-1899

RE: Southwest Light Rail Transit Project  
Multiple Communities, Hennepin County  
SHPO Number: 2009-0080

Dear Mr. Mathis,

Thank you for continuing consultation on the above project which is being reviewed pursuant to the responsibilities given the State Historic Preservation Officer by the National Historic Preservation Act of 1966 and implementing federal regulations at 36 CFR 800, and to the responsibilities given the Minnesota Historical Society by the Minnesota Historic Sites Act and the Minnesota Field Archaeology Act.

We have completed our review of the two (2) project consultation packages which were submitted to our office on 17 October 2014 and 12 November 2014. Our comments are provided below.

In addition to reviewing these materials, we participated in the Section 106 Consulting Parties meeting held at the Southwest Project Office on November 24, 2014. Thank you for convening all of the consulting parties and agency representatives for this meeting.

**Area of Potential Effects Revisions**

As indicated and agreed to in the project's 2010 research design for cultural resources, you have recently completed a reevaluation of the area of potential effect (APE) determinations for this project. The APE reassessment at this time is a result of completion of the 30% Preliminary Plans and several adjustments to the project scope as outlined in the memorandum of understanding (MOU) between the Metropolitan Council and the City of Minneapolis. Although there are previously identified historic properties within the revised APEs, it is our understanding that your agency will continue with identification and evaluation efforts within previously un-surveyed areas and submit these for our review upon completion. At this time, we concur with your determinations for and documentation of the revised APEs as submitted.

You have also provided documentation regarding the establishment of additional parameters for continued analysis of potential adverse effects and adjustments to the APE as project design development continues. We agree with your determination that these additional parameters will provide consistency in the applicability of APE determinations for common project elements.

### **Preliminary Project Effects Assessments**

It is our understanding that the assessments of adverse effect and preliminary determinations of effect provided in your November 12th correspondence have been determined based upon project engineering at the 30% design stage and that adverse effect determinations will be made by the Federal Transit Administration.

We acknowledge that we have previously provided concurrence with what your agency defined, and therefore we perceived, as "assessments of potential effect" which included commonly used Section 106 terminology of "no adverse effect" and "adverse effect". These are now presented in Section 1 of the table entitled *Southwest Light Rail Transit Project: Section 106 Review – Preliminary Determination of Effects on Historic Properties 11/12/2011* (Table) as effect determinations and defined as such in your correspondence. To date, the FTA has not provided final effect determinations for our review and concurrence, therefore these determinations should not be presented as final.

For the historic properties listed under Section 2 and Section 3 of the Table, we agree that the assessment of potential effects and proposed action steps are appropriate at this time. To reiterate, it is our opinion that the preliminary effect determinations provided in this Table serve only to provide a basis for continuing project design development in an effort to avoid or minimize potential adverse effects. We will defer concurrence with any "no adverse effect" or "adverse effect" determinations, preliminary or otherwise, until such time as the FTA provides these determinations to our office for review.

We took the time to review the original correspondence dated May 4, 2010 which, pursuant to 36 CFR 800.2(c)(4), designated your agency to act on behalf of the FTA to complete the following, in consultation with our office, identified consulting parties, and the public:

- Initiate the Section 106 process;
- Identify the area potential effect (APE);
- Conduct appropriate inventories to identify historic properties within the APE;
- Make determinations of eligibility to the National Register of Historic Places;
- Make assessments of potential effect.

The FTA indicated in this letter that they would retain authority to "make determinations of adverse effect" and negotiate the terms and conditions of a Section 106 agreement, if necessary. We respectfully request clarification from the FTA and your agency addressing our concerns and expectations for consultation regarding the results of assessment of adverse effect pursuant to 36 CFR 800.5(d).

Regarding our review of the *Kenilworth Lagoon/Channel Context, History, and Physical Description* report, we agree that this report provides critical information regarding the historic context, physical description, and identification of character-defining features of the Kenilworth Lagoon/Channel property which is a sub-segment of the Chain of Lakes Segment of the National Register-eligible Grand Rounds Historic District. While this report provides identification of the cultural landscape's character-defining features, we recommend that the final version of this report include information regarding identification and evaluation, following National Register criteria, for features in terms of those which may be considered "contributing" or "non-contributing" elements to the eligible historic district. This information will be essential as we continue to consult regarding the assessment of adverse effects and resolution of potential adverse effects.

We look forward to continuing consultation on this project. If you have any questions or concerns regarding this comment letter, please feel free to contact me at 651-259-3456 or [sarah.beimers@mnhs.org](mailto:sarah.beimers@mnhs.org).

Sincerely,

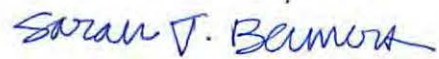
A handwritten signature in blue ink that reads "Sarah J. Beimers". The signature is written in a cursive style with a small dot above the letter 'i' in "Beimers".

Sarah Beimers, Manager  
Government Programs & Compliance

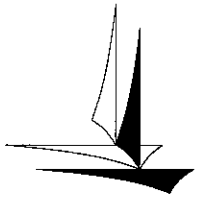

**Minneapolis**  
*City of Lakes*

**Community Planning &  
Economic Development**

105 5<sup>th</sup> Avenue S, Suite 200  
Minneapolis MN 55401

Office 612-673-2597  
Fax 612-673-2728  
TTY 612-673-5154

December 15, 2014

Greg Mathis  
Minnesota Department of Transportation- Cultural Resources Unit  
395 John Ireland Boulevard  
St. Paul, MN 55155

**RE: Southwest Light Rail Transit Project, Hennepin County; Minnesota;  
consultation on potential effects (SHPO#2009-0080)**

Dear Mr. Mathis,

Thank you for providing the materials included in your November 12, 2014 submittal and facilitating the consultation meeting on November 24, 2014 where additional materials about the potential Kenilworth Corridor channel bridge concepts were shared. The City of Minneapolis CPED Long Range Planning Division submits the following comments on behalf the Minneapolis HPC, a consulting party to the Section 106 review.

CPED-Long Range Planning comments on the preliminary determinations of effect are organized in a manner consistent with the organization presented in your November 12, 2014 correspondence and in the table of Preliminary Determination of Effects on Historic Properties.

Section 1 Properties

CPED-Long Range Planning agrees with the analysis of effects, preliminary determinations and associated actions for the Minneapolis properties:

- M&STL RR Bridges over Kenilworth Lagoon
- Burnham Road Bridge
- St. Paul, Minneapolis & Manitoba RR/Great Northern Rwy. Historic District
- Osseo Branch of the St. Paul, Minneapolis & Manitoba RR Historic District
- The Parade
- Site 21HE0436
- Minneapolis Warehouse Historic District

Section 2 Properties

Minikahda Country Club: CPED-Long Range Planning agrees with the effects and the preliminary determination of an adverse effect and action to develop and implement agreement measures. CPED-Long Range Planning agrees with intent to avoid adverse effects through pursuing design alternatives. However, if avoidance of the adverse effects impact results in minimal or no improvements for pedestrian connectivity, CPED-Long Range Planning believes that improving the pedestrian connectivity at this intersection



should be given priority while minimizing and mitigating physical impacts to the Minikahda Club property.

Frieda & Henry J. Neils House: The materials provided as part of the consultation to date do not address any potential effects of vibrations. CPED-Long Range Planning agrees with the other analysis of effects listed in the table, the effects from vibrations should be considered as part of future consultation.

CPED-Long Range Planning agrees with the analysis of effects, preliminary determinations and actions for the following properties identified in Section 2 of the table:

- Lake Calhoun (Grand Rounds)
- Cedar Lake Parkway (Grand Rounds)
- Mahalia & Zacharia Saveland House
- Site 21HE0409
- Kenwood Parkway Residential Historic District
- Kenwood Parkway (Grand Rounds)
- Frank & Julia Shaw House
- Kenwood Park (Grand Rounds)
- Kenwood Water Tower
- Mac Martin House
- Dunwoody Institute

For these properties CPED-Long Range Planning looks forward to future consultation where it is listed as part of the identified actions.

### Section 3 Properties

These properties have effects related to the new Kenilworth Crossing.

- CPED-Long Range Planning agrees with the effects, preliminary determination and action regarding the Kenilworth Lagoon (Grand Rounds). An impact that was discussed in the consultation meeting, but not addressed on the table of effects is vibration. Impacts to feeling, character and experience of the waterway from the effects of vibration is worth consideration.
- We agree with the effects, preliminary determination and action regarding Cedar Lake (Grand Rounds).
- We agree with the effects and actions and look forward to future consultation to determine effects on the following properties:
  - Park Board Bridge #4 (Grand Rounds)
  - Lake of the Isles Parkway (Grand Rounds)
  - Lakes of the Isles (Grand Rounds)
  - Lake of the Isles Residential District

### Potential Kenilworth Corridor Channel Bridge Concepts

CPED-Long Range Planning appreciated the opportunity to briefly review the three bridge concepts developed by Kimley Horn for the project. We look forward to future consultation regarding the design of the bridges to avoid, minimize and/or mitigate adverse effects on the properties identified in Section 3.

Future consultation should not focus purely on choosing one of the three options, but focusing on the underlying assumptions behind their design and how those design assumptions address the effects identified in Section 3 of the table. We do not endorse any of the designs at this time.

Potential Shallow Tunnel Effects

The table of Preliminary Determination of Effects on Historic Properties did not address any additional vibration impacts from the construction of the Shallow Tunnel and associated infrastructure. There are several listed and eligible historic properties in APE in proximity to this infrastructure and the impacts of the shallow tunnels were not considered in prior consultation. Can you provide additional information regarding analysis on potential effects? If there is not additional information available it is worth adding continued consultation regarding these effects to the "Action" for the properties.

Sincerely,



Brian Schaffer

Principal City Planner, AICP  
City of Minneapolis- CPED-Long Range Planning  
105 5<sup>th</sup> Avenue South, Suite 200  
Minneapolis, MN 55415  
Phone: (612) 673-2670  
**[brian.schaffer@minneapolismn.gov](mailto:brian.schaffer@minneapolismn.gov)**

cc: Sarah Beimers, MN SHPO (via email)  
Jack Byers, CPED-Long Range Planning (via email)

This page is intentionally left blank.



**Minneapolis  
Park & Recreation Board**

*Administrative Offices*  
2117 West River Road  
Minneapolis, MN 55411-2227

*Operations Center*  
3800 Bryant Avenue South  
Minneapolis, MN 55409-1000

*Phone*  
612-230-6400

*Fax:*  
612-230-6500

[www.minneapolisparcs.org](http://www.minneapolisparcs.org)

December 12, 2014

Greg Mathis  
MnDOT Cultural Resources Unit  
Office of Environmental Stewardship  
Mail Stop 620  
395 John Ireland Boulevard  
Saint Paul, MN 55155

**Re: Minneapolis Park and Recreation Board Comments on the  
Southwest LRT Section 106 Review**

Dear Greg:

The Minneapolis Park and Recreation Board (MPRB) welcomes this opportunity to comment further on the Section 106 Review for the Southwest Transitway (SWLRT) project. We remain concerned about the archaeological and architecture/historic resources on MPRB land that will be adversely affected by the SWLRT project route and construction plans.

With respect to the adverse effects to the Kenilworth channel of all bridge changes, MPRB staff have the following comments:

- Burnham Road Bridge (HE-MPC-1832) - Although the bridge is a non-contributing feature of the Grand Rounds Historic District, we feel the views from and to it of the SWLRT Project are an important component of the historic nature of the channel, and need to be considered an adverse effect overall.
- Lake Calhoun (HE-MPC-01811) – We continue to be concerned about the traffic and safety impacts of the West Lake Station on this important element of the Grand Rounds, as discussed in our May 16, 2014 comment letter.
- Cedar Lake Parkway (HE-MPC-01833) – We reiterate our comments in our May 16, 2014, comment letter of concern about the ‘quiet zone’ nature of this area and the need to be sure the construction design and documents reflect this unique designation and need.

*President*  
Liz Wielinski

*Vice President*  
Scott Vreeland

*Commissioners*  
Brad Bourn  
John Erwin  
Meg Forney  
Steffanie Musich  
Jon C. Olson  
Anita Tabb  
M. Annie Young

*Superintendent*  
Jayne Miller

*Secretary to the Board*  
Pamela French

- Kenilworth Lagoon (HE-MPC-1822) – The MPRB agrees with the determination of adverse effect of the SWLRT project on the Kenilworth Channel and Lagoon. Noise, dust and views throughout the area will be significantly impacted. We are concerned that no amount of mitigation will offset these adverse effects on the quiet, naturalistic and picturesque nature of the park experience and use.
- Cedar Lake (HE-1820) – We disagree with the preliminary determination of no adverse effect to Cedar Lake at this time. There has not been sufficient study of the sound and visual effects of the proposed project at the Kenilworth Channel nor at the westerly end of the Channel at Cedar Lake to make this conclusion at this time.
- Park Board Bridge #4 (HE-MPC-6901), Lake of the Isles Parkway (HE-MPC-1825), and Lake of the Isles (HE-MPC-1824) – For all three Grand Rounds elements, the preliminary determination remains ‘to be determined.’ All three seem to anticipate the design of the new bridges may avoid, minimize or mitigate any adverse effects. So far, we have seen no evidence that significant mitigation can be achieved.

We recognize that the project office provided potential bridge designs at the consultation meeting on November 24, 2014. Overall, it seems premature for the MPRB to provide comment on designs for the Kenilworth Channel bridges. We would appreciate knowing when the official comment period for these designs is going to begin and end. In the interim, as described above, it appears impossible to mitigate adverse effects based on the features of these designs.

Thank you for this opportunity to comment on the Section 106 review for the LRT. If you have any questions, please do not hesitate to contact Jennifer Ringold, Director of Strategic Planning, at 612-230-6464 or [jringold@minneapolisparcs.org](mailto:jringold@minneapolisparcs.org).

Sincerely,



Jennifer Ringold  
Director of Strategic Planning

# PRESERVATION DESIGN WORKS, LLC

10 December 2014

Greg Mathis  
Minnesota Department of Transportation  
Office of Environmental Services  
Cultural Resources Unit  
Mailstop 620  
395 John Ireland Boulevard  
St. Paul, Minnesota 55155  
greg.mathis@state.mn.us

RE: Kenwood Isles Area Association (KIAA) Comments on November 12, 2014 Consultation on Potential Effects of Southwest Light Rail Transit Project, SHPO #2009-0080

Dear Mr. Mathis,

Thank you for the opportunity to review the materials provided to Sarah Beimers of the Minnesota State Historic Preservation Office and to participate in the 24 November 2014 consultant meeting for the Southwest Light Rail Transit Project. Your warm welcome at the meeting was greatly appreciated. The Kenwood Isles Area Association (KIAA) has the following comments on the materials:

Table of Potential Effects on Historic Properties (12 November 2014):

1. KIAA contends that the language used in the Effects Analysis and Preliminary Determination of Effect is problematic. For example, it is inconsistent to write that access routes to the stations from Kenwood Parkway may "result in potential minor effects from construction of access routes... and from visual effects of access route elements" and then reach a determination of "no adverse effect." The 106 process allows for two possible determinations of effect: no adverse effect and adverse effect (36 CFR 800.5). There are not grades of adverse effects. In accordance with the regulations, KIAA asserts that "minor effects" are adverse effects and, as such, does not agree to a determination of "no adverse effect" on Kenwood's historic resources.
2. KIAA disagrees with the preliminary determination, based on preliminary plans, of no adverse effect on the Kenwood Parkway Residential Historic District (*HE-MPC-18059*), Kenwood Parkway (*HE-MPC-01796*), Kenwood Park (*HE-MPC-01797*), the Frank & Julia Shaw House (*HE-MPC-6603*), the Frieda & Henry J. Neils House (*HE-MPC-6068*), and the Mahalia & Zacharia Saveland House (*HE-MPC-6766*). KIAA agrees that changes in traffic and parking patterns created by the 21<sup>st</sup> Street Station and Penn Station need further assessment. Further, KIAA agrees that the impact of light and noise from the trains on these historic resources also requires further study. Because these potential adverse effects require further assessment, KIAA asserts that it is premature to reach a preliminary

determination of "no adverse effect." If MnDOT, for the FTA, is requesting comment without a memorandum of agreement, additional documentation is required pursuant to 36 CFR 800.11. KIAA looks forward to continued consultation on all issues related to these historic resources, and requests to be a signatory to any memorandum of agreement or programmatic agreement that may be developed for this undertaking in the future.

3. KIAA believes that it is premature to reach a determination of "no adverse effect with continued consultation" because "continued consultation" is not clearly defined. At this time, plans for continued consultation have not been specified, there is not a proposed timetable, and it is not stated whether effects are going to be determined prior to, during, or after construction. While KIAA appreciates that 106 consultation is an ongoing process, it has concerns about the suggestion made during the consultant meeting that "continued consultation" could include traffic monitoring after construction as it is impossible to avoid adverse effects once stations are operational. KIAA asserts that either a memorandum of agreement pursuant to 36 CFR 800.11 or a program agreement pursuant to 36 CFR 800.14 is desirable if effects cannot be determined prior to approval of the undertaking.
4. KIAA is concerned about the impact of construction on Kenwood Parkway, the Kenwood Parkway Residential Historic District, Kenwood Park, the Frank and Julia Shaw House, the Frieda & Henry J. Neils House, and the Mahalia & Zacharia Saveland House. Do the vibration studies account for increased truck and construction equipment traffic and the resulting vibrations and potential impacts on historic resources? If not, KIAA requests preparation of a construction protection plan that incorporates guidance offered by the National Park Service in Preservation Tech Note #3: Protecting a Historic Structure during Adjacent Construction.
5. Assuming that the vibration studies account for the impact of construction and construction-related traffic, KIAA agrees with the finding of "no adverse effect" on the Kenwood Water Tower (*HE-MPC-06475*). If the vibration studies do not account for construction and related equipment, KIAA does not agree with a finding of "no adverse effect" on the Kenwood Water Tower until development of a construction protection plan that incorporates guidance offered by the National Park Service in Preservation Tech Note #3: Protecting a Historic Structure during Adjacent Construction, as well as a memorandum of agreement or a programmatic agreement that specifies how these potential impacts will be monitored following approval of the undertaking.
6. KIAA agrees with the determination of "adverse effect" on the Kenilworth Lagoon. KIAA would like to reiterate the Minneapolis Park and Recreation Board and SHPO concerns, expressed during the November 24, 2014 consultants meeting, regarding the setting and visitor experience of the lagoon. "Setting" and "feeling" are criteria of integrity that are used to determine National Register of Historic Places eligibility and KIAA is concerned that an increase in sound will adversely alter the setting and feeling of the Kenilworth Lagoon and will adversely impact how people use this historic resource. KIAA looks forward to continuing consultation on all issues related to the Kenilworth Lagoon.

Again, thank you for the opportunity to review these materials and to participate in future consultation for the Section 106 review of the Southwest Light Rail Transit Project.

Sincerely,

PRESERVATION DESIGN WORKS

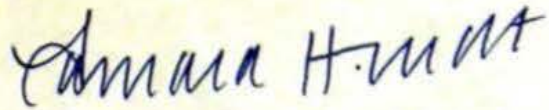

Tamara Halvorsen Ludt  
Architectural Historian  
& Research Associate

cc: Kenwood Isles Area Association  
Cedar Isles Dean Neighborhood Association  
Minneapolis Park and Recreation Board  
Sarah Beimers, Minnesota State Historic Preservation Office



# PRESERVATION DESIGN WORKS, LLC

November 12, 2014

Greg Mathis  
Minnesota Department of Transportation  
Office of Environmental Services-Cultural Resources Unit  
Mailstop 620  
395 John Ireland Boulevard  
St. Paul, Minnesota 55155  
greg.mathis@state.mn.us

CC: Kathy Low, Kenwood Isles Area Association, KIAA, lowmn@comcast.net

RE: Southwest Light Rail Transit Project 2014  
Kenwood Isles Area Association Comments on October 14, 2014 Comments Received in  
Response to April Consultation on Project Effects and October 17, 2014 Adjustments to the  
Area of Potential Effect

Dear Mr. Mathis,

Thank you for the opportunity to review the Section 106 materials provided to Sarah Beimers of the Minnesota State Historic Preservation Office. The October 14, 2014 Comments Received in Response to April 2014 Consultation on Project Effects, SHPO #2009-0080 and the October 17, 2014 Adjustments to the Area of Potential Effect have the potential to have a significant impact on the identified historic resources located within the Kenwood neighborhood.

- KIAA agrees with the May 18, 2014 comments issued by the Minneapolis Park and Recreation Board (MPRB) regarding the size and scale of the proposed new bridge structures crossing the Kenilworth Channel and Lagoon [HE-MPC-1822] and their inconsistency with the historic cultural landscape of the channel, the noise and vibrations caused by the light rail vehicles traveling the bridge, and the fact that it may not be possible to mitigate the impacts of the new bridge. KIAA welcomes the opportunity to continue consultation on the bridge and its impact on the Kenilworth Channel and Lagoon.
- The re-introduced light rail station at 21<sup>st</sup> Street (Station) has the potential to impact the Kenwood Parkway Residential Historic District (District). The station infrastructure and related development has the potential to change traffic and parking patterns in the neighborhood, introduce long-term visual and audible intrusion, and adversely impact the District's historic setting—potential effects that extend beyond the currently proposed APE. KIAA welcomes the opportunity to continue consultation on this station.

- The re-introduced light rail station at 21<sup>st</sup> Street (Station) has the potential to adversely impact Kenwood Parkway/Grand Rounds [HE-MPC-01796]. KIAA welcomes the opportunity to continue consultation on this station.
- KIAA agrees with MNDOT's assertion that the Kenilworth Corridor is located in a park-like setting and believes that the Kenilworth Channel is a significant feature of this setting. The proposed at-grade bridge over the Kenilworth Channel [HE-MPC-1822] has significant potential to adversely impact the historic landscape of the channel. KIAA welcomes the opportunity to continue consultation on this bridge.
- KIAA agrees that lighting and security improvements throughout the corridor in the proximity of station areas will be necessary and welcomes the opportunity to continue consultation on these improvements.
- KIAA welcomes the opportunity to continue consultation on the "high quality aesthetic design, including community engagement, of all fence and railings throughout the corridor."

Again, thank you for the opportunity to review these materials and to participate in future consultation for the Section 106 review of the Southwest Light Rail Transit Project.

Sincerely,  
PRESERVATION DESIGN WORKS



Tamara Halvorsen Ludt  
Research Associate

**Table 1. Kenilworth Lagoon/Channel Crossing Options**

Crossing Options	Option 1: At-Grade LRT Crossing (Council Adopted Scope <sup>1</sup> )	Option 2: Shallow Cut-and-Cover LRT Tunnel Under Channel	Option 3: MPRB “Jacked Box” LRT Tunnel <i>(In Development)</i>
<b>Mode Placement<sup>2</sup></b>			
<i>Trail</i>	At-grade		
<i>LRT</i>	At-grade	Underground	
<i>Freight rail</i>	At-grade		
<b>Existing Bridge Removal Required?</b>	Yes – both trail and freight rail		
<b>New Bridges?</b>	Yes (2) – 1 combined trail/LRT and 1 freight rail	Yes (2) – 1 trail and 1 freight rail	
<i>Trail</i>	Yes – existing trail and freight rail trestles replaced with combined at-grade trail/LRT bridge	Yes – existing trail trestle bridge replaced with at-grade trail bridge	
<i>LRT</i>		No	
<i>Freight rail</i>	Yes – new at-grade bridge west of existing freight rail alignment	Yes – existing freight rail trestle bridge replaced with at-grade freight rail bridge	
<b>Existing Bridges</b>			
<b>Total Width of Existing Trestles (Trail, Freight)</b>	45’		
<b>New Bridges</b>			
<i>Trail Bridge Width</i>	N/A	22.5’	22.5’
<i>Trail/LRT Bridge Width</i>	53.5’	N/A	
<i>Freight rail Bridge Width</i>	20.33’	20.33’	20.33’
<b>Total Width of New Bridges</b>	74’	43’	43’
<b>Open Space Between Bridges</b>	9’	44.5’	44.5’
<b>Total Width of New Bridges + Clear Space Between Bridges</b>	82’	87.5’	87.5’

<sup>1</sup> “Council Adopted Scope” refers to the project scope the Metropolitan Council approved on July 9, 2014.

<sup>2</sup> “At-grade” means generally within a few feet of elevation of the existing freight rail and trail grades. All “at-grade” crossings assumed to maintain at least 14 feet of clearance under the structure to maintain recreational for use of the lagoon/channel.

**Table 2. Kenilworth Lagoon/Channel Crossing Options Effects Assessment**

Crossing Options	Option: At-Grade LRT Crossing (Council Adopted Scope)	Option: Shallow Cut-and-Cover LRT Tunnel Under Channel	Option: MPRB “Jacked Box” LRT Tunnel ( <i>In Development</i> )
<b>Assessment of Effects Summary</b>			
<b>Temporary Effects</b>	Temporary effects include closure of the waterway during project construction as well as noise and vibration generated by construction activities.		
<b>Minimization of Temporary effects</b>	Closing the channel only during construction of the new crossing		
	Staging constructing of the new crossing to minimize the period of time(s) the waterway is closed to recreational use.		
	Providing alternate routes for recreational users of the Kenilworth Lagoon.		
	Coordinate construction hours in accordance with local permits		
<b>Permanent Effects</b>	Develop vibration mitigation plan including measures to minimize impacts from construction		
	As proposed, each option will result in permanent changes to the resource and its setting, including direct physical effects on Kenilworth Lagoon from removal of the existing trestles, and construction of the new, wider crossing will result in alterations to, and/or destruction <sup>1</sup> of distinctive features, spaces, and spatial relationships that characterize the property. Indirect effects from construction and operations include visual and noise.		
	Removal of the existing non-contributing railroad trestles (HE-MPC-1850 and HE-MPC-1851 [non-contributing based on association, not age, design, or integrity]) across the lagoon		
	Design and visibility of the new bridge structure across the lagoon. Depending on the design of the new bridges, the project will introduce new features that may or may not be compatible with the historic design of the Kenilworth Lagoon landscape and setting in terms of size, scale, proportion, massing, and aesthetic character.		
	Replacement of the existing trestles with new light rail/trail and freight rail bridges over Kenilworth Lagoon. Compared to the existing crossing, as proposed:	Replacement of the existing trestles with new trail and freight rail bridges over Kenilworth Lagoon. Compared to the existing crossing, as proposed:	
	<ul style="list-style-type: none"> <li>The width of the new crossing is nearly double that of the existing crossing (82 feet compared to the existing 45 feet). The bridges will also cover an additional 29 feet of the waterway (74 feet compared the existing 45 feet) that will alter the features, spaces and spatial relationships of the middle section of Kenilworth Lagoon.</li> <li>Collectively, these aspects of the new crossing will alter the experience of the historic uses of the waterway, thereby resulting in an adverse effect on the property’s integrity of feeling.</li> </ul>	<ul style="list-style-type: none"> <li>The new crossing will be substantially wider than the existing crossing (87.5 feet compared to the existing 45 feet). However, the combined width of the proposed new bridges is slightly narrower than the existing trestles (43 feet compared 45 feet).</li> <li>The new bridges are also spaced 44.5 feet apart, which is greater than the At-Grade LRT Crossing option, minimizing the effect on the integrity of feeling of the waterway.</li> </ul>	
The width of the new crossing, which is nearly double the width of the existing crossing, will extend 37 feet into the middle section of the Kenilworth Lagoon. Accordingly, it will have an adverse effect on the character and feeling of this space, including its distinctive features, spaces, and spatial relationship. It will also have an effect on the experience of using the waterway when passing under the new structures.	Impact of the width of the new crossing on the character and feeling of the middle section of the Kenilworth Lagoon and on the experience of using the waterway when passing under the new structures. The new crossing, which is nearly double the width of the existing crossing, will extend 42.5 feet into this space.		
Possible destruction <sup>1</sup> or alteration of portions of the contributing WPA Rustic style retaining walls. Depending on the design of new bridges over the Kenilworth Lagoon, this option may or may not result in an adverse direct physical effect to the WPA Rustic style retaining walls.	This option results in the loss of the greatest amount of historic materials and workmanship. It is also the only option that cannot avoid destruction <sup>1</sup> above of portions to the WPA Rustic style retaining walls. It therefore has the greatest adverse effect on the integrity of materials and workmanship of Kenilworth Lagoon.	This option may require possible destruction <sup>1</sup> or alteration of portions of the contributing WPA Rustic style retaining walls. Depending on the design of new bridges over the Kenilworth Lagoon, this option may or may not result in an adverse direct physical effect to the WPA Rustic style retaining walls.	
Alterations to portions of the topography, including the lagoon banks.	Removal of portions of the topography resulting from the excavation of	Alterations to portions of the topography, including the lagoon banks.	

<sup>1</sup> The term “destruction” is a term used in applying the *Secretary of Interior’s Standards for the Treatment of Historic Properties (36 CFR 68)*

Crossing Options	Option: At-Grade LRT Crossing (Council Adopted Scope)	Option: Shallow Cut-and-Cover LRT Tunnel Under Channel	Option: MPRB "Jacked Box" LRT Tunnel ( <i>In Development</i> )
		<p>a trench across the Kenilworth Lagoon to construct the tunnel. This option requires excavation of a trench across the entire width of Kenilworth Lagoon for construction. As a result, construction of the new crossing will have an adverse effect on the integrity of design, materials, workmanship, setting, and feeling of Kenilworth Lagoon.</p>	<p>This alternative has less of a direct physical effect on Kenilworth Lagoon than the Shallow Cut-and-Cover LRT Tunnel option since it does not require excavation of a large trench across Kenilworth Lagoon. While this alternative requires the excavations of large pits at each end of the crossing to construct the tunnel, only a small portion of the pit on the north end would be within the boundaries of the Kenilworth Lagoon, but it would be within the historic railroad corridor, so it will not alter any contributing fabric of the lagoon property. However, permanent soil stabilization within the lagoon is needed for the jacked box construction under the lagoon.</p>
	Removal and/or replacement of some existing vegetation.		
	<p>Introduces operations noise from LRT that will alter the experience of the historic uses of the waterway that is avoided by the Shallow Cut-and-Cover LRT Tunnel and "Jacked Box" LRT.</p>	<p>Avoids potential effects of LRT operations noise on Kenilworth Lagoon since LRT would cross this property underground</p>	<p>Avoids potential effects of LRT operations noise on Kenilworth Lagoon since LRT would cross this property underground</p>
	<p>The sloping alignment of the new LRT crossing, which is on a 2% grade, will introduce a new addition that is different than existing structures over the canal system that link the Chain of Lakes, which in elevation appear to have relatively flat or slightly arched alignments over the water. Accordingly, this crossing is inconsistent with historic features and characteristics of the canal system that connects the Chain of Lakes, thereby resulting in an adverse effect on the property's integrity of design and feeling, which is avoided by the Shallow Cut-and-Cover LRT Tunnel and "Jacked Box" LRT Tunnel options.</p>	<p>Since the LRT crossing will be located underground in this alternative, it avoids the introduction of a sloping bridge to the canal system that links the Chain of Lakes that is required by the At-Grade Crossing option.</p>	<p>Since the LRT crossing will be located underground in this alternative, it avoids the introduction of a sloping bridge to the canal system that links the Chain of Lakes that is required by required by the At-Grade Crossing option.</p>
<b>Measures for Minimizing and Mitigating Permanent Direct Effects for All Crossing Options</b>	Develop a Section 106 Agreement including all measures to avoid, minimize or mitigate adverse effects on historic properties		
	Designing the new crossing in accordance with the <i>Secretary of Interior's Standards for the Treatment of Historic Properties</i>		
	Develop the design for the new crossing in consultation with MnSHPO and other consulting parties. Consultation will occur throughout the design process so that historic values are integrated into the design process and incorporated into the implemented design		
	Develop a plan to monitor impacts to historic properties during construction		



## **Kenilworth Lagoon/Channel Crossing Options Engineering Plans**

- Option 1: At-Grade LRT Crossing (Council Adopted Scope)
- Option 2: Shallow Cut-and-Cover LRT Tunnel Under Channel
- Option 3: MPRB “Jacked Box” LRT Tunnel (*In Development*)



## **Kenilworth Lagoon/Channel Crossing Options** *Engineering Plans*

Option 1: At-Grade LRT Crossing (Council Adopted Scope)

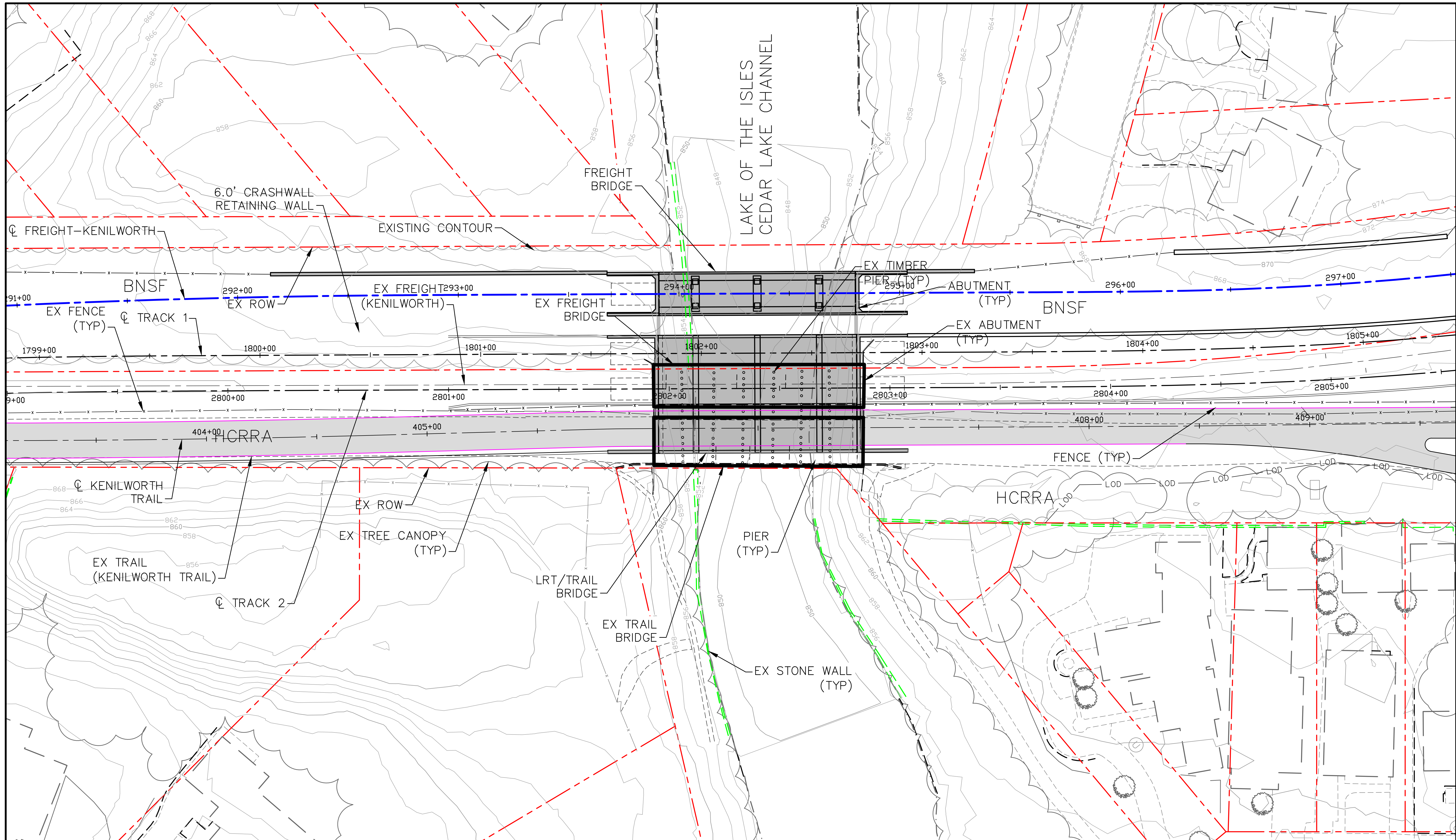

**PROPOSED LAKE OF THE ISLES  
CEDAR LAKE CHANNEL BRIDGE**

IRT #18  
Rev 3  
11/2014

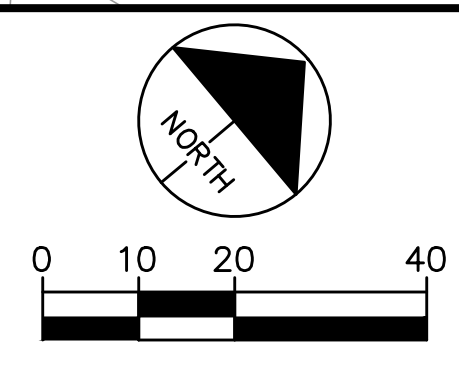

DATE: 11/10/14 BY: J. B. WOODS TO: J. B. WOODS FROM: J. B. WOODS



Apr. 29 2014 09:08 am V:\3300\_PFC-E\CAD\SEGMENT EXHIBITS\CIVIL\ES-CO LOCATION\_TYPICALS.dwg By: BlunderCC

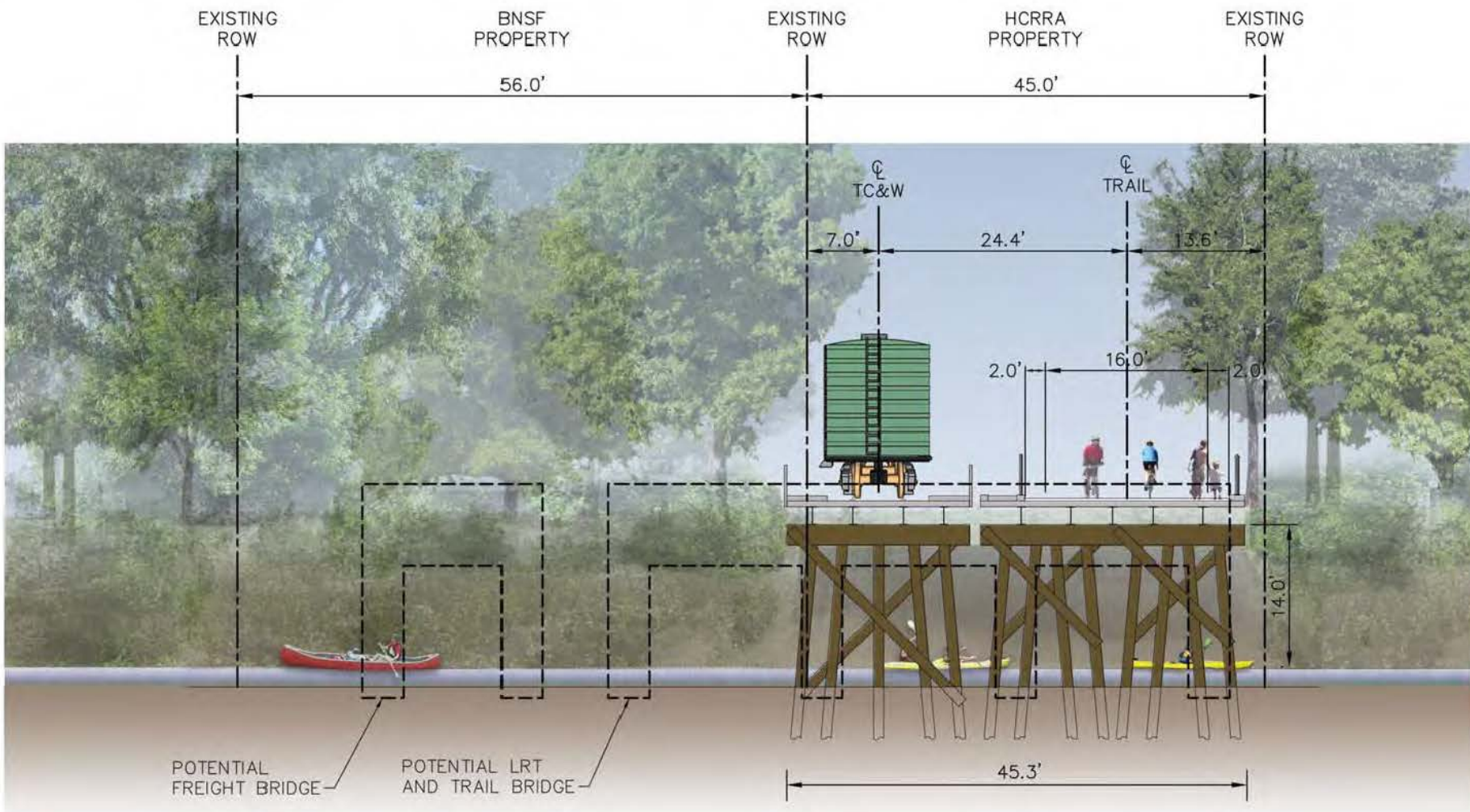

**DRAFT-WORK IN PROCESS**



**SOUTHWEST LIGHT RAIL**  
EXISTING CEDAR ISLES CHANNEL  
CO-LOCATION

IRT #18  
Rev 1  
11/2014

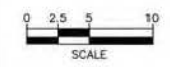

**Kimley»Horn**

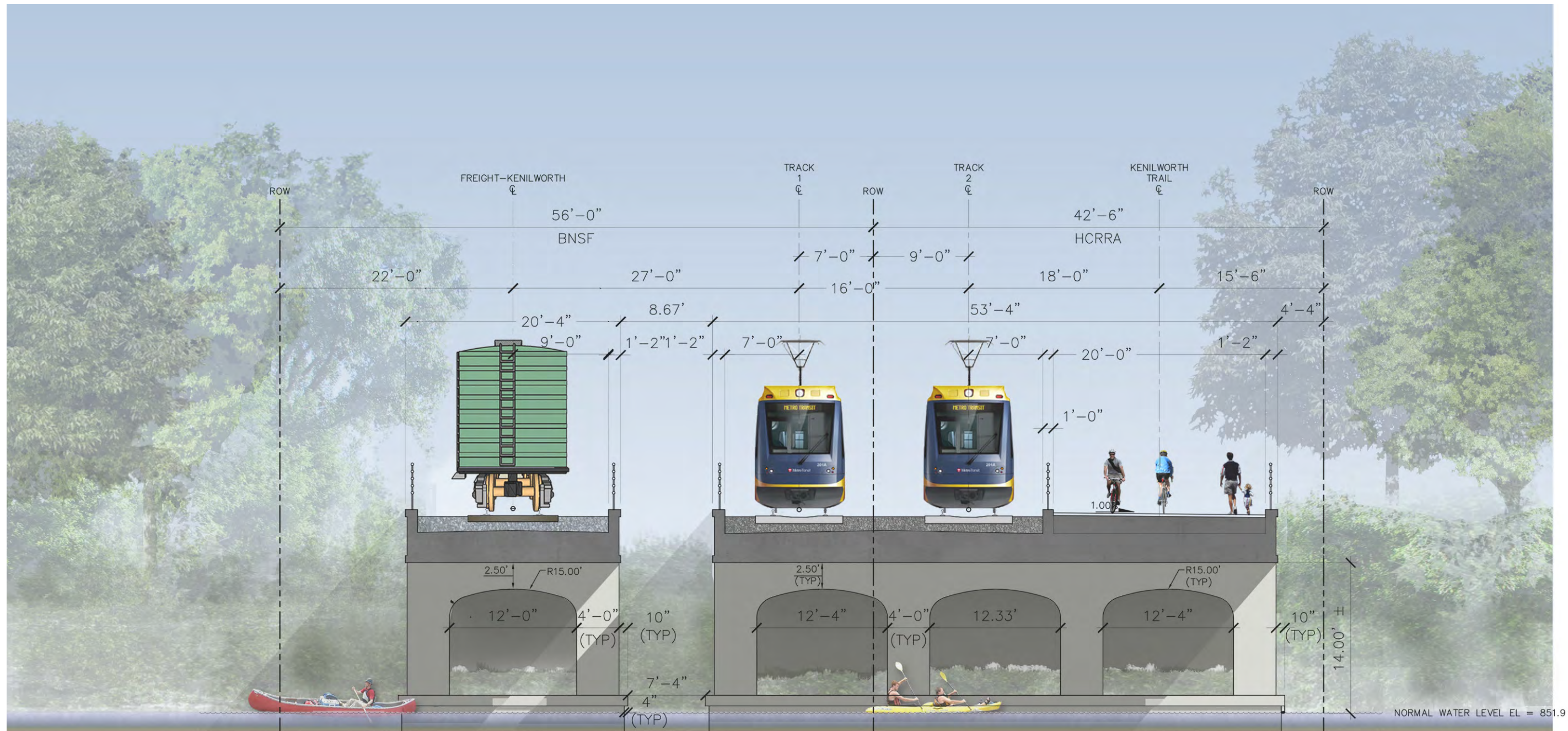

**DRAFT - WORK IN PROCESS**



**KENILWORTH CORRIDOR**  
CHANNEL BRIDGE CONCEPTS - ARCHED PIER SECTION

NOVEMBER 2014





## **Kenilworth Lagoon/Channel Crossing Options** *Engineering Plans*

Option 2: Shallow Cut-and-Cover LRT Tunnel Under Channel

Feb, 02 2015 11:29 am V:\3300\_PEC-E\CAD\SEGMENT E3\LAYOUTS\CIVIL\E3-TUNNEL-SHORT-VERSION PRE 2014-03-19.dwg By: BunderCC

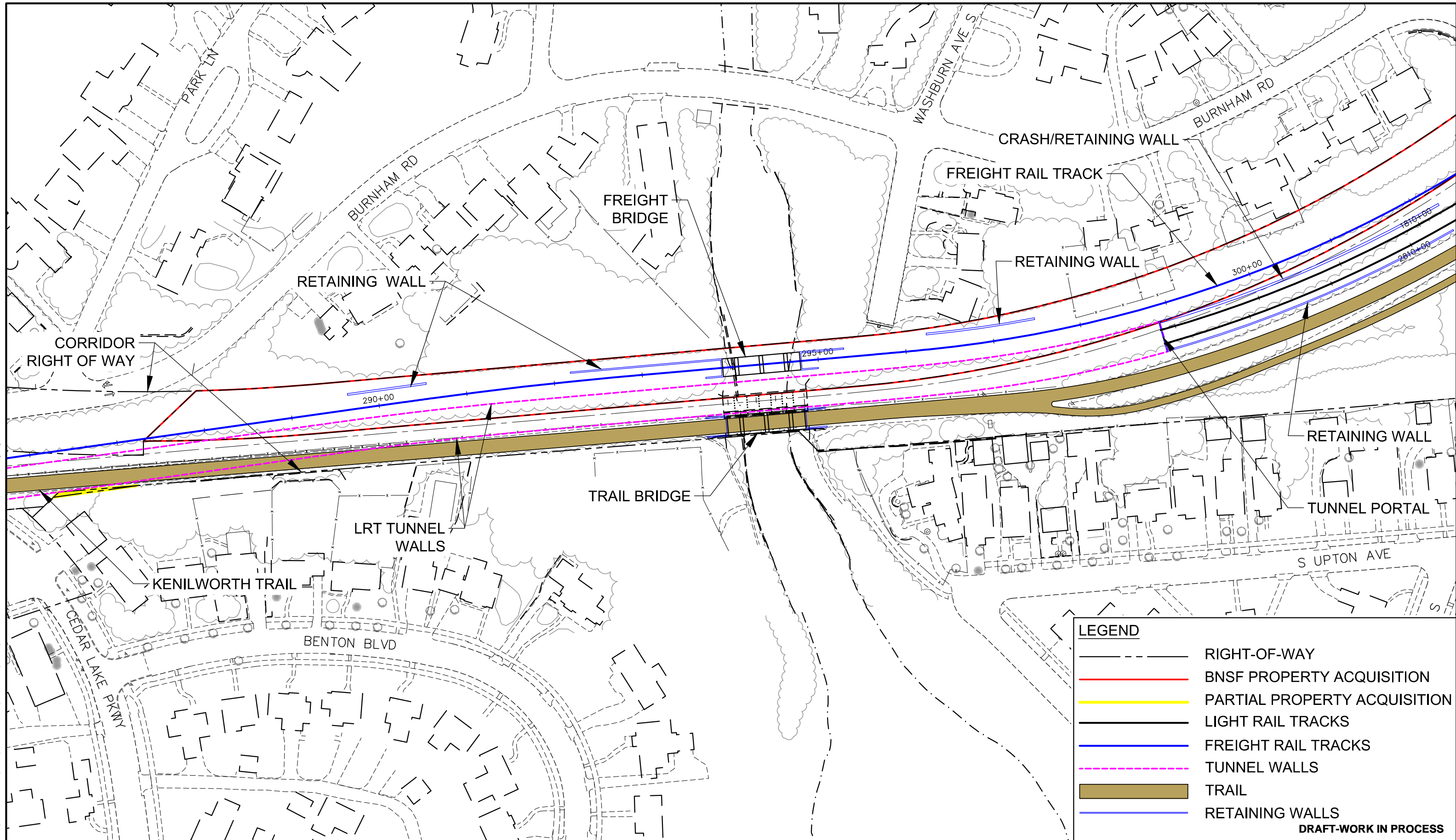

LEGEND	
	RIGHT-OF-WAY
	BNSF PROPERTY ACQUISITION
	PARTIAL PROPERTY ACQUISITION
	LIGHT RAIL TRACKS
	FREIGHT RAIL TRACKS
	TUNNEL WALLS
	TRAIL
	RETAINING WALLS
<b>DRAFT-WORK IN PROCESS</b>	



**SOUTHWEST LIGHT RAIL**  
SHALLOW CUT-AND-COVER LRT TUNNEL UNDER CHANNEL

REV 0  
02/02/2015

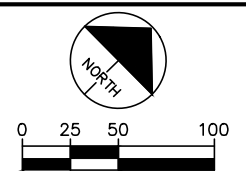

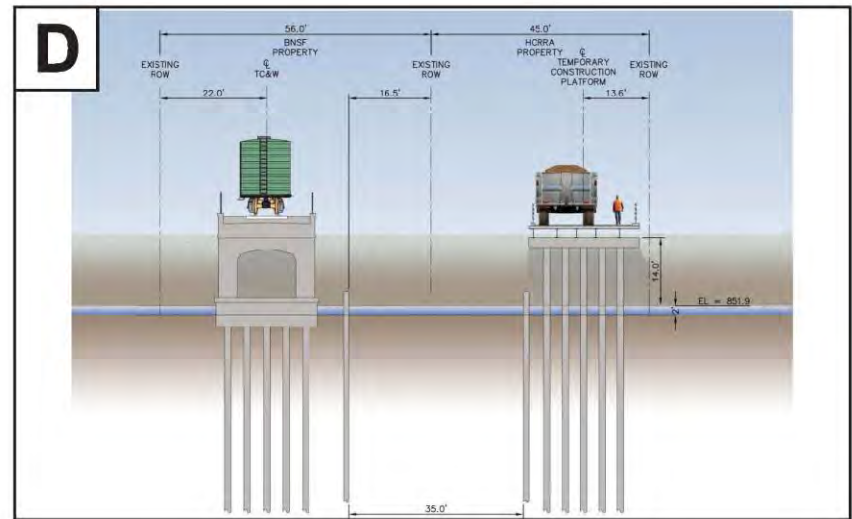
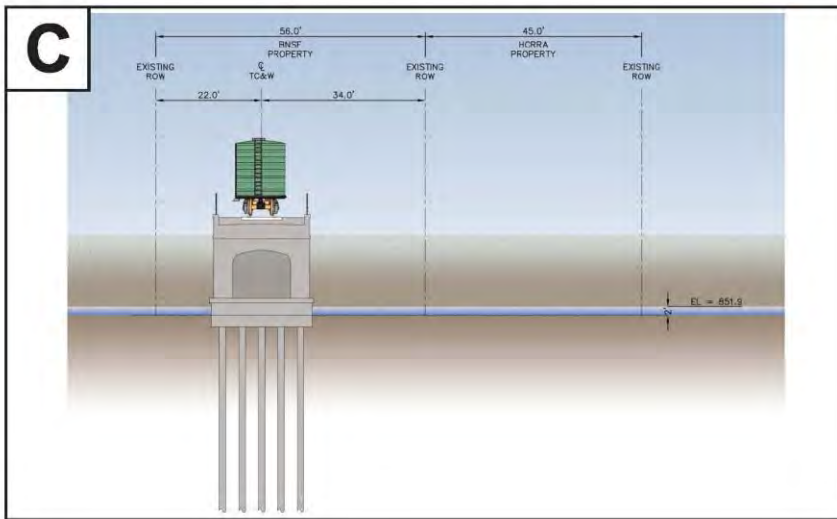
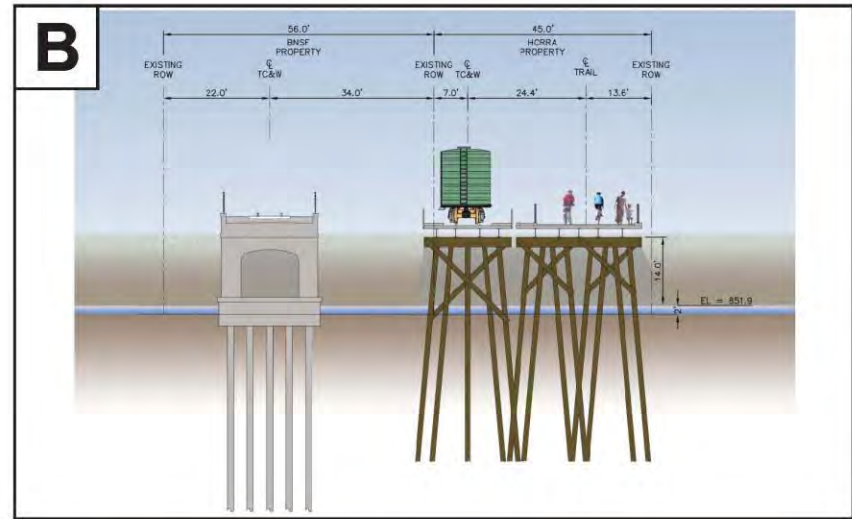
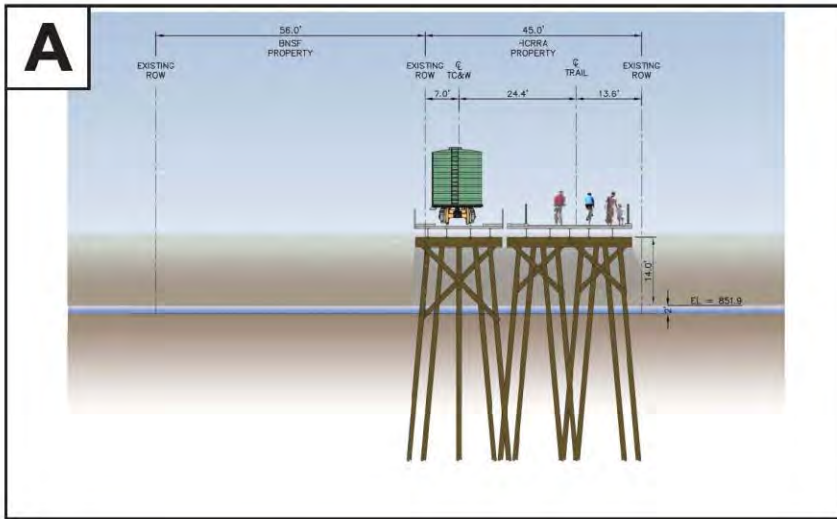

**DRAFT – WORK IN PROCESS**



Southwest LRT  
Shallow Cut-and-Cover Tunnel Typical Construction Sequence



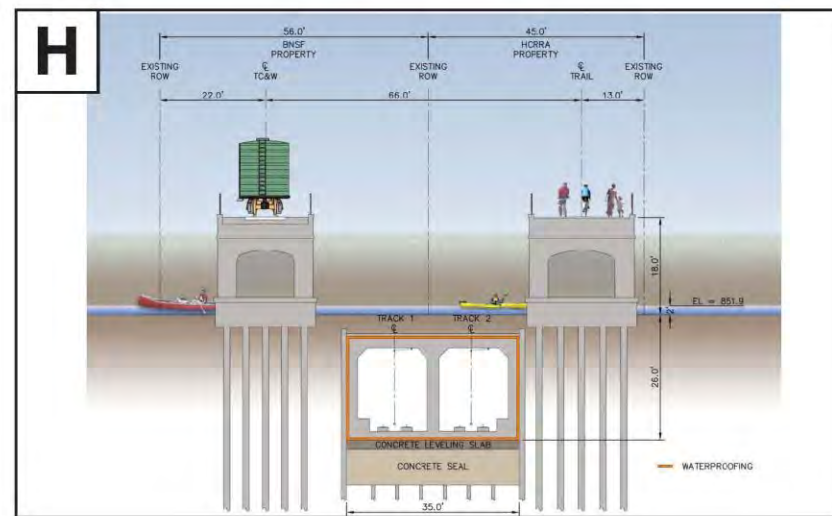
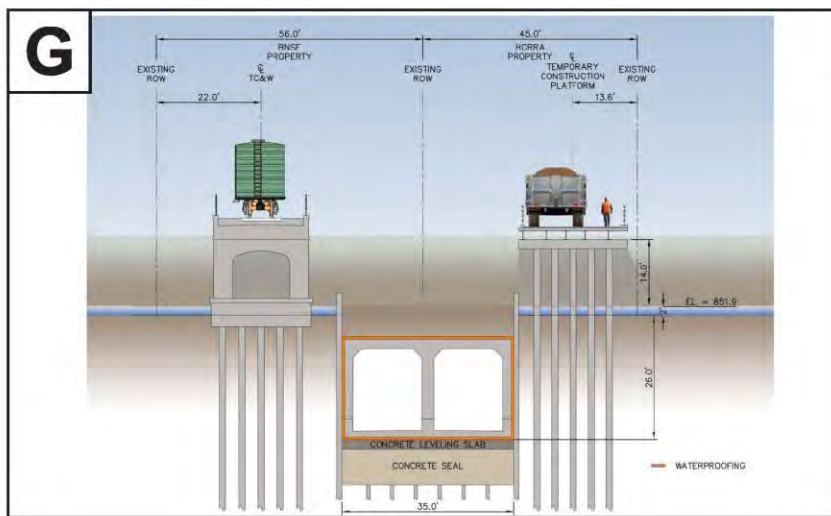
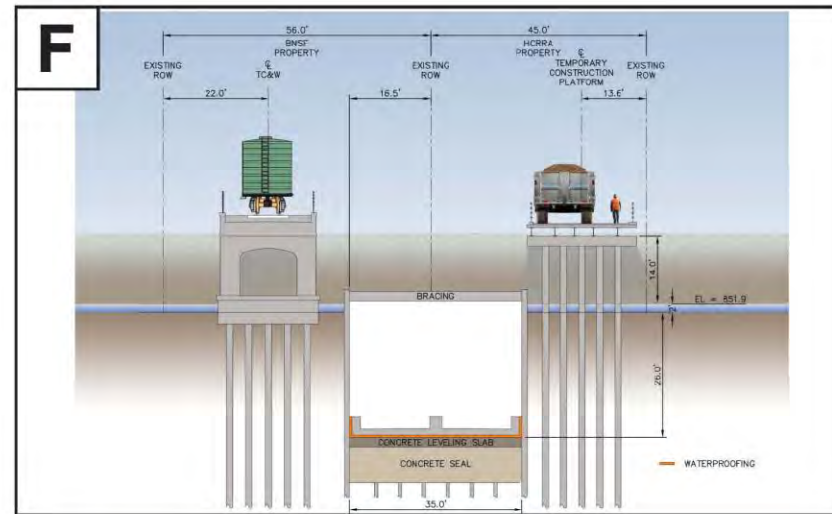
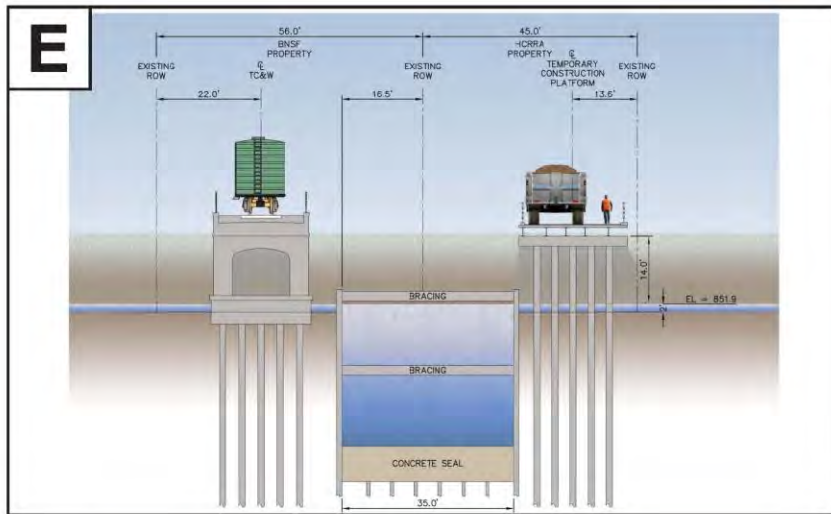

**DRAFT – WORK IN PROCESS**



## **Kenilworth Lagoon/Channel Crossing Options** *Engineering Plans*

Option 3: MPRB “Jacked Box” LRT Tunnel (*In Development*)

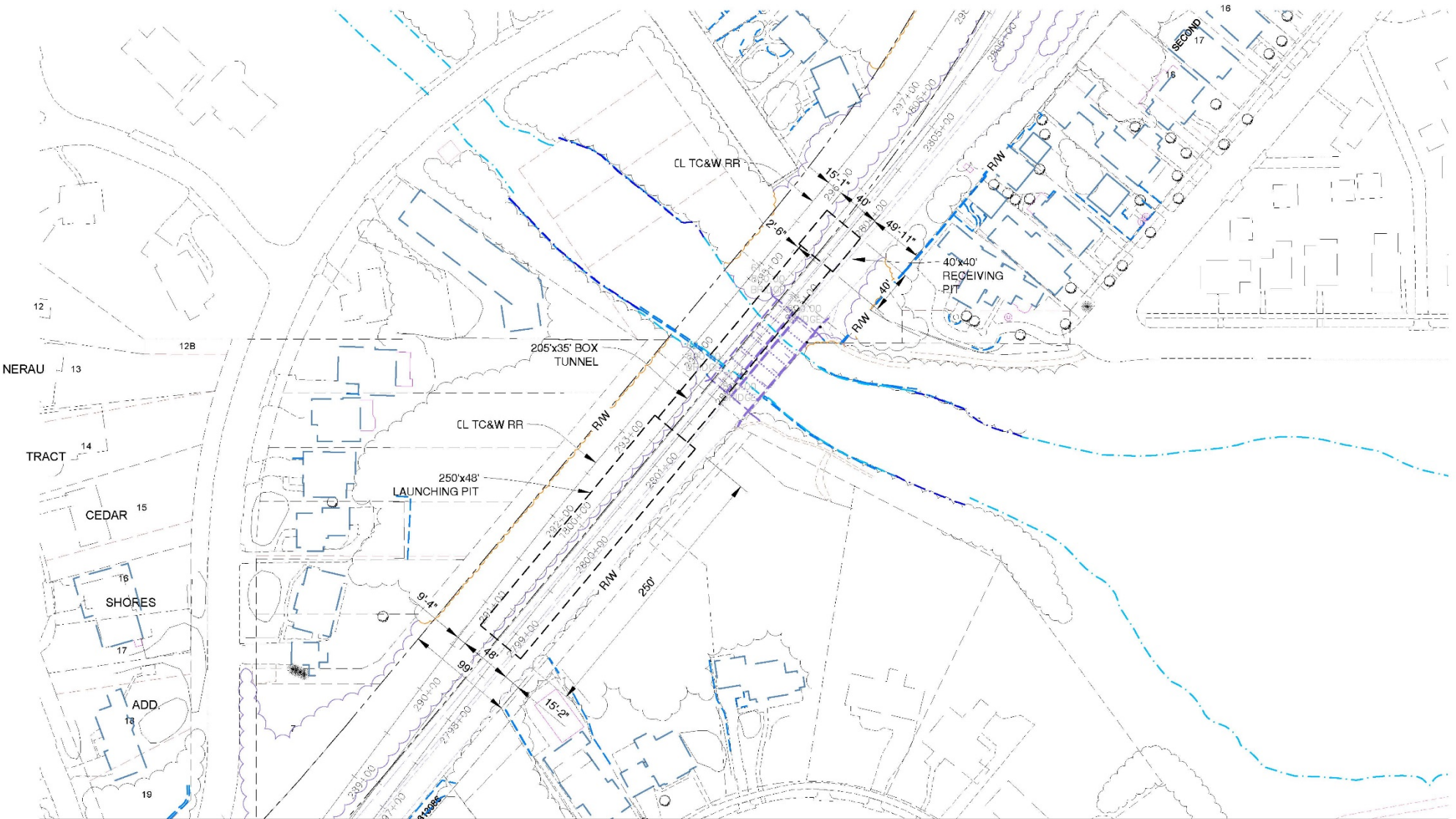

NO	DATE	REVISION / ISSUED / REVISED	DESIGN	DRAWN	CHK
1	7/29/25	PRELIMINARY	XX	XX	XX

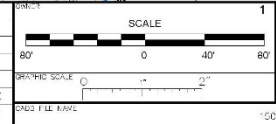

PROJECT NO. 150130 PLAN VIEW.DWG

PROJECT	KENILWORTH CROSSING	SHEET	P-1
SHEET TITLE	PROJECT OVERVIEW		
PROJECT LOCATION	MINNEAPOLIS, MN	PROJECT NO.	150130-000
		DRAWING NO.	1 OF 1



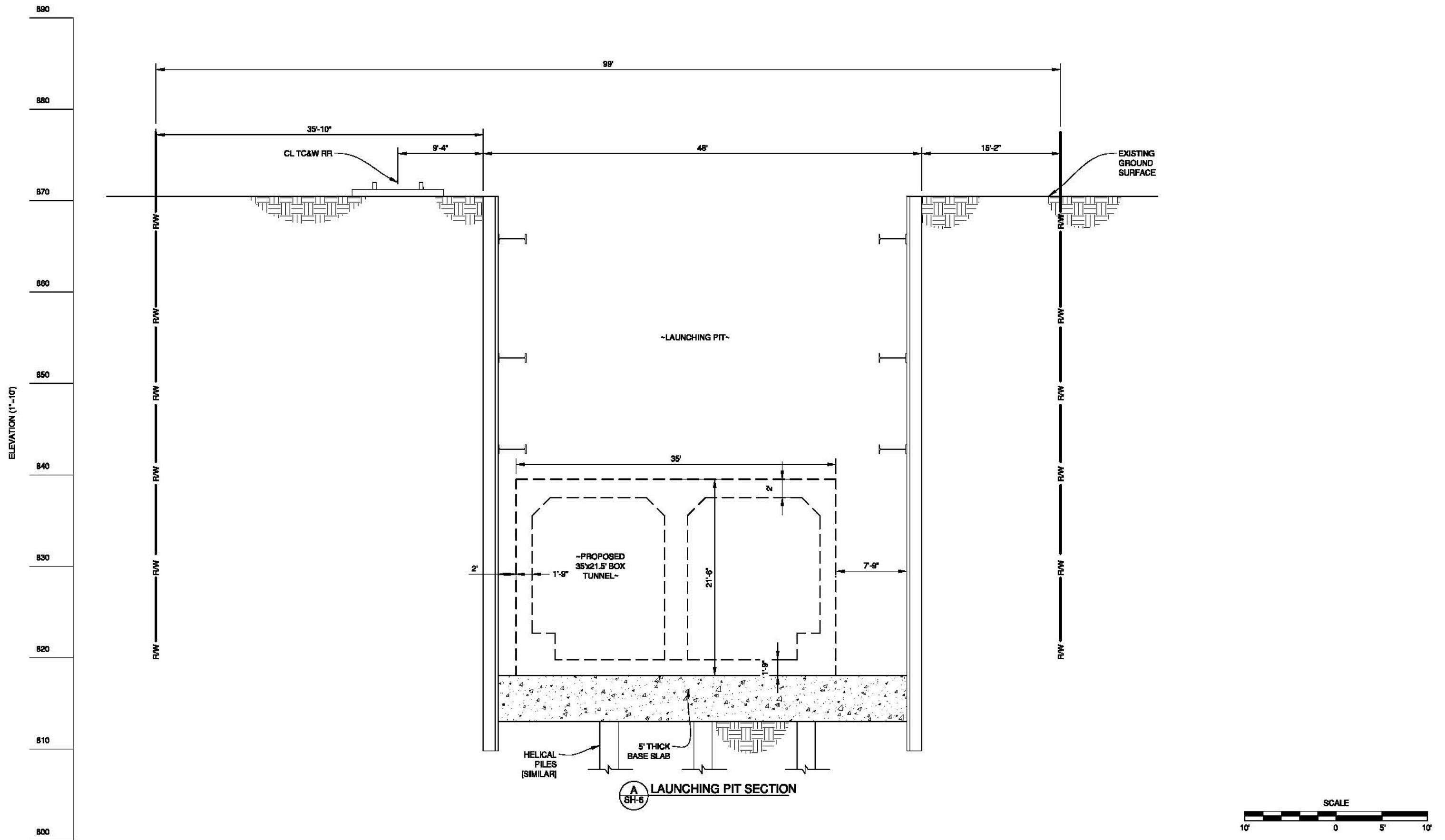

**A**  
SH-6  
LAUNCHING PIT SECTION

NO.	DATE	REASON ISSUED/REVISED	DESIGN	DRAWN	CK
1	1/30/15	PRELIMINARY	GP	KB	TC

OWNER	CLIENT
MINNEAPOLIS PARK & RECREATION BOARD	
GRAPHIC SCALE	0 5 10'
CADD FILE NAME	150130 PROFILES.DWG



PROJECT	KENILWORTH CROSSING	SHEET	SH-6
SHEET TITLE	LAUNCHING PIT SECTION		
PROJECT LOCATION	MINNEAPOLIS, MN	PROJECT NO.	414044-000
		DRAWING NO.	6 OF 7

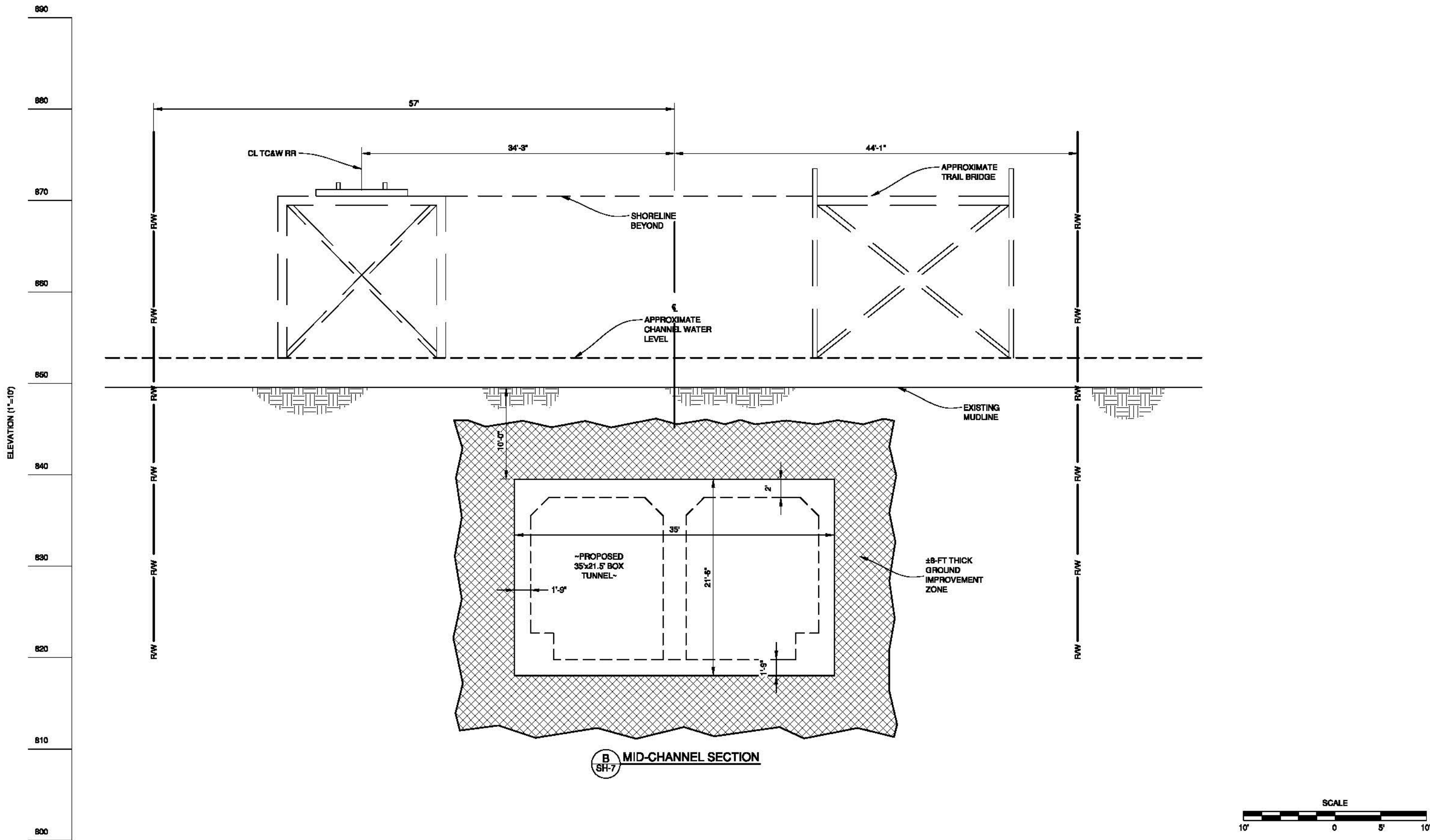

**B** MID-CHANNEL SECTION  
SH-7

NO.	DATE	REASON ISSUED/REVISED	DESIGN	DRAWN	CK
1	1/30/15	PRELIMINARY	GP	KB	TC

OWNER	CLIENT
MINNEAPOLIS PARK & RECREATION BOARD	
GRAPHIC SCALE	0 1/2" 1"
CADD FILE NAME	150130 PROFILES.DWG



PROJECT	KENILWORTH CROSSING	SHEET	SH-7
SHEET TITLE	MID-CHANNEL SECTION		
PROJECT LOCATION	MINNEAPOLIS, MN	PROJECT NO.	414044-000
		DRAWING NO.	7 OF 7

**Table 3: Bridge Design Concepts**

Bridge Concept	Existing Trail/ Freight Bridge: Timber Pile (7 span)	Concepts Presented in November 2014			Revised Concepts				
		Concept 1A: Arched Pier (4 span)	Concept 1B: Steel Pier (4 span)	Concept 1C: Thin Deck (4 span)	Concept 2A: Arched Pier (5 span)	Concept 2B: Steel Pier (5 span)	Concept 2C: Thin Deck (5 span)	Concept 3*: Steel Pier (7 span)	
Total No. of Piers	6	3			4				6
No. of Piers at water level	4	3			2				4
Individual Span Length (Centerline to Centerline)	Varies 12'-9" to 13'-11"	14' & 29'	14' & 29'	23' & 25'	25'				14'
Clearance Between Piers	+/-11'-5"	12' & 25'	13'-3" & 27'-6" (LRT), 12'-6" & 26'-0" (FRT)	21'-9" & 22'-6" (LRT), 20'-10" & 20'-8" (FRT)	21'	23'-6" (LRT), 21'-6" (FRT)	22'-6" (LRT), 20'-8" (FRT)	12'-6"	
Pier Width	Single Row 14"-16" Dia.	4'	Single Row 18" Dia. (LRT), Double Row 18" Dia. (FRT)	2'-6" (LRT), 4'-4" (FRT)	4'	Single Row 18" Dia. (LRT), Double Row 18" Dia. (FRT)	2'-6" (LRT), 4'-4" (FRT)	18" Dia.	
Bridge Length (Abutment-to-Abutment)	96'	86'	86'	96'	107'	125'	125'	100'	
Pier Cap (Width x Depth)	14" SQ.	4'-0" x 2'-6"	3'-6" x 3'-0" (LRT), 4'-0" x 3'-0" (FRT)	N/A (LRT), 4'-4" x 3'-0" (FRT)	4'-0" x 2'-6"	3'-0" x 3'-0" (LRT), 4'-0" x 3'-0" (FRT)	N/A (LRT), 4'-4" x 3'-0" (FRT)	3'-0" x 2'-8"	
Total Bridge Thickness without Railing (Parapet+Deck+Beams)	+/- 5'	4'-0"	3'-2"	1'-8"	4'-0"	3'-10"	1'-8"	3'-4"	

\*7 span options for the arched pier and thin deck concepts were also considered, but are not depicted in this table due to the lack of clearance between piers.

# Southwest Light Rail Transit Project, Kenilworth Lagoon Bridge Design Concepts – Comparison<sup>1</sup>

02/02/2015

## Concept 1A: Arched Pier (4 span)

### A. Engineering & Constructability

1. Pier centered in channel.
2. Bridge centered on channel resulting in pier overlap with channel bank limits.
3. Pier layout does not provide a span over channel bank limits.
4. Individual span lengths vary from 14' to 29'.

## Concept 1B: Steel Pier (4 span)

### A. Engineering & Constructability

1. Pier centered in channel.
2. Bridge centered on channel resulting in pier overlap with channel bank limits.
3. Pier layout does not provide a span over channel bank limits.
4. Individual span length vary from 14' to 29'.
5. Double row of piles for freight piers.

## Concept 1C: Thin Deck (4 span)

### A. Engineering & Constructability

1. Pier centered in channel.
2. Bridge centered on channel resulting in pier overlap with channel bank limits.
3. Pier layout does not provide a span over channel bank limits.
4. Individual span length vary from 23' to 25'.

## Concept 2A: Arched Pier (5 span)

### A. Engineering & Constructability

1. Due to the natural meandering of channel, the freight pier 4 will overlap with the channel bank limits.
2. Overall bridge length increase of 11', compared to existing.

## Concept 2B: Steel Pier (5 span)

### A. Engineering & Constructability

1. Due to the natural meandering of channel, the freight pier 4 will overlap with the channel bank limits.
2. Overall bridge length increase of 29', compared to existing.
3. Double row of piles for freight piers.

---

<sup>1</sup> This memo only includes issues related to engineering and constructability of different bridge types. It does not identify or include effects issues under Section 106 since effects of each bridge concept would vary depending on the crossing option selected (At-Grade LRT Crossing, Shallow-Cut-and-Cover LRT Tunnel, "Jacked Box" LRT tunnel)

**Concept 2C: Thin Deck (5 span)**

**A. Engineering & Constructability**

1. Due to the natural meandering of channel, the freight pier 4 will overlap with the channel bank limits.
2. Overall bridge length increase of 29', compared to the existing bridge.

**Concept 3: Steel Pier (7 span)**

**A. Engineering & Constructability**

1. Proposed LRT/Trail piers 5 & 6 and north abutment will be constructed on top of existing timber piles.
2. Due to the natural meandering of channel, the freight pier 6 will overlap with the channel bank limits.
3. Single row of piles for freight bridge versus double row of piles for 4 and 5 span bridges.



## **Kenilworth Lagoon/Channel Revised Bridge Design Concepts**

*Revised bridge design concepts based upon consulting party comments*

Concept 2A Arched Pier (5 span)

Concept 2B Steel Pier (5 span)

Concept 2C Thin Deck (5 span)

Concept 3 Steel Pier (7 span)

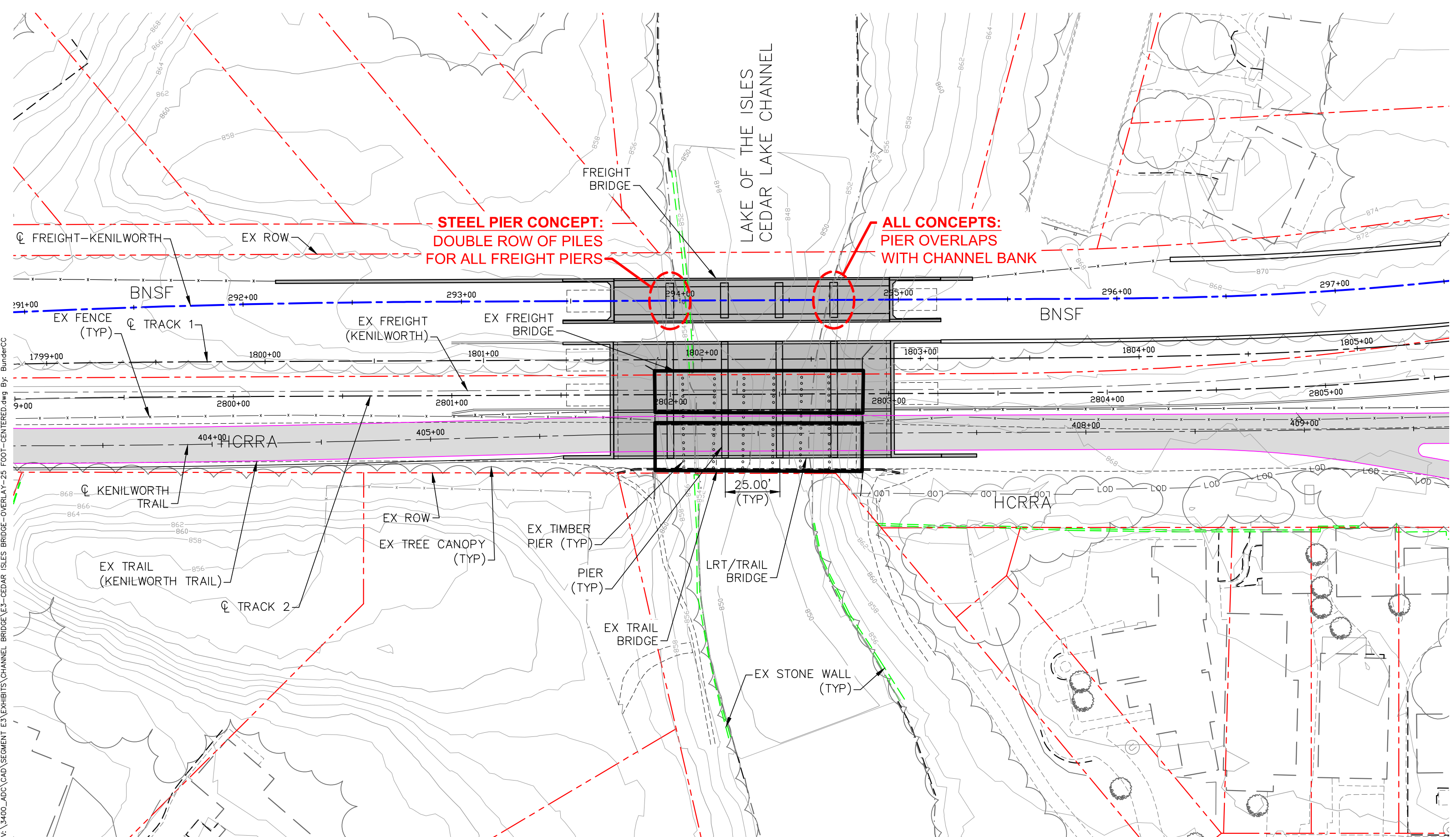

Feb, 02 2015 07:54 am V:\3400\_ADC\CAD\SEGMENT E3\EXHIBITS\CHANNEL BRIDGE E3-CEDAR ISLES BRIDGE-OVERLAY-25 FOOT-CENTERED.dwg By: BunderCC

**SOUTHWEST LIGHT RAIL**  
 CEDAR LAKE CHANNEL BRIDGE - STEEL PIER, ARCHED PIER AND THIN DECK  
 5 SPAN (2 PIERS WITHIN CHANNEL)

Rev 0  
 02/02/2015

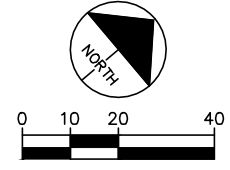

# ARCHED PIER CONCEPT

DRAFT-WORK IN PROCESS

Feb, 02 2015 08:00 am V:\3400\_ADC\CAD\SEGMENT E3\EXHIBITS\CHANNEL BRIDGE\PAGE BREAKS.dwg By: BunderCC



**SOUTHWEST LIGHT RAIL**  
CEDAR LAKE CHANNEL BRIDGE - ARCHED PIER  
5 SPAN (2 PIERS WITHIN CHANNEL)

Rev 0  
02/02/2015



**Kimley»Horn**



Feb, 02 2015 10:52 am V:\3400\_ADC\CAD\SEGMENT E3\EXHIBITS\CHANNEL BRIDGE\E3-CIV-ARCHED-PIER-5-SPAN-ELEV.dwg By: BunderCC

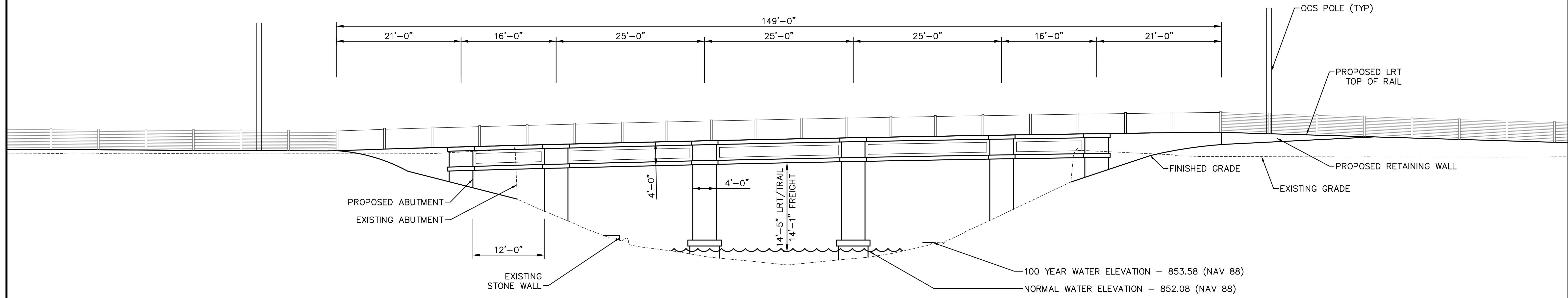

DRAFT-WORK IN PROCESS



**SOUTHWEST LIGHT RAIL**  
 CEDAR LAKE CHANNEL BRIDGE - ARCHED PIER  
 5 SPAN (2 PIERS WITHIN CHANNEL)  
 TRAIL BRIDGE VIEW

Rev 0  
 02/02/2015

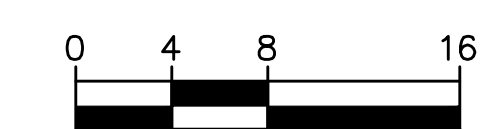

Feb, 02 2015 10:56 am V:\3400\_ADC\CAD\SEGMENT E3\EXHIBITS\CHANNEL BRIDGE\E3-CIV-FREIGHT-ARCHED-PIER-5-SPAN-ELEV.dwg By: BunderCC

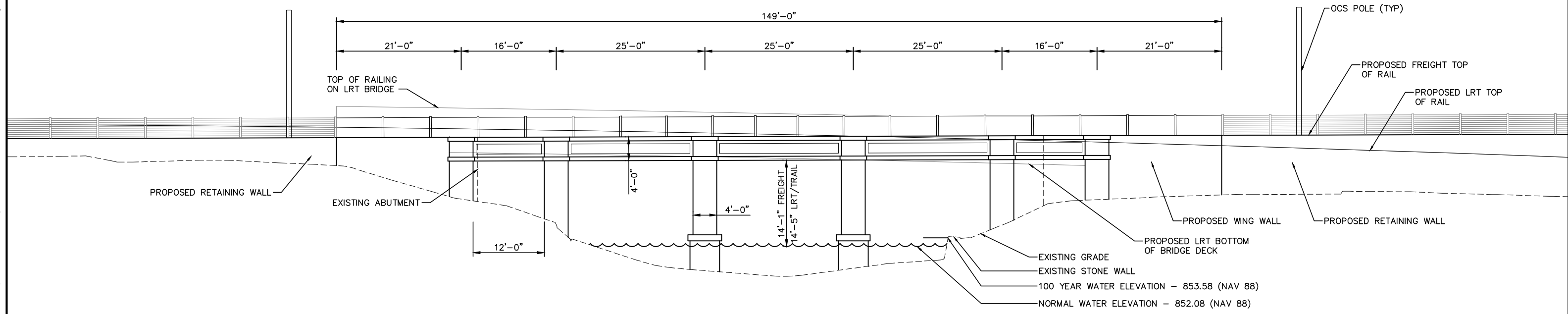

DRAFT-WORK IN PROCESS



**SOUTHWEST LIGHT RAIL**  
 CEDAR LAKE CHANNEL BRIDGE - ARCHED PIER  
 5 SPAN (2 PIERS WITHIN CHANNEL)  
 FREIGHT BRIDGE VIEW

Rev 0  
 02/02/2015

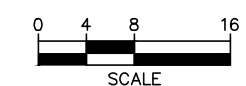

Feb, 02 2015 09:13 am V:\3400\_ADC\CAD\SEGMENT E3\EXHIBITS\CHANNEL BRIDGE\E3-CIV-ARCHED-PIER-5-SPAN-SECX.dwg By: BunderCC

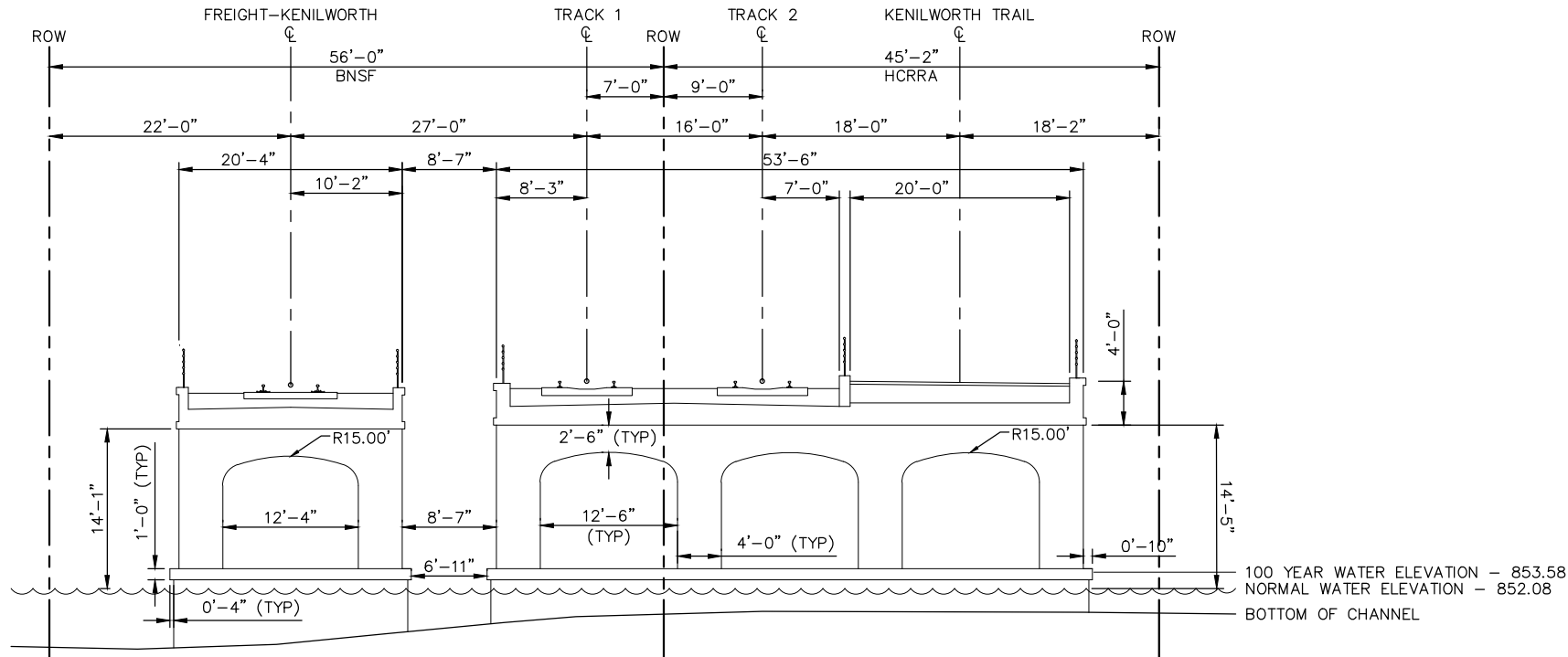

DRAFT-WORK IN PROCESS



**SOUTHWEST LIGHT RAIL**  
 CEDAR LAKE CHANNEL BRIDGE - ARCHED PIER  
 5 SPAN (2 PIERS WITHIN CHANNEL) - SECTION

Rev 0  
02/02/2015

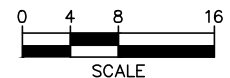

# STEEL PIER CONCEPT

DRAFT-WORK IN PROCESS



**SOUTHWEST LIGHT RAIL**  
CEDAR LAKE CHANNEL BRIDGE - STEEL PIER  
5 SPAN (2 PIERS WITHIN CHANNEL)

Rev 0  
02/02/2015



**Kimley»Horn**

Feb, 02 2015 11:01 am V:\3400\_ADC\CAD\SEGMENT E3\EXHIBITS\CHANNEL BRIDGE\VE3-CIV-STEEL-PIER-5-SPAN-ELEV.dwg By: BunderCC

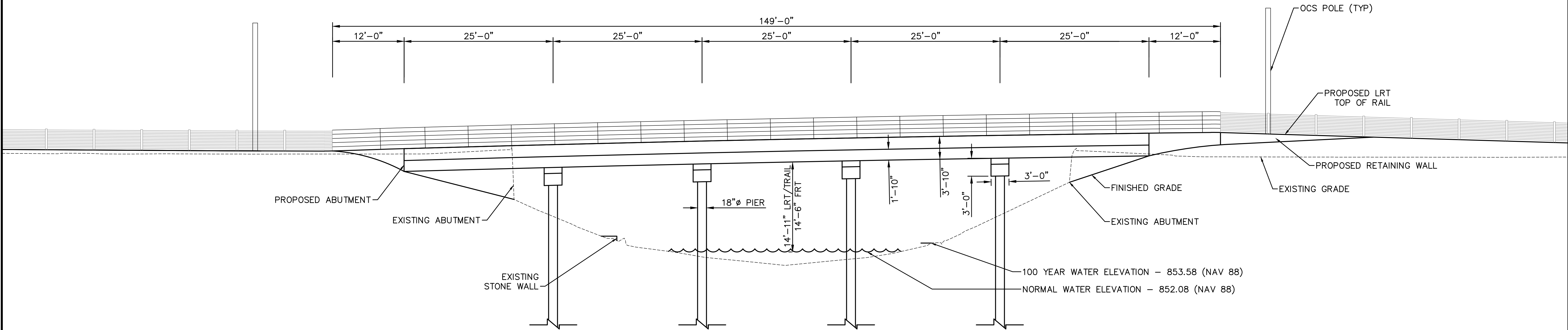

DRAFT-WORK IN PROCESS



**SOUTHWEST LIGHT RAIL**  
 CEDAR LAKE CHANNEL BRIDGE - STEEL PIER  
 5 SPAN (2 PIERS WITHIN CHANNEL)  
 TRAIL BRIDGE VIEW

Rev 0  
 02/02/2015

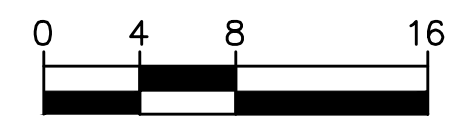

Feb, 02 2015 10:58 am V:\3400\_ADC\CAD\SEGMENT E3\EXHIBITS\CHANNEL BRIDGE\E3-CIV-FREIGHT-STEEL-PIER-5-SPAN-ELEV.dwg By: BunderCC

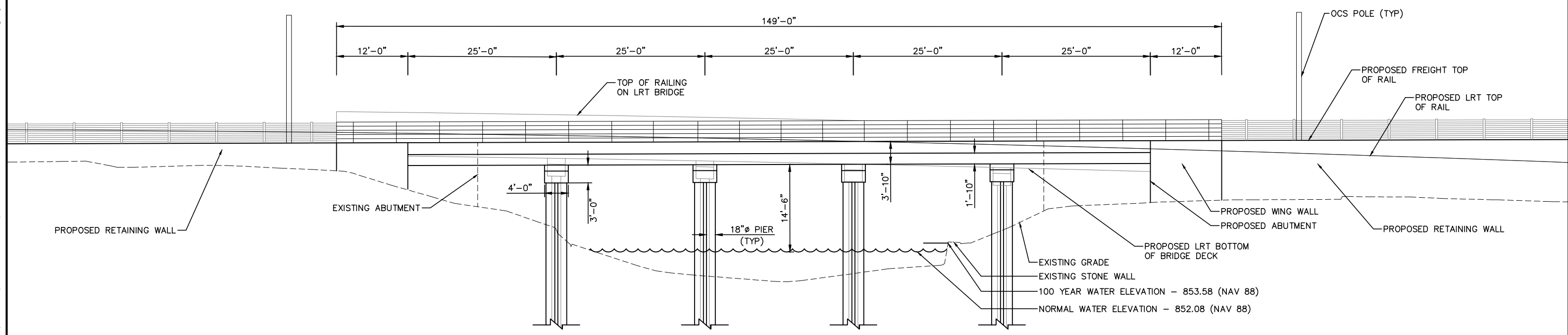

DRAFT-WORK IN PROCESS



**SOUTHWEST LIGHT RAIL**  
 CEDAR LAKE CHANNEL BRIDGE - STEEL PIER  
 5 SPAN (2 PIERS WITHIN CHANNEL)  
 FREIGHT BRIDGE VIEW

Rev 0  
 02/02/2015



Feb, 02 2015 09:25 am v:\3400\_ADC\CAD\SEGMENT E3\EXHIBITS\CHANNEL BRIDGE\E3-CIV-STEEL-PIER-5-SPAN-SECC.dwg By: BunderCC

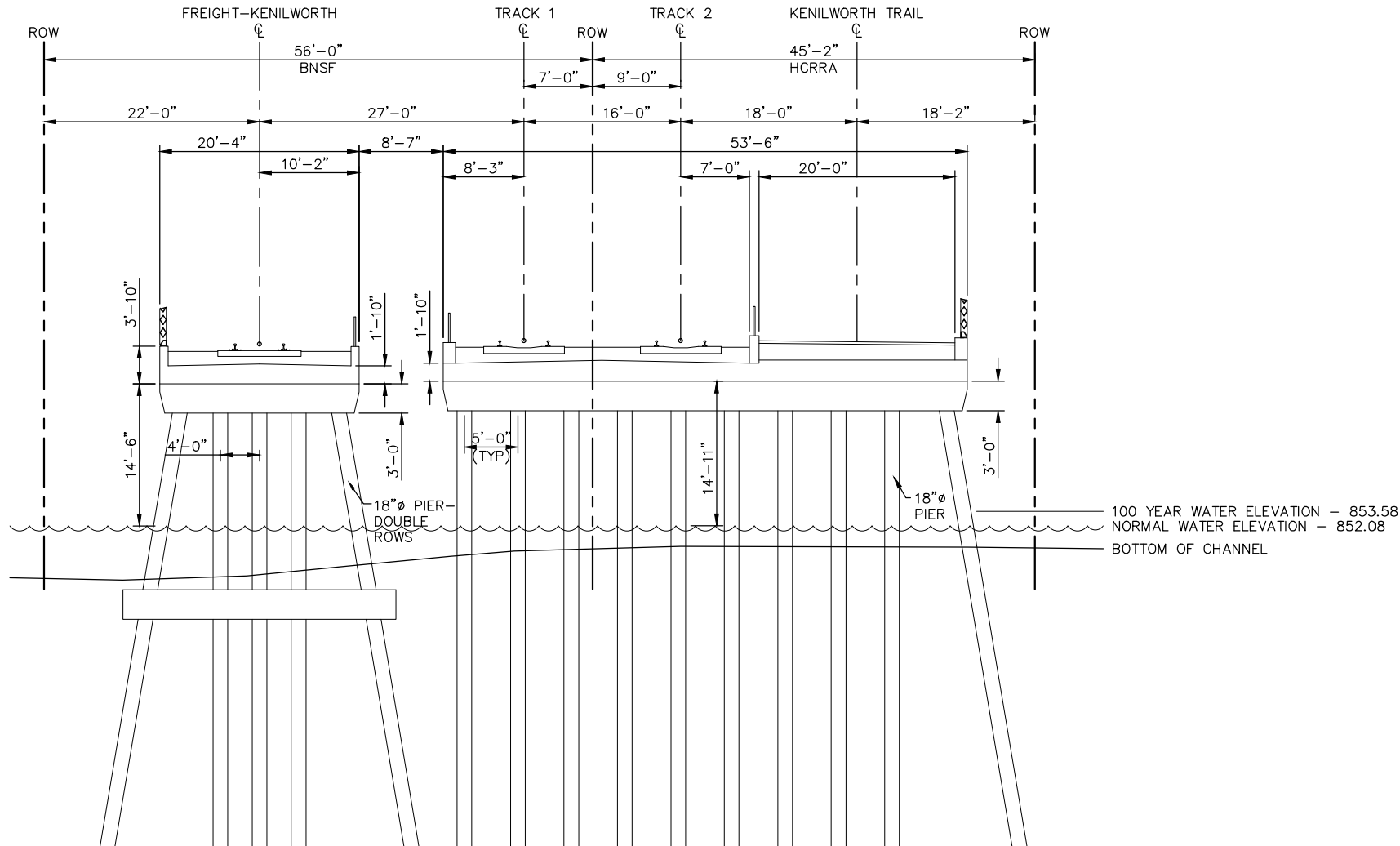

DRAFT-WORK IN PROCESS



**SOUTHWEST LIGHT RAIL**  
 CEDAR LAKE CHANNEL BRIDGE - STEEL PIER  
 5 SPAN (2 PIERS WITHIN CHANNEL) - SECTION

Rev 0  
02/02/2015

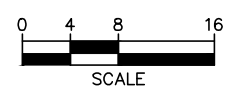

# THIN DECK CONCEPT

DRAFT-WORK IN PROCESS



**SOUTHWEST LIGHT RAIL**  
CEDAR LAKE CHANNEL BRIDGE - THIN DECK  
5 SPAN (2 PIERS WITHIN CHANNEL)

Rev 0  
02/02/2015



**Kimley»Horn**



Feb, 02 2015 11:04 am v:\3400\_ADC\CAD\SEGMENT E3\EXHIBITS\CHANNEL BRIDGE\E3-CIV-THIN-DECK-5-SPAN-ELEV.dwg By: BunderCC

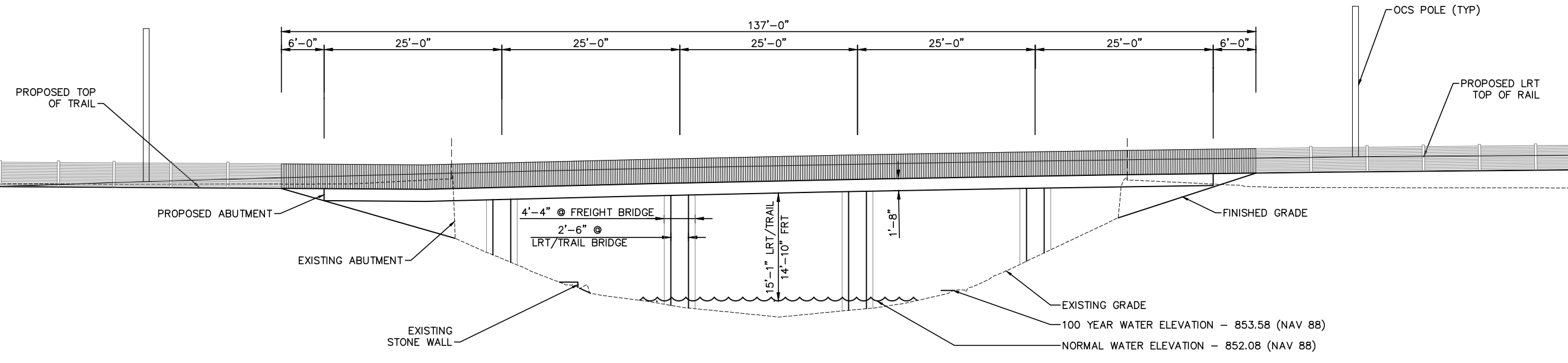

DRAFT-WORK IN PROCESS



**SOUTHWEST LIGHT RAIL**  
 CEDAR LAKE CHANNEL BRIDGE - THIN DECK  
 5 SPAN (2 PIERS WITHIN CHANNEL)  
 TRAIL BRIDGE VIEW

Rev 0  
02/02/2015

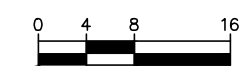

Feb, 02 2015 11:00 am v:\3400\_ADC\CAD\SEGMENT E3\EXHIBITS\CHANNEL BRIDGE\E3-CIV-FREIGHT-THIN-DECK-5-SPAN-ELEV.dwg By: BunderCC

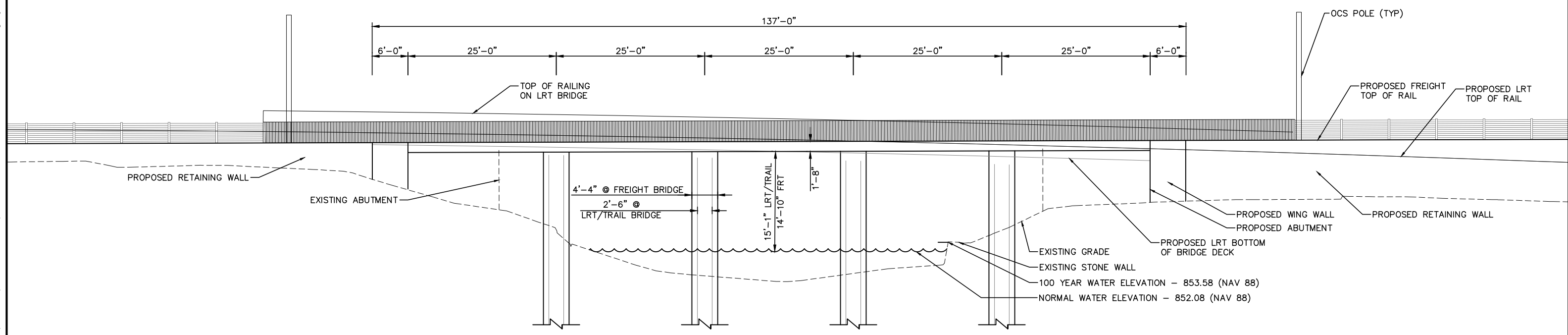

DRAFT-WORK IN PROCESS



**SOUTHWEST LIGHT RAIL**  
 CEDAR LAKE CHANNEL BRIDGE - THIN DECK  
 5 SPAN (2 PIERS WITHIN CHANNEL)  
 FREIGHT BRIDGE VIEW

Rev 0  
 02/02/2015

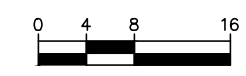

Feb, 02 2015 09:37 am v:\3400\_ADC\CAD\SEGMENT E3\EXHIBITS\CHANNEL BRIDGE\E3-CIV-THIN-DECK-5-SPAN-SECX.dwg By: BunderCC

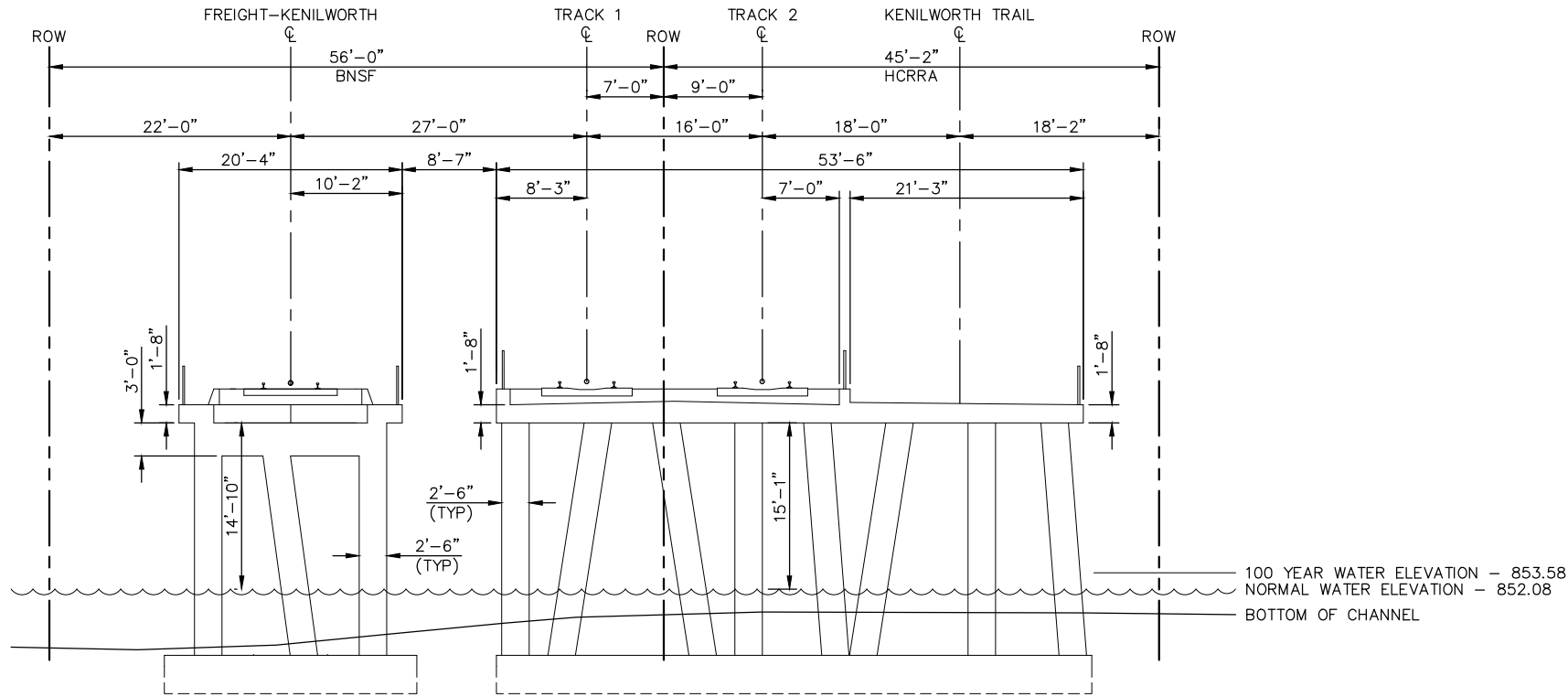

DRAFT-WORK IN PROCESS



**SOUTHWEST LIGHT RAIL**  
 CEDAR LAKE CHANNEL BRIDGE - THIN DECK  
 5 SPAN (2 PIERS WITHIN CHANNEL) - SECTION

Rev 0  
02/02/2015



Feb, 02 2015 09:42 am V:\3400\_ADC\CAD\SEGMENT E3\EXHIBITS\CHANNEL BRIDGE E3-CEDAR ISLES BRIDGE-OVERLAY-14 FOOT.dwg By: BunderCC

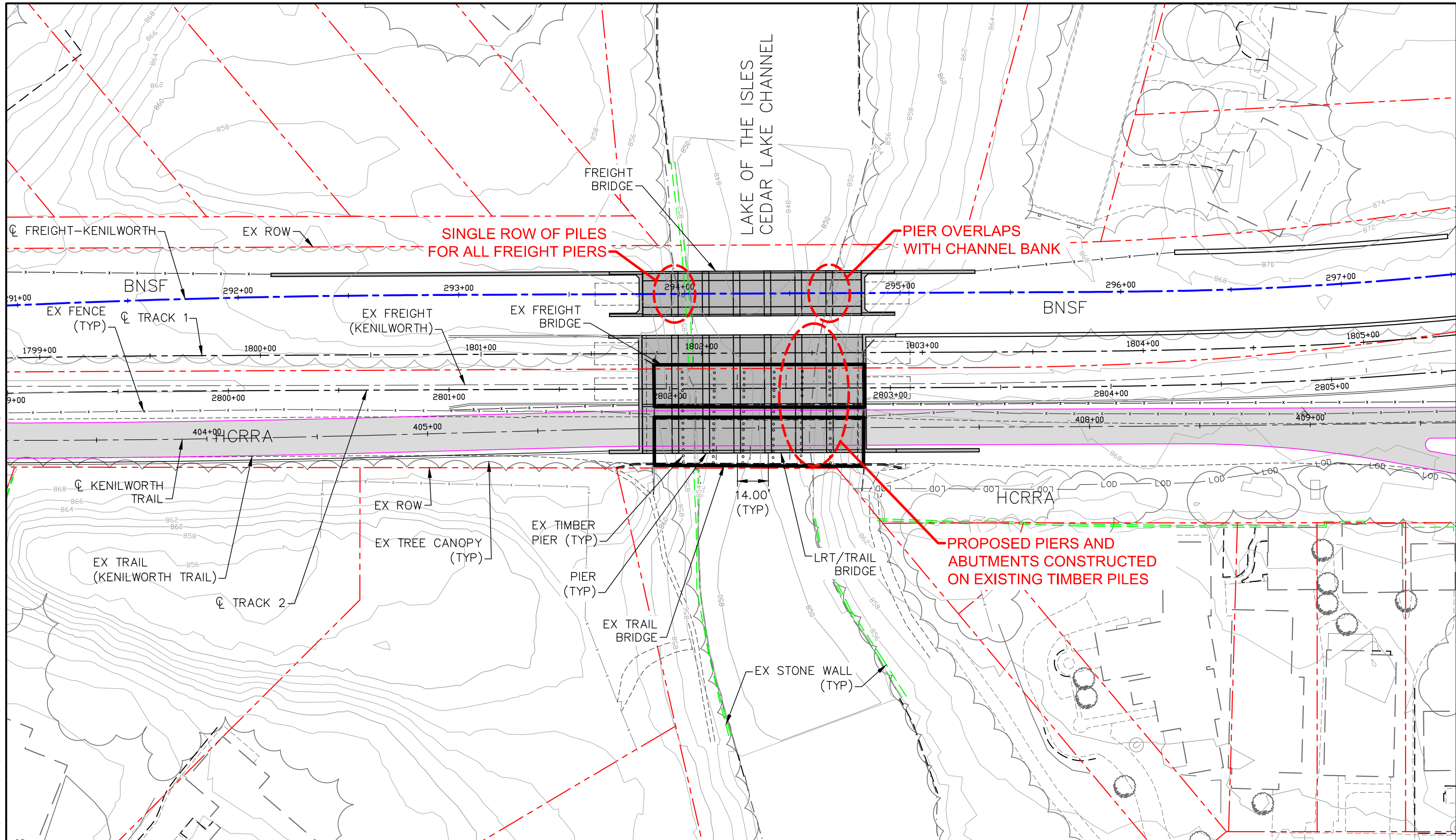

**SOUTHWEST LIGHT RAIL**  
 CEDAR LAKE CHANNEL BRIDGE - STEEL PIER  
 7 SPAN (4 PIERS WITHIN CHANNEL)

Rev 0  
 02/02/2015

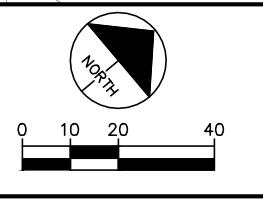

Feb, 02 2015 11:03 am v:\3400\_ADC\CAD\SEGMENT E3\EXHIBITS\CHANNEL BRIDGE\VE3-CIV-STEEL-PIER-7-SPAN-ELEV.dwg By: BunderCC

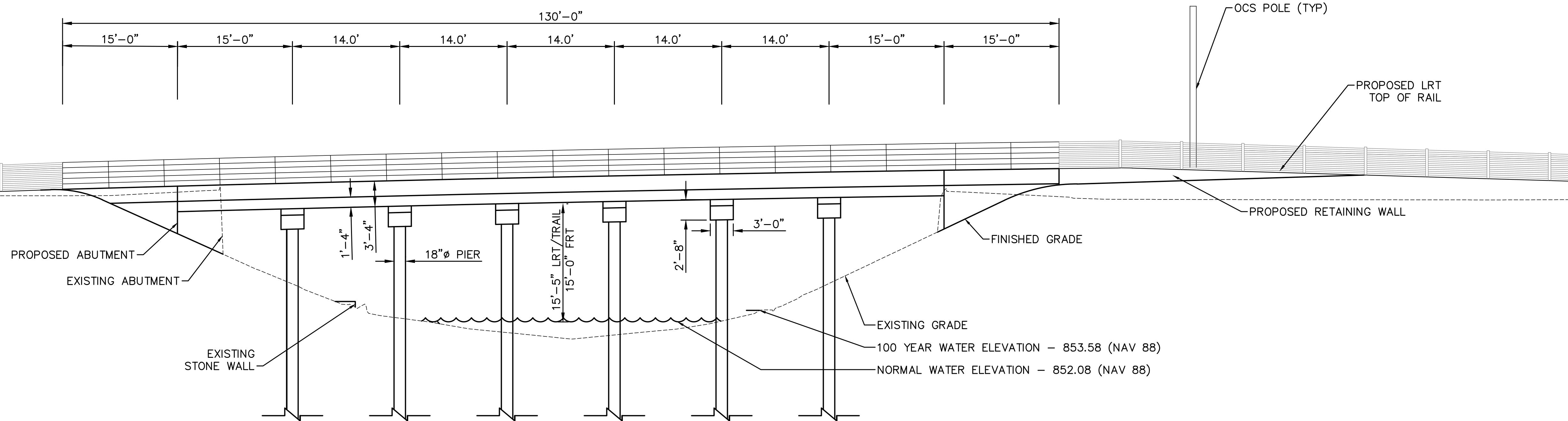

DRAFT-WORK IN PROCESS



**SOUTHWEST LIGHT RAIL**  
 CEDAR LAKE CHANNEL BRIDGE - STEEL PIER  
 7 SPAN (4 PIERS WITHIN CHANNEL)  
 TRAIL BRIDGE VIEW

Rev 0  
02/02/2015

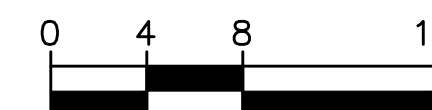

Feb, 02 2015 10:59 am V:\3400\_ADC\CAD\SEGMENT E3\EXHIBITS\CHANNEL BRIDGE\E3-CIV-FREIGHT-STEEL-PIER-7-SPAN-ELEV.dwg By: BunderCC

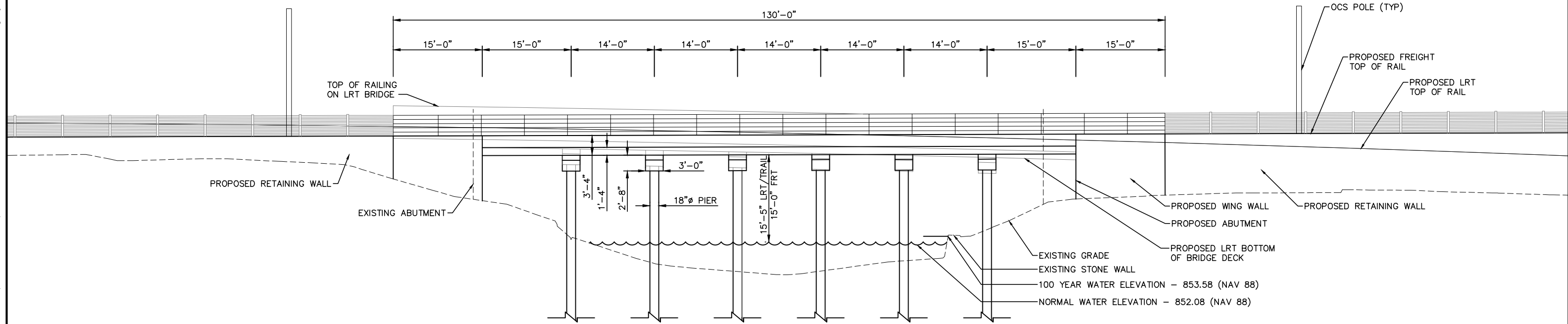

DRAFT-WORK IN PROCESS



**SOUTHWEST LIGHT RAIL**  
 CEDAR LAKE CHANNEL BRIDGE - STEEL PIER  
 7 SPAN (4 PIERS WITHIN CHANNEL)  
 FREIGHT BRIDGE VIEW

Rev 0  
 02/02/2015

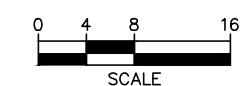

Feb, 02 2015 09:53 am v:\3400\_ADC\CAD\SEGMENT E3\EXHIBITS\CHANNEL BRIDGE\E3-CIV-STEEL-PIER-7-SPAN-SECC.dwg By: BunderCC

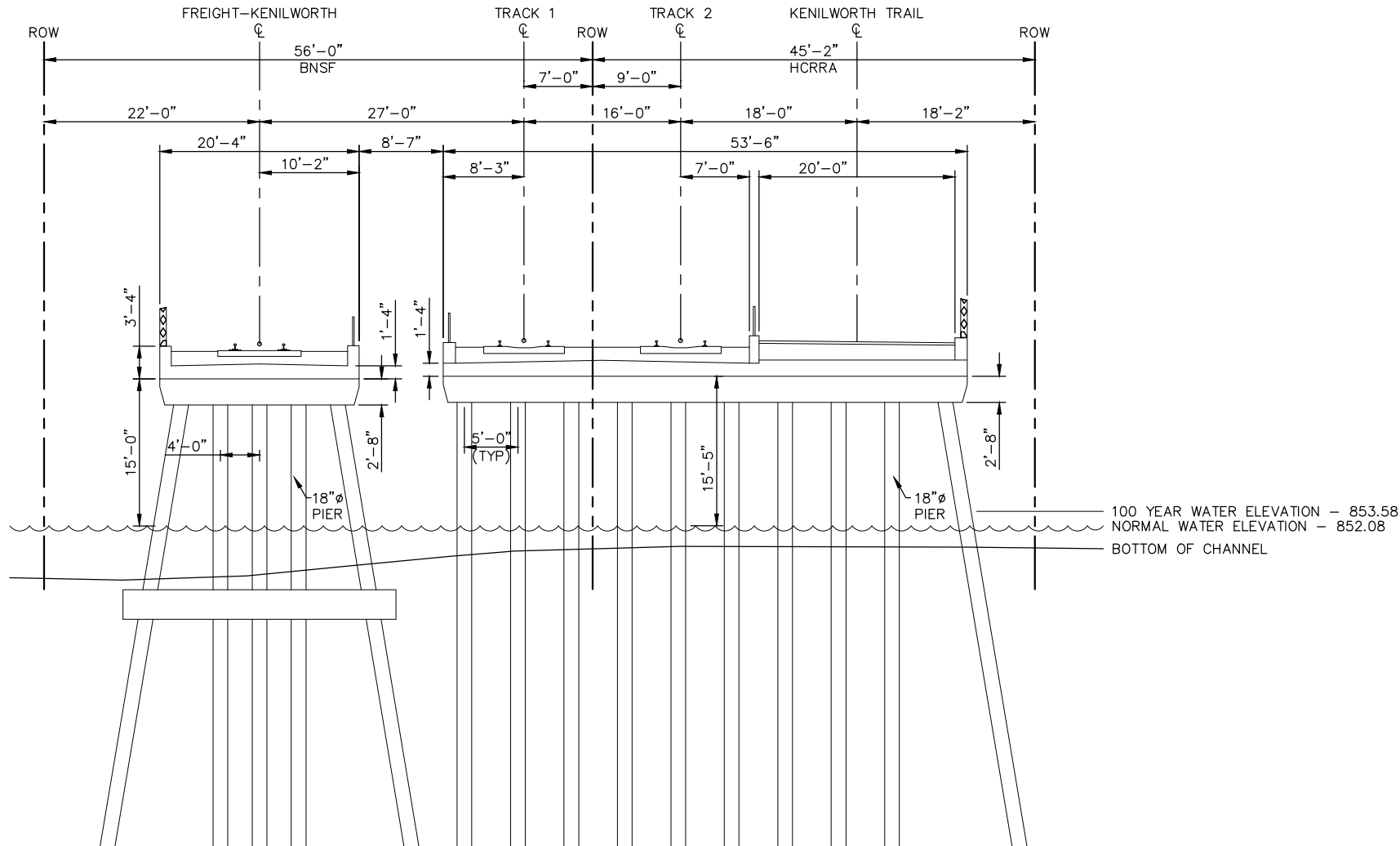

DRAFT-WORK IN PROCESS



**SOUTHWEST LIGHT RAIL**  
 CEDAR LAKE CHANNEL BRIDGE - STEEL PIER  
 7 SPAN (4 PIERS WITHIN CHANNEL) - SECTION

Rev 0  
02/02/2015

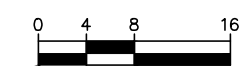



## **Kenilworth Lagoon/Channel Revised Bridge Design Concepts: Railing Study**

*Revised renderings of railing concepts for Steel Pier and Thin Deck concepts<sup>1</sup>*

---

<sup>1</sup> All bridge design concepts shown in this section are on 4 span structures.





DRAFT - WORK IN PROCESS



**KENILWORTH CORRIDOR**  
CHANNEL BRIDGE CONCEPTS - EXISTING  
VIEW 3

NOVEMBER 2014



**Kimley»Horn**  
**miller dunwiddie**  
ARCHITECTURE

# CONCEPT STEEL PIER

**DRAFT - WORK IN PROCESS**



**KENILWORTH CORRIDOR**  
CHANNEL BRIDGE CONCEPTS - STEEL PIER

FEBRUARY 2015





DRAFT - WORK IN PROCESS



**KENILWORTH CORRIDOR**  
CHANNEL BRIDGE CONCEPTS - STEEL PIER  
VIEW 3 - REV 1

FEBRUARY 2015





**DRAFT - WORK IN PROCESS**



**KENILWORTH CORRIDOR**  
CHANNEL BRIDGE CONCEPTS - STEEL PIER  
VIEW 3 - REV 1A

FEBRUARY 2015



**Kimley»Horn**



DRAFT - WORK IN PROCESS



**KENILWORTH CORRIDOR**  
CHANNEL BRIDGE CONCEPTS - STEEL PIER  
VIEW 3 - REV 1B

FEBRUARY 2015



**Kimley»Horn**



**DRAFT - WORK IN PROCESS**



**KENILWORTH CORRIDOR**  
CHANNEL BRIDGE CONCEPTS - STEEL PIER  
VIEW 3 - REV 1C

FEBRUARY 2015



# CONCEPT THIN DECK

**DRAFT - WORK IN PROCESS**



**KENILWORTH CORRIDOR**  
CHANNEL BRIDGE CONCEPTS - THIN DECK

FEBRUARY 2015



**Kimley»Horn**



DRAFT - WORK IN PROCESS



**KENILWORTH CORRIDOR**  
CHANNEL BRIDGE CONCEPTS - THIN DECK  
VIEW 3

NOVEMBER 2014



**Kimley»Horn**





DRAFT - WORK IN PROCESS



**KENILWORTH CORRIDOR**  
CHANNEL BRIDGE CONCEPTS - THIN DECK  
VIEW 3 - REV 1

FEBRUARY 2014



**Kimley»Horn**