

**GENERAL PLAN**

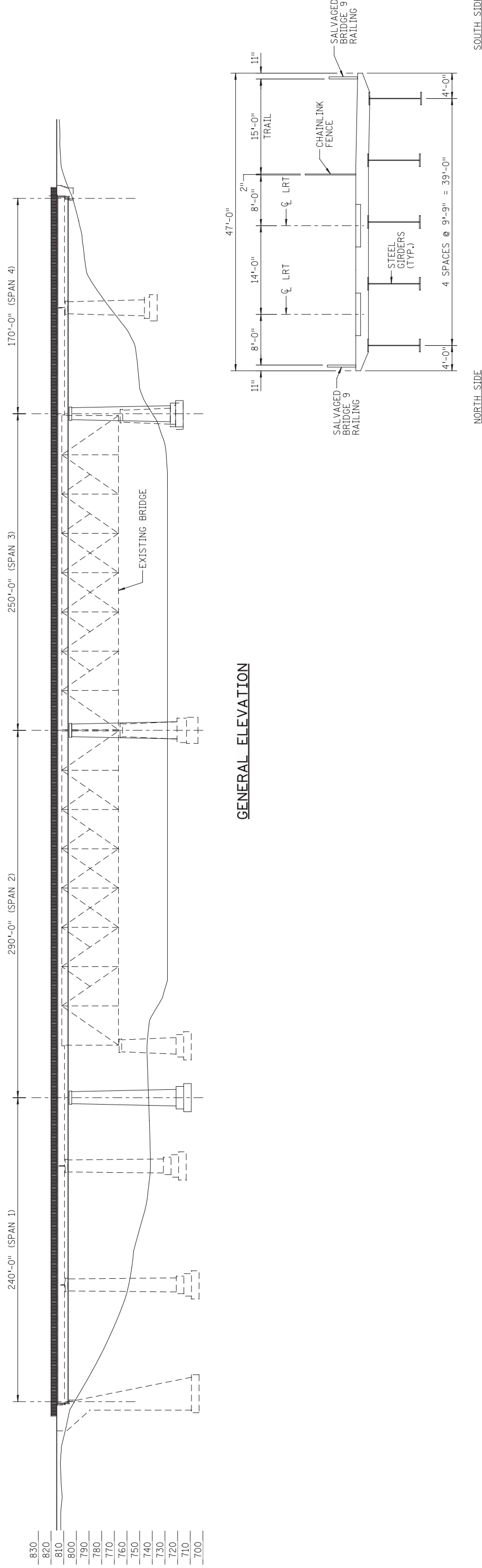

**GENERAL ELEVATION**

**TYPICAL PROPOSED SECTION OF BRIDGE NO. 9**

### **Washington Avenue at 19th Avenue South**

19th Avenue S Bridge over the Washington Avenue would not need to be replaced. The new roadway, LRT tracks and trail would be constructed within the space provided by the existing bridge piers (Figure 2; B3).

### **Law School Entrance**

The entrance to the parking lot adjacent to Mondale Hall would be reconstructed to provide a bridge over the Law School “cut” containing the LRT tracks (Figure 2; B4). The location and connecting points of this roadway would not change.

### **2nd Street at 19th Avenue South**

The connection of 2nd Street to 19th Avenue South would be reconstructed to provide a bridge over the narrow cut containing the LRT tracks (Figure 2; B-5).

#### **2.3.2.2 Retaining Walls <sup>6</sup>**

There are three locations in the West Bank area where retaining walls will be required.

- After crossing I-35W, the alignment follows the southern boundary of the Washington Avenue right-of-way. South of the right-of-way the adjacent development is at the higher street level. The existing side slope would be removed and replaced with a retaining wall 450 feet long (Figure 2; W1). There will be some disruption to the streets and parking lot south of the retaining wall during construction, but both the streets and the parking lot will be restored after construction is complete.
- On the north side of the Washington Avenue right-of-way, a retaining wall would extend from the Cedar Avenue S Bridge toward the 19th Avenue S Bridge (Figure 2; W2).
- Between the Law School and 19th Avenue S, a narrow cut of about 30 feet wide would be developed using two retaining walls (Figure 2; W3). Figure 7 shows a cross section of this cut.

#### **2.3.3 Reconfiguration of Existing Roadways <sup>7</sup>**

I-35W separates the University of Minnesota West Bank campus from the Minneapolis downtown area. On either side of I-35W, the street network reflects the historic grid pattern that existed before the construction of freeways through the area.

A depressed four-lane divided roadway crosses under I-35W and connects the Downtown to the campus and to I-35W by way of an interchange. Washington Avenue is in a depressed cut that separates the roadway from the surrounding land

---

<sup>6</sup> **Note:** Additional enhancements are proposed in Chapter 8 that refines the alignment and mitigates potential impacts.

<sup>7</sup> **Note:** Additional enhancements are proposed in Chapter 8 that refines the alignment and mitigates potential impacts.

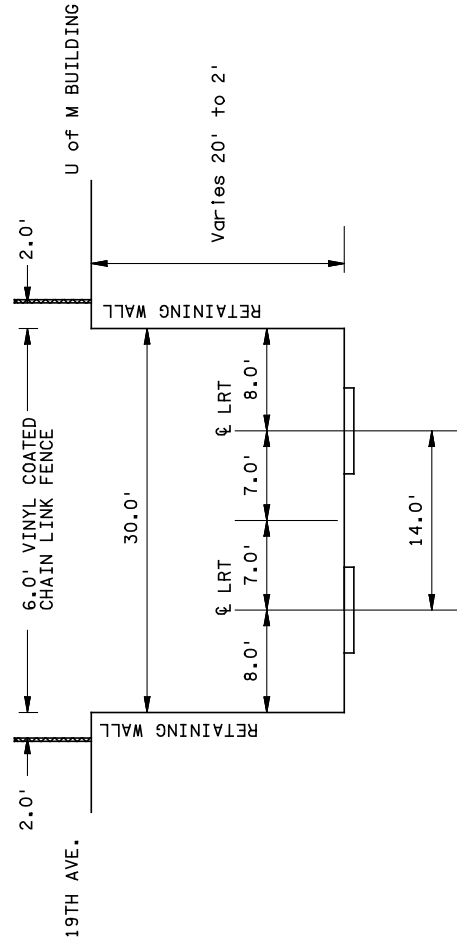
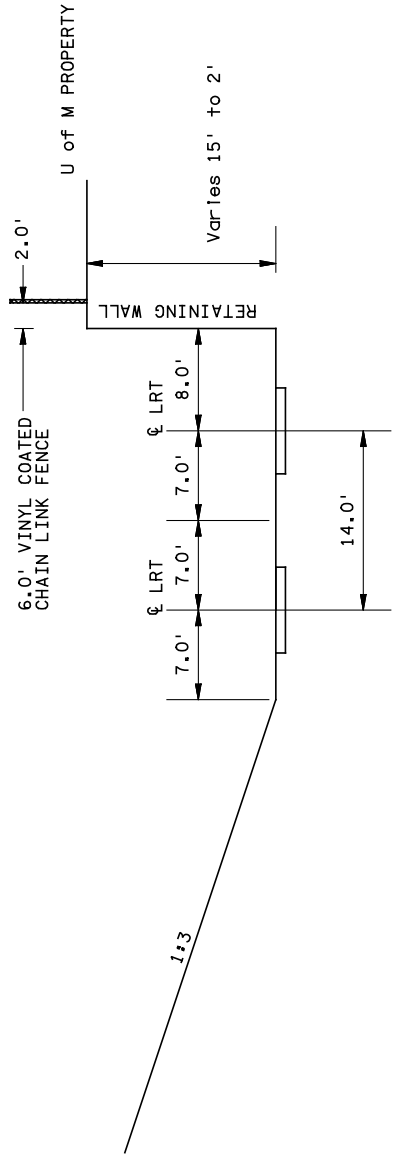

**Typical Cross Sections - West Bank**  
 Central Corridor LRT Northern Alignment Alternative  
 University of Minnesota



**Figure 7**

use; an interchange is located at Cedar Avenue S. Washington Avenue continues to a bridge crossing the Mississippi River, known locally as the Washington Avenue Bridge, which connects the University of Minnesota West Bank campus to the East Bank campus. Buildings associated with the West Bank campus are located both north and south of Washington Avenue and are connected by a skyway connecting Blegen Hall to Willey Hall.

In order to accommodate the placement of LRT, several modifications would need to be made to Washington Avenue. The main feature of these changes is the replacement of the interchange at Cedar Avenue S with an intersection that would be located at the level of Washington Avenue (Figure 2; R1). The north leg of this intersection would provide access to Cedar Avenue with a connection to the north end of the Cedar Avenue S Bridge (Figure 2; R3). The south leg of this new intersection would be the connection point for the realignment of the NB I-35W off-ramp that currently connects to EB Washington Avenue (Figure 2; R2). This new configuration creates the space necessary to place LRT on the south side of the existing Washington Avenue right-of-way. Figure 8 is a cross section illustrating the relationship of a realigned Washington Avenue to the LRT tracks, just east of the station area.

At street level, the intersections at both ends of the Cedar Avenue S Bridge would be redesigned. On the north end, the WB off-ramp from Washington Avenue would be eliminated. The WB leg of the new intersection would connect to Washington Avenue (Figure 2; R3). On the south end of the bridge, the EB off-ramp would be eliminated. Third Street South would be realigned to intersect Cedar Avenue S at a ninety-degree angle.

The University of Minnesota shipping and receiving dock in Heller Hall would have its entrance shifted from 3rd Street S to a direct connection to Washington Avenue.

The connecting roadway between 19th Avenue S and 1st Street S would need to be shifted to intersect at the reconstructed intersection of 1st Street S and 22nd Avenue S (Figure 2; A5). Figure 9 illustrates how this new city street connection parallels the LRT tracks. This new intersection would also provide a driveway connection to the Riverview Tower Building, a 27-floor high-rise residential tower.

### 2.3.4 Trails

An existing trail referred to as the U of M Bikeway crosses Bridge 9, connecting the East Bank of the University to West River Road Parkway and ultimately toward downtown Minneapolis. Plans are in place to extend this trail in both directions.

The existing trail across Bridge 9 would be accommodated on the new bridge at this site, being placed on the east side of the bridge adjacent to the LRT tracks. The trail would then be extended farther to the east to the University Transitway trail. It would continue to follow the CCLRT Alignment on the south side through the Dinkytown area and connect with the existing trail at 23rd Avenue SE.

*The existing trail across Bridge 9 would be accommodated on the new bridge at this site.*



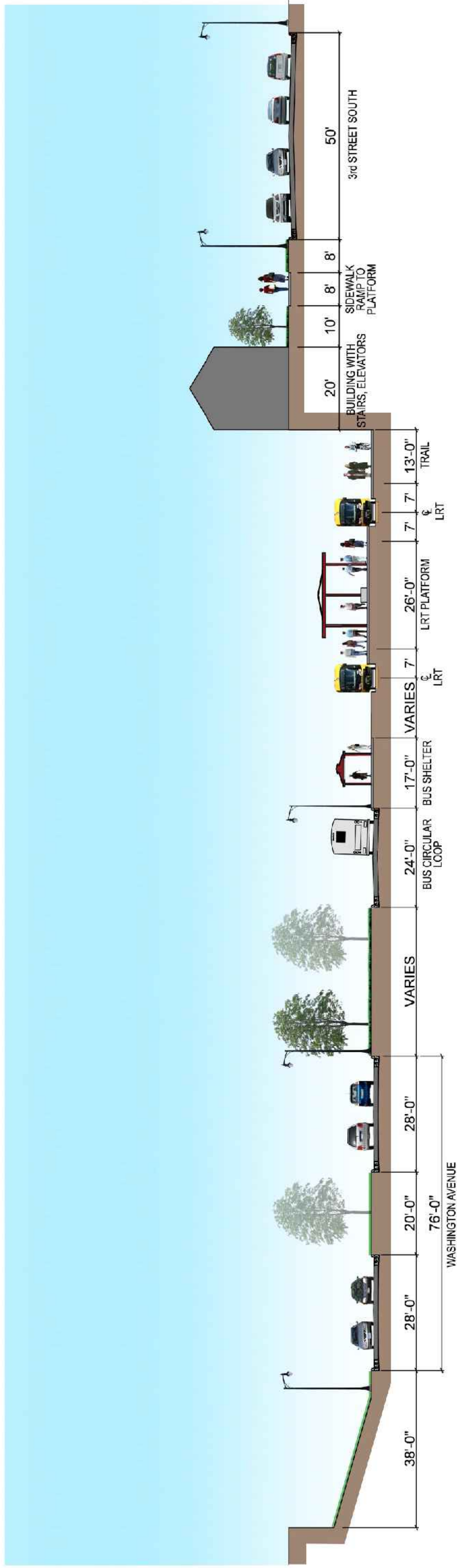

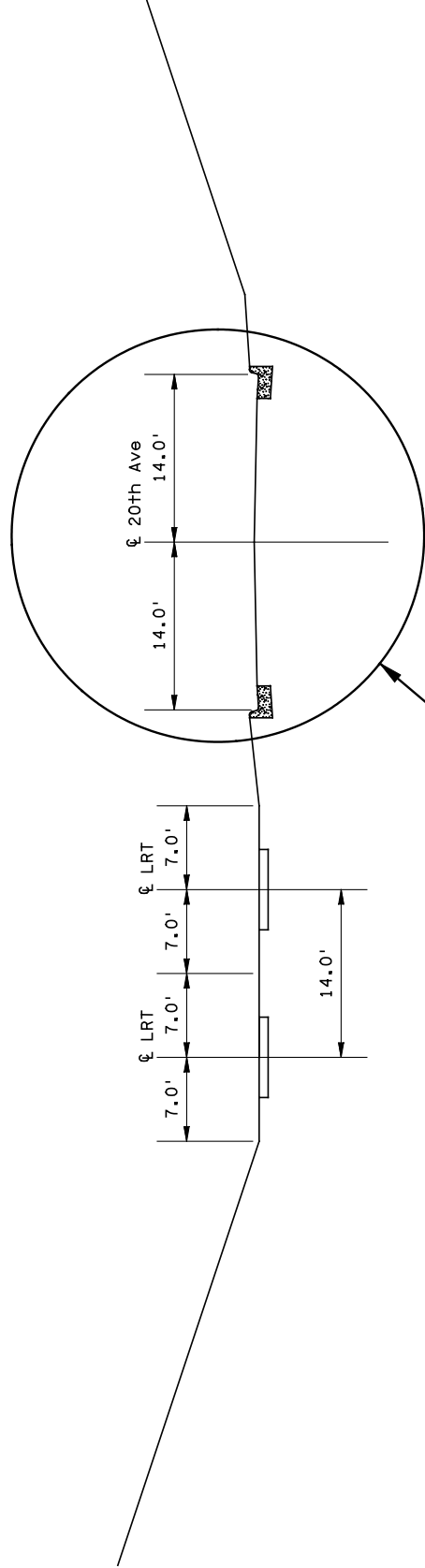

Enhancements in this area are described in Chapter 8

Since the Central Corridor Management Committee meeting of April 30, 2008, continued feasibility design development of the Northern Alignment has resulted in further enhancements which are further described in Chapter 8 of this report.



**Typical Cross Section - Tracks through U of M Ball Fields**  
 Central Corridor LRT Northern Alignment Alternative  
 University of Minnesota



**Figure 9**

### 2.3.5 Utility Relocations

A preliminary review of potential utility relocations reveals that there are very few utility conflicts along the Northern Alignment. The only section of the alignment where this would be an issue is along 19th Avenue S near the Law School trench (Figure 10). A water main, storm sewer and sanitary sewer that parallel 19th Avenue S would be affected because they would be in the tieback area for the western retaining wall of the trench. Shifting these lines to the west would eliminate this conflict. A sanitary sewer and storm water sewer also cross the trench at 2nd Street S. The sanitary sewer would be rerouted to 1st Street S; the storm water sewer would be rerouted towards Washington Avenue. In both cases the need to cross the trench would be eliminated. Overall, there is minimal utilities impact along this alignment. The number of utility conflicts may be so small that significant savings to the schedule, up to a construction season, could be realized with this alternate alignment.

*There is minimal utilities impact on along this alignment. The number of utility conflicts may be so small that significant savings to the schedule, up to a construction season, could be realized with this alternate alignment.*

## 2.4 East Bank<sup>8</sup>

### 2.4.1 Track Alignment

After crossing Bridge 9, the Northern Alignment is situated within the right-of-way of the U of M and Burlington Northern Santa Fe (BNSF) railroad. The Minnesota Commercial Railroad operates an industrial spur track within this right-of-way that connects on the East to the BNSF at Union Yard. The spur extends to the West to the site of the I-35W Bridge. Prior to the collapse of the original bridge in August 2007, the spur continued farther to the west but has now been truncated to accommodate the design of the new I-35W Bridge. This spur track continues to serve the University of Minnesota, which receives fuel for use in its heating plant, and 'D' yard, a public team track.

Although only one freight track remains, in earlier years, when the railroad still entered downtown Minneapolis and also served several industries along the north bank of the river, several tracks occupied this right-of-way. Consequently the corridor is over 120 feet wide. Through the Dinkytown commercial area, the corridor is in a cut that places the railroad below street level. Several bridges have been constructed in this area that maintain the grid pattern of the area street system, mitigating what would normally be a barrier effect on the neighborhood.

After crossing Bridge 9, the Northern Alignment would follow the original railroad alignment that passes between the heating plant complex and the Education Sciences Building (Figure 3; A7). Although relatively narrow, the space available between the heating plant complex and the Education Sciences Building is wide enough to accommodate two LRT tracks and an eight-foot trail as shown in Figure 11.

*Although relatively narrow, the space available between the heating plant complex and the Education Sciences Building is wide enough to accommodate two LRT tracks and an 8-foot trail.*

---

<sup>8</sup> **Note:** Additional enhancements are proposed in Chapter 8 that refines the alignment and mitigates potential impacts.



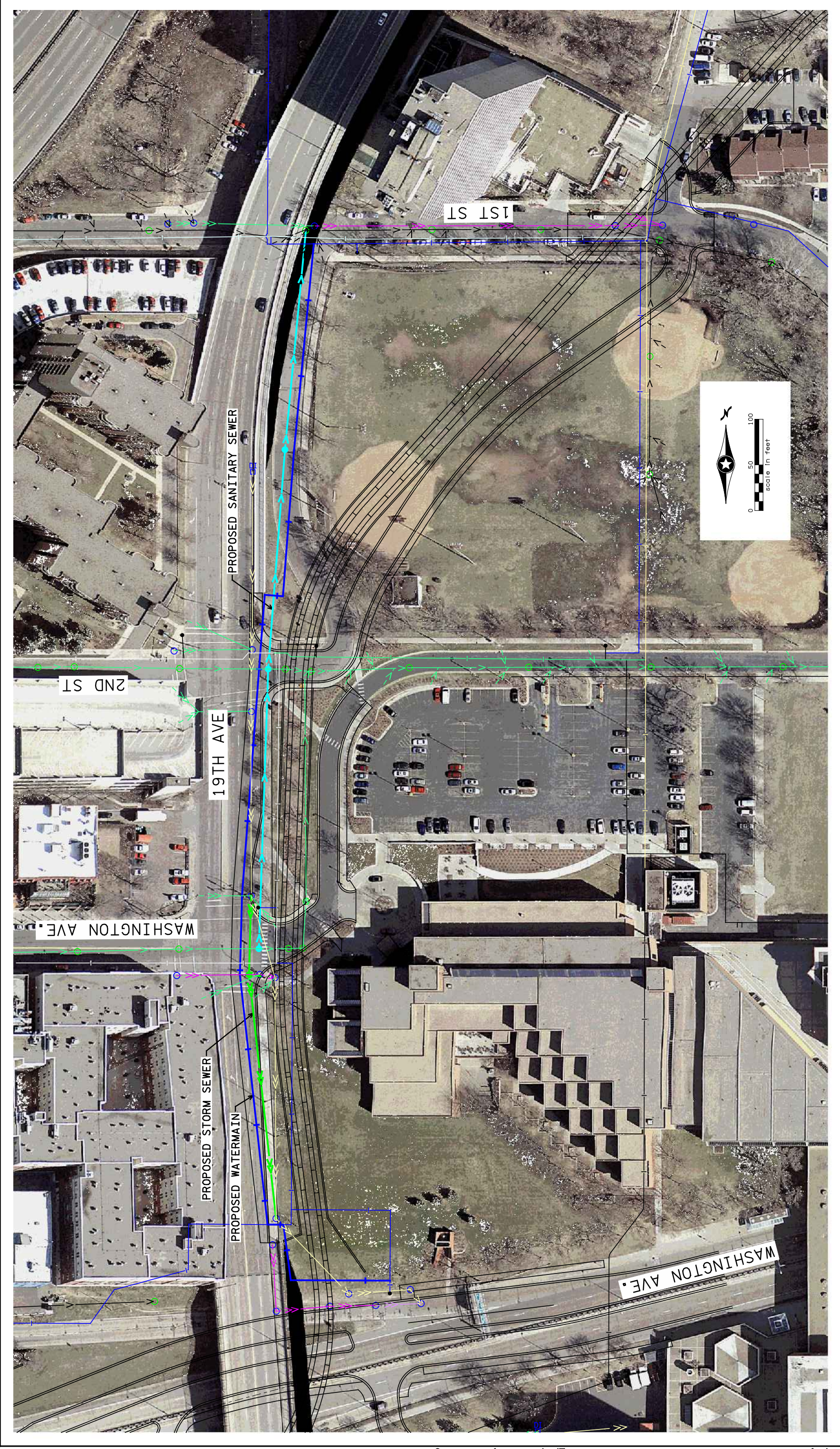

h:\projects\6399\HI-MUL\LAYOUT\FEASIBILITY STUDY\6399\_proposedutilityrelocates.dgn

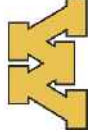

Since the Central Corridor Management Committee meeting of April 30, 2008, continued feasibility design development of the Northern Alignment has resulted in further enhancements which are described in Chapter 8 of this report.



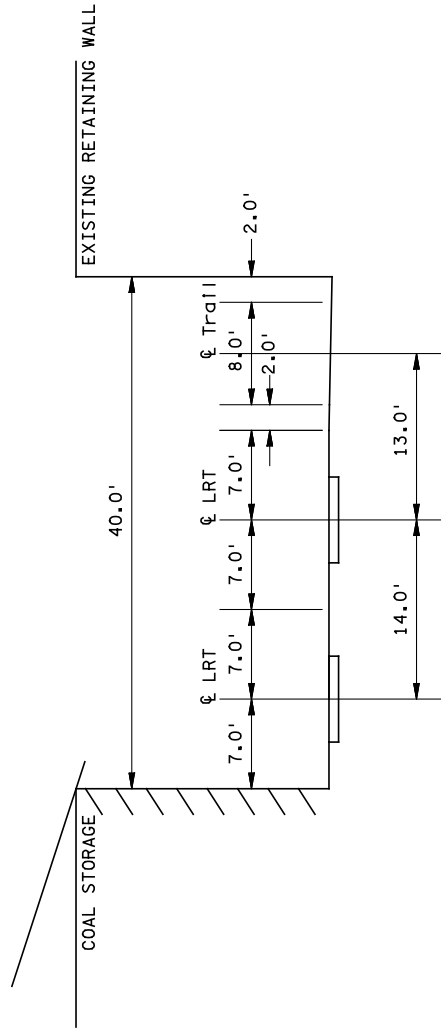

### Typical Cross Section - 8' Trail Between Historic Wall and Coal Storage

Central Corridor LRT Northern Alignment Alternative  
University of Minnesota



Figure 11

From the south end of Bridge 9 to just north of the U of M heating plant, the Northern Alignment follows the path of an abandoned railroad. North of the heating plant, the Northern Alignment enters an active rail corridor. Historically, the corridor provided access to downtown Minneapolis via the Stone Arch bridge and to the Milling District on the north side of the Mississippi River. Today, tracks end at the site of the I-35W Bridge. While owned by BNSF, the Minnesota Commercial operated a team track, known as 'D' yard, north and west of the heating plant. A team track is where rail cars can be loaded or unloaded by shippers/receivers who do not have their own on-site rail facilities. The Minnesota Commercial also delivers coal to the University heating plant.

Although still being used on a regular basis, and playing a valuable role in the freight movement in the Twin Cities, there is a proposal to use part of this right-of-way to construct a parkway known as Granary Road, connecting 11th Avenue SE to 25th Avenue SE. The proposed design of the Northern Alignment would allow the continuation of freight service, including deliveries to the University and the operation of 'D' yard. The design would also accommodate Granary Road and a transportation trail. Figure 12 is a cross section of the railroad cut that illustrates the relationship of each of these elements. The Northern Alignment would continue to follow the railroad alignment to 21st Avenue SE (Figures 2, 3; A8)

*Besides allowing the continuation of freight service, the proposed Northern Alignment would also allow the addition of a new parkway, Granary Road, and the introduction of a transportation trail.*

## 2.4.2 Structures

### 2.4.2.1 Bridges

#### Dinkytown Pedestrian Bridge

The Dinkytown pedestrian bridge, which is now closed due to structural concerns, connects University Avenue SE to the East Bank campus, crossing the railroad right-of-way (Figure 3; B6). A new bridge would be constructed in the same location. This new bridge will also provide a stair connection to the LRT platform as described in the station section below.

*The bridge piers and supports are designed to parallel the path of the railroad right-of-way and would not be disrupted or modified in any way to accommodate the construction and operation of LRT or the other facilities that would be placed under the bridges.*

#### Dinkytown Street Bridges

Systems of bridges are situated at the intersection of University Avenue SE (Figure 3; B7) and 14th Avenue SE and the intersection of 4th Street SE and 15th Avenue SE (Figure 3; B8). An additional bridge is located on 5th Street SE between 15th Avenue SE and 17th Avenue SE (Figure 3; B9). These bridges are designed to maintain the grid street pattern over a railroad right-of-way that crosses diagonally through the area. The bridge piers and supports are designed to parallel the path of the railroad right-of-way and would not be disrupted or modified in any way to accommodate the construction and operation of LRT or the other facilities that would be placed under the bridges.

### 2.4.2.2 Retaining Walls

No changes to the existing retaining walls in this area would be necessary. This includes the retaining wall near the Education Sciences Building (Figure 3; W4).

*No changes to the existing retaining walls in this area would be necessary. This includes the retaining wall near the Education Sciences Building.*



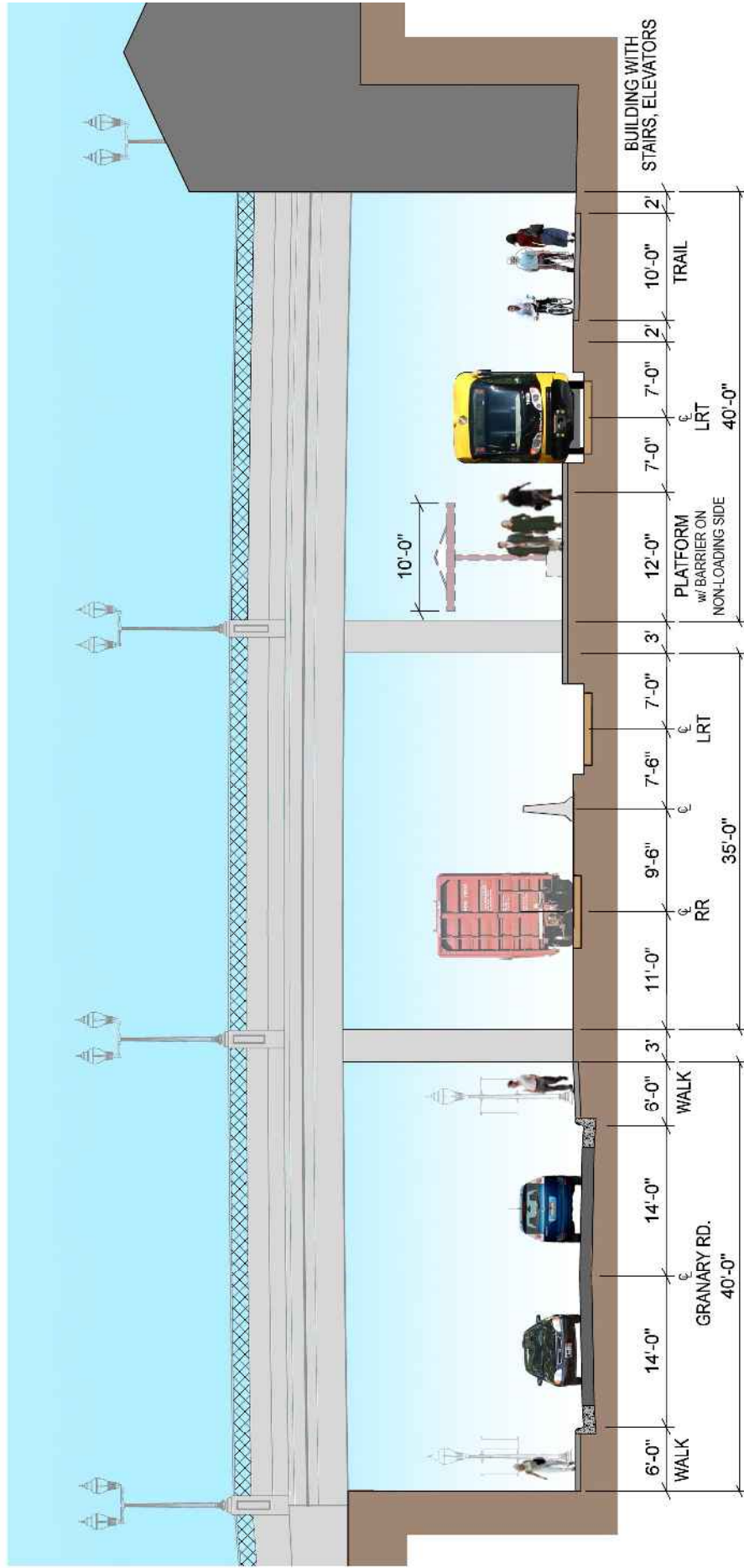

**Typical Cross Section - With Heavy Rail, Granary Road, and 10' Trail**  
 Central Corridor LRT Northern Alignment Alternative  
 University of Minnesota



**Figure 12**

### 2.4.3 Reconfiguration of Existing Roads

No changes to the existing roadway system in this area would be necessary.

### 2.4.4 Trails

No changes to the existing trail system in this area would be necessary. Any trails in this areas that is implemented prior to the construction of the CCLRT would be replaced.

## 2.5 Stadium Village Area

### 2.5.1 Track Alignment

The Northern Alignment would leave the railroad right-of-way near 21st Avenue SE. The alignment would then turn 90 degrees to the south and parallel 23rd Avenue SE on the west side of the street. At the University of Minnesota Transitway, the alignment would turn 90 degrees to the east and parallel the Transitway (Figure 4; A9). A station would be located between 23rd Avenue SE and 25th Avenue SE, parallel to and just south of the Transitway (Figure 4; S3).

*The Northern Alignment has been designed such that no additional changes to the street network would be required.*

### 2.5.2 Structures

There are no bridges, retaining walls or other structures affected or needed in the Stadium Village segment.

### 2.5.3 Reconfiguration of Existing Roads

The street network in this area has been reconstructed as part of the construction of the University of Minnesota football stadium. The Northern Alignment has been designed such that minimal changes to the street network would be required.

*The Northern Alignment will accommodate all of these proposed roadways and trails.*

### 2.5.4 Trails

No changes to the existing trail system in this area would be necessary. Any trails that are implemented prior to the construction of the CCLRT would be replaced.

## 2.6 Roadways and Trails Not in Northern Alignment

Assessing the feasibility of the proposed Northern Alignment has been conducted with consideration for other plans along the proposed alignment. The City of Minneapolis and the University of Minnesota have been considering several changes to the roadway and trail system in the area. The Northern Alignment will accommodate all of these proposed roadways and trails. The most significant ones are described below.



## 2.6.1 Roadways

### 2.6.1.1 Granary Road

The name ‘Granary Road’ reflects both the location of the proposed roadway and Minneapolis’ heritage as a flour milling center. The roadway, which would be constructed as a two-lane Parkway, would connect 11th Avenue SE, near the mill district on the north side of the Mississippi River, to 25th Avenue SE easterly beyond the University Stadium. The alignment of the proposed roadway would follow the BNSF right-of-way from 11th Avenue SE to 25th Avenue SE.

The roadway would be separated grade through the Dinkytown commercial area with no access between 11th Avenue SE and 5th Street SE. Additional access points would be provided at 17th Avenue SE Oak Street SE, 23rd Avenue SE and 25th Avenue SE.

The Northern Alignment is situated in the railroad right-of-way in a way that allows adequate space to accommodate for Granary Road, the trails, sidewalks, and the freight railroad. West of 17th Avenue SE, Granary Road would be farthest to the North. This is important because the roadway leaves the railroad corridor area and proceeds to the west toward 11th Avenue SE.

Having Granary Road on the north makes it possible to construct Granary Road without any LRT grade crossings affecting through traffic. There would be LRT grade crossings on the intersecting roadway at 17th Street SE and at Oak Street SE. Left and right turns lanes would be provided on Granary Road at these intersections to provide a place for traffic to wait for a passing train.

*It is possible to construct Granary Road without any LRT grade crossings affecting through traffic.*

The BNSF and U of M railroad would cross Granary Road at-grade near 17th Avenue SE.

Though not directly connected to Dinkytown, the area would benefit from the new roadway by diverting through traffic from University Avenue SE and 4th Street SE, easing traffic congestion in the area. It would also provide access to a large area of underutilized industrial and railroad land that is considered a development opportunity for the City. It is expected that Granary Road would be extended farther to the east, at least as far as TH 280, as redevelopment of the area allows.

### 2.6.1.2 Future East River Road Connection with Main Street

East River Road, which follows the eastern shore of the Mississippi River, currently ends at Pillsbury Drive SE. There is a proposal to construct a bridge connection to the west in such a way that a connection could be provided to Main Street. However, because of grade differentials, there would not be a connection between the new East River Road/Main Street SE and Granary Road.

The proposed Northern Alignment envisions this new bridge crossing both the LRT tracks and the freight railroad tracks. This bridge and the extension of the roadway are not part of the LRT project but the design of the Northern Alignment will not preclude the completion of the East River Road/Main Street SE connection in the future.

### 2.6.1.3 Washington Avenue to Northbound I-35W Connection

There is a proposal to construct a ramp from Washington Avenue to NB I-35W. Any changes to 4th Street/Washington Avenue would not affect the feasibility of adding this ramp.

### 2.6.2 Trails

East of Bridge 9, the Northern Alignment is designed to accommodate the trail that will be constructed on the south side of the alignment. This trail would follow the Northern Alignment to Oak Street SE and exit the railroad right-of-way alongside the track, connecting to 6th Street SE. At this point, trail users would be able to use the existing and planned sidewalk and trail system that will be incorporated into the street network.

The Northern Alignment would be designed to accommodate other trail connections that would not be part of the project.

## 2.7 Comparison of Washington Avenue and Northern Alignment

The Northern Alignment is 2,936 feet longer than the Washington Avenue Alignment; 11,166 feet versus 8,230 feet. However, the character of the alignment allows for a faster running. The faster running is due to the alignment's greater separation from surface development. While the Washington Avenue alignment is on the surface through the University, and within a pedestrian environment, the Northern Alignment is grade-separated for much of its length.

*The Northern Alignment is grade-separated for much of its length and allows for a faster running.*

Both alignments cross the Mississippi at locations with existing bridges. Although Bridge 9 would be completely replaced, the construction of the new bridge would have less impact on traffic than the modifications to the Washington Avenue Bridge. More importantly, Bridge 9 only carries a pedestrian trail versus the up to 25,000 ADT on the Washington Avenue Bridge. In the construction of the Northern Alignment, the Washington Avenue Bridge would not be affected versus the impact of the strengthening of the Washington Avenue Bridge. The Washington Avenue Alignment would require the closure of the Washington Avenue Bridge for up to two years.

Roadways in the West Bank area would be reconfigured, but this work would not require complete closure of any roadway as occurs with the Washington Avenue Alignment. For most of its distance, the Northern Alignment has no impact on the surrounding roadway system.

Furthermore, the impact on utility relocation of the Northern Alignment is very minimal, so much so that the amount of time devoted to utility relocation in the construction schedule would also be minimal, perhaps saving as much as a construction season.



### 3 Stations

The proposed Northern Alignment in the University segment of the CCLRT corridor would have three stations:

1. **West Bank** – at Cedar Avenue and 3rd Street S
2. **Dinkytown** – at University Avenue SE and 14th Avenue SE
3. **Stadium Village** – just south of the U of M Transitway between 23rd Avenue SE and 25th Avenue SE

All stations would be constructed with low platforms, 14-inches above the top of rail. The appropriate on-platform features would also be provided at each station, such as canopies, windscreens, fare machines, etc. All design features associated with the stations would be consistent with the specifications prepared for the CCLRT.

All stations would be accessible by foot and bicycle. There would be connecting bus transit at all stations and features that facilitate transfer between modes. The stations would also comply with all applicable ADA requirements (specific connections for each station are discussed below). No parking would be a part of the CCLRT, however the Stadium Village Station area is planned to accommodate a future multimodal transit hub with parking.

Stations locations were selected to serve the surrounding community in the most efficient manner possible. Transit supportive development exists at all of the stations. This includes the University of Minnesota, all three commercial districts that are adjacent to the campus, student oriented housing and medium to high-density residential neighborhoods. Future development and/or redevelopment will take advantage of the nearby CCLRT station.

*All design features associated with the stations would be consistent with the specifications prepared for the CCLRT.*

*All stations would be accessible by foot and bicycle. There would be connecting bus transit at all stations and features that facilitate transfer between modes. The stations would also comply with all applicable ADA requirements.*

#### 3.1 West Bank<sup>9</sup>

##### 3.1.1 Location

The station serving the West Bank of the U of M campus, Cedar Riverside and Seven Corners area would be located at Cedar Avenue S and 3rd Street S with the station platform situated under the south end of the new Cedar Avenue Bridge. The track alignment in this section would be parallel to and south of Washington Avenue (Figure 13; S1).

##### 3.1.2 Description

The West Bank Station may be described as a two-level station because components of the station are split between the level of the surrounding street system and the lower level of Washington Avenue. The station platform is at the lower level, centered on Cedar Avenue S and under the south end of the bridge (Figure 13; S1).

---

<sup>9</sup> **Note:** Additional enhancements are proposed in Chapter 8 that refines the alignment and mitigates potential impacts.



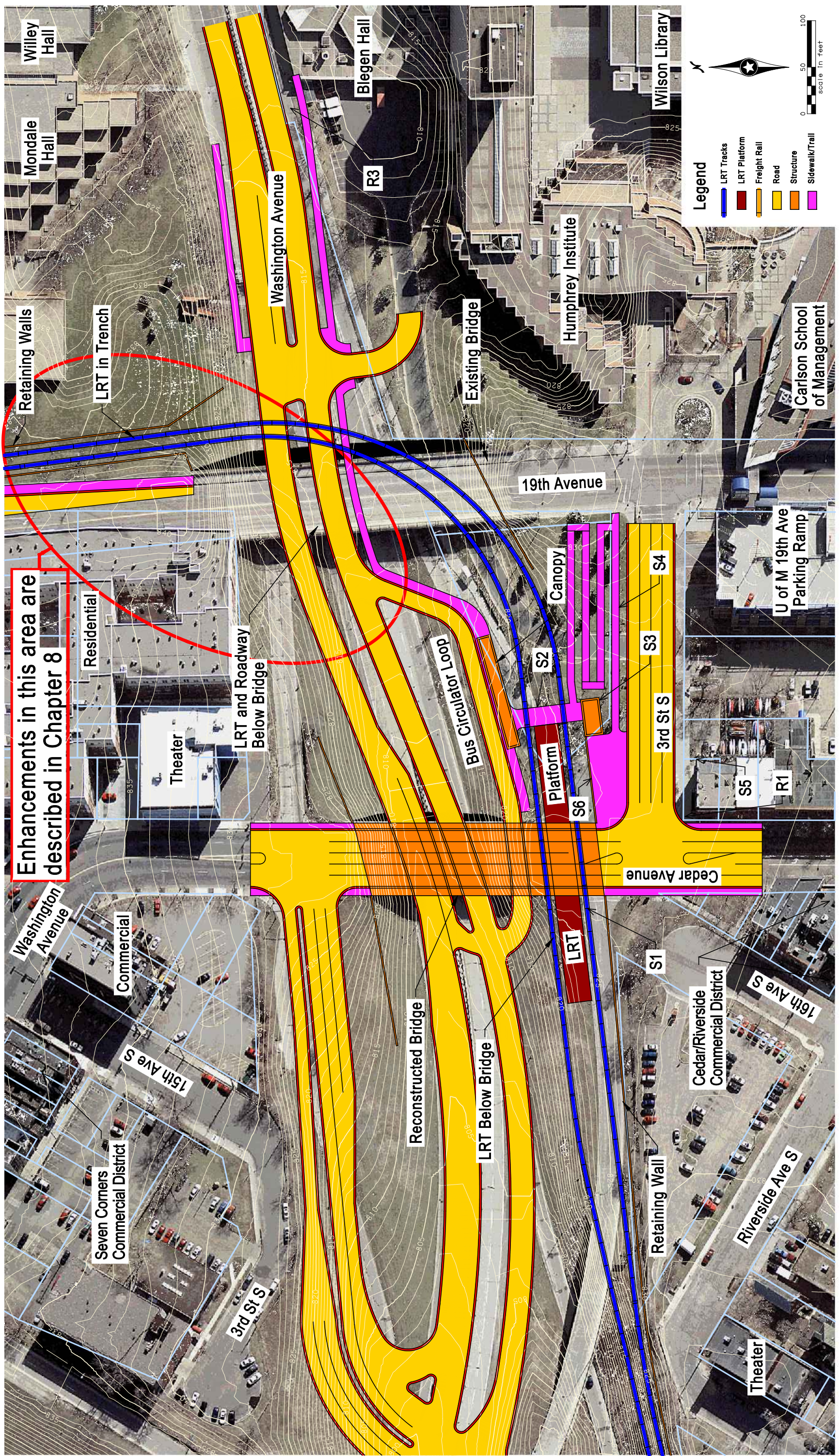

Enhancements in this area are described in Chapter 8

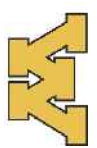

Since the Central Corridor Management Committee meeting of April 30, 2008, continued feasibility design development of the Northern Alignment has resulted in further enhancements which are described in Chapter 8 of this report.



This lower level also includes a bus circulator loop placed immediately adjacent to the east end of the platform to allow easy exchange of riders between LRT and buses (Figure 13). A track level walkway would cross both tracks at the east end of the station.

A ramp would rise from between the tracks to the level of the center platform (Figure 13; S2). Between Cedar Avenue S and 19th Avenue S, along 3rd Street S, a street level plaza and sidewalk would be constructed from which access to the station platform would be provided. A stair tower of sufficient size to provide stairs, two elevators and an enclosed lobby at both street and track levels would be situated opposite the east end of the platform (Figure 13; S3). There would also be a pedestrian ramp dropping from street level to track level in a switchback configuration (Figure 13; S4). In both cases, transit patrons would be directed to the track level crossing of the EB track to gain access to the platform or to the bus loop.

### 3.1.3 Access

#### **Pedestrian**

The street level pedestrian environment would not change radically from what it is today. The most significant difference would be the elimination of the existing plaza area on the north end of the commercial building occupying the east side of Cedar Avenue S south of 3rd Street S (i.e., Midwest Mountaineering) (Figure 13; S5). The plaza that would be constructed on the north side of 3rd Street S as part of the LRT station would be of similar size to the area eliminated (Figure 13; S6).

The Cedar Avenue S/3rd Street S intersection would be dramatically simplified and easier for pedestrians to manage because the west leg of the intersection would be eliminated (Figure 13; R1). The intersection on the north end of the Cedar Avenue Bridge would also be easier for pedestrians because the east leg of the intersection would be eliminated (Figure 13; R2).

*The Cedar Avenue S/  
3rd Street S intersection  
would be dramatically  
simplified and easier for  
pedestrians to manage.*

Because of the urban nature of the surrounding community, pedestrian access from all directions would be available through the use of the city sidewalk system and the extensive pedestrian system on the University campus.

#### **Bike**

No special provision for bicycle access to the station would be made. Bicyclists would approach the station using the City street system and the existing campus bicycle route network.

#### **Disabilities Accessibility**

The station would meet ADA requirements because of the provision of the switchback ramp and the provision of elevators connecting street level to track level (Figure 13; S3, S4).

#### **Bus Turnaround**

The redesigned Washington Avenue would have a bus turnaround provided at the level of Washington Avenue (Figure 13). A bus drop off station would be located at the LRT station. The Blegen Hall stop would not necessarily be eliminated (Figure 13; R3).

### 3.1.4 Existing Supporting Land Uses

The West Bank campus of the University of Minnesota occupies the area north and south of Washington Avenue adjacent to the Mississippi River, with the western boundary west of 19th Avenue S and the southern boundary along Riverside Avenue. West of 19th Avenue S, extending south along Cedar Avenue S and eastward on Riverside Avenue is a commercial district known as Cedar-Riverside (Figure 13). On the north side of Washington Avenue, west of 19th Avenue S is a commercial area known as Seven Corners (Figure 13). Both of these commercial districts are within a 1/4-mile radius of the station site.

South of Riverside Avenue S and north of I-94 is a small residential neighborhood of single-family homes, a large part of which is within a 1/2-mile radius of the station site. Also within a 1/2-mile radius of the station and within the Cedar Riverside Neighborhood is a residential complex known as Riverside Plaza, which includes a high proportion of lower income families, many of which are recent immigrants. North of the station in the Seven Corners area is a 265-room Holiday Inn. There are also several high-rise apartment buildings in the Seven Corners area and within a 1/4-mile radius of the station.

Southeast of the station, just outside the 1/2-mile radius, but on a connecting bus line, is Augsburg College, an undergraduate college with a total enrollment of 3,785 in 2007. North of Riverside Avenue from Augsburg College is the University of Minnesota Fairview Riverside Medical Center Campus, which will also benefit from the station.

The location of the station would be convenient to users of the U of M West Bank campus, the Seven Corners commercial area north of Washington Avenue and the Cedar-Riverside commercial area south of Washington Avenue. It would also be convenient to the residential buildings north of Seven Corners, those west of Cedar Avenue and the neighborhood south of Riverside Avenue.

## 3.2 East Bank <sup>10</sup>

### 3.2.1 Location

The station serving the East Bank of the U of M campus, Dinkytown and surrounding neighborhoods would be located at University Avenue SE and 14th Street SE with the station platform centered on this intersection and extending to the intersection of 4th Street SE to the east and to the site of the existing Dinkytown pedestrian bridge to the west. The track alignment in this section would follow the BNSF and U of M right-of-way.

---

<sup>10</sup> **Note:** additional enhancements are proposed in Chapter 8 that refines the alignment and mitigates potential impacts.



### 3.2.2 Description

The station platform would be split into two sections. The EB platform would extend from the University/14th Avenue intersection to the 4th Street SE/15th Avenue SE intersection, crossing this block from corner to corner (Figure 14). The westbound platform would extend from the University Avenue SE/14th Avenue SE intersection to the site of an existing pedestrian bridge that crosses the railroad alignment at street level, connecting Dinkytown to the campus. The platform would be oriented towards one of the tracks and would have a barrier separating the platform from the other track. The westbound platform and the eastbound platform would be connected by a 12-foot wide walkway (Figure 14; S1).

It is necessary to split the platforms because of the limited width within the existing below grade railroad corridor because of the many demands on the space. The requirements of the freight railroad, the proposed roadway (Granary Road) and the trail push the Northern Alignment to the south side of the existing below grade railroad corridor. As a result, the EB and WB tracks straddle a series of bridge piers, which were placed and aligned to be parallel to the railroad alignment. The station platform cannot be placed alongside the bridge pier because of insufficient width to meet ADA requirements. There is however, sufficient space to provide the connecting walkway.

Splitting the platforms, and the resulting increase in the overall length of the station, allows the establishment of vertical circulation at three locations, knitting the station more effectively to the street and pedestrian system.

In the middle of the station, at University Avenue SE and 14th Street SE, a stair tower of sufficient size to provide stairs, two elevators and an enclosed lobby at both street and track levels would provide primary access to the station (Figure 14; S2). At track level, transit patrons would cross the EB track to gain access to the station platform (Figure 14; S3). Access from the central stair tower would be to the walkway connecting the two platforms (Figure 14; S1). Because of the low platform associated with the low-floor light rail cars used in the Twin Cities, there is sufficient space to provide ramping from track level to the platform level to comply with ADA requirements. At street level, a small plaza would be provided that would be designed to act as a visual indicator of the presence of the LRT station (Figure 14; S4). It would also provide more space for pedestrian movement from the sidewalk area to the stair tower.

The east end of the EB platform would be near the intersection of 4th Street SE and 15th Avenue SE, at which a stair would connect the street level to the end of the platform (Figure 14; S5). At platform level, it would not be necessary to cross the tracks. At street level, there is already a small plaza, constructed as part of the complex bridge at this intersection that would be modified to act as a 'marker' similar to the plaza at the central tower.

*View showing the location of the Northern Alignment and part of the Dinkytown Station, southwest toward the University Avenue SE Bridge, a pedestrian bridge and downtown Minneapolis.*



*Splitting the platforms, and the resulting increase in the overall length of the station, allows the establishment of vertical circulation at three locations, knitting the station more effectively to the street and pedestrian system.*



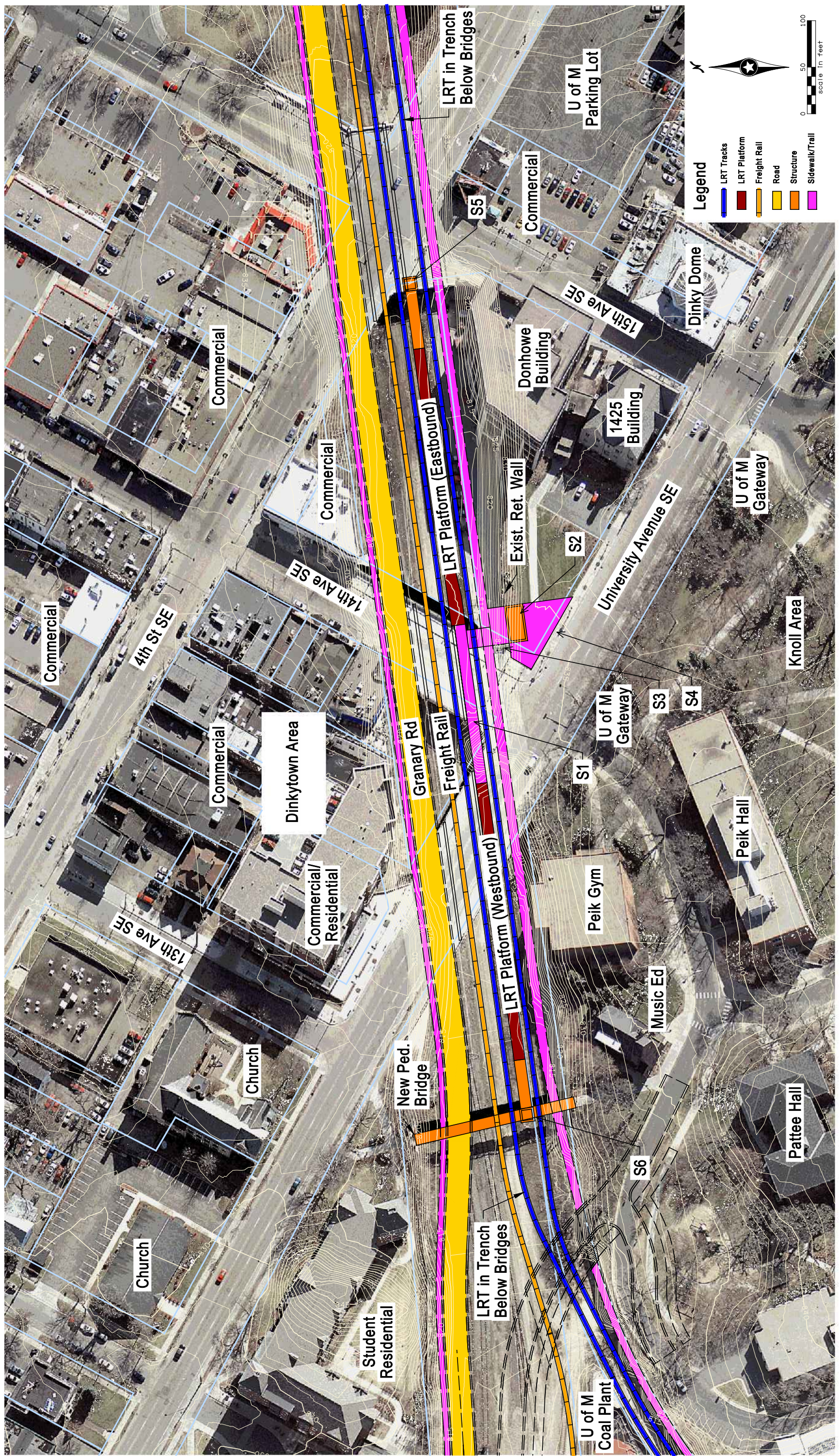



Near the west end of the WB platform, there is currently a pedestrian bridge. This bridge, currently closed because of structural issues, would be replaced and a stair provided connecting the new bridge to the WB platform (Figure 14; S6). The new pedestrian bridge would allow access from both sides of the below grade railroad corridor. In the same manner as the east stairs, a stairway would connect directly to the end of the WB platform.

The Dinkytown Station will draw not only University students, faculty and staff, which are predominately located north of Washington Avenue, it is also well situated to serve the transit dependent populations in Dinkytown and the adjoining Marcy Holmes neighborhood.

### 3.2.3 Access

Because of the urban character of the Dinkytown commercial area and surrounding neighborhoods, there is an extensive sidewalk and crosswalk network that facilitates pedestrian access to the station. This is also true of the adjoining campus. Both the City and University are continuing to make adjustments that remove barriers to those with disabilities in compliance with ADA requirements.

The station elements that provide vertical circulation between platform level and street level connect to the surface pedestrian system at three locations. The orientation of these access points reduces overall walk distance to the station platform.

### 3.2.4 Existing Supporting Land Uses

North of the University of Minnesota East Bank campus is a commercial area known as Dinkytown (Figure 14). Consisting of several blocks of restaurants, coffee shops, and specialty stores, this area represents a destination for both students and area residents. The unique character of the area also attracts residents from around the region for both shopping and entertainment.

The railroad alignment angles across the Dinkytown area below grade. At street level, the grid street system is maintained in this area with several roadway bridges that eliminate the barrier effect that would normally be associated with a railroad alignment. Since there is no apparent activity or vertical circulation to the railroad level, this area is slightly invisible to most drivers and pedestrians. Instead, the absence of buildings in the space above the alignment creates several view corridors that add to the character of the Dinkytown area. This includes an excellent view of the downtown Minneapolis skyline from several locations. The open space also expands the view of the University Minnesota campus entrance at 14th Avenue SE (Figure 14).

The location selected for the proposed station is centered on the intersection of University Avenue and 14th Avenue SE. Because University Avenue is the connection to the regional highway system and the street system is one-way, this intersection functions as a de-facto entry point into the Dinkytown area when approaching from the west or south by automobile. The open area created by the below grade railroad corridor accentuates this perception.

*View of the below grade railroad corridor, west toward the 5th Street SE Bridge, Dinkytown and downtown Minneapolis.*





North of Dinkytown is a neighborhood known as Marcy Holmes, which is entirely within a 1/2-mile radius of the proposed station site. This neighborhood is a combination of student-oriented rental properties and owner-occupied single-family residences.

### **3.3 Stadium Village**

#### **3.3.1 Location**

The station serving the U of M football stadium, U of M athletic district, Stadium Village and surrounding neighborhoods would be located between 23rd Avenue SE and 25th Avenue SE, on the south side of the University of Minnesota Transitway (Figure 15). The track alignment in this section would be transitioning from the U of M right-of-way to the University of Minnesota Transitway.

#### **3.3.2 Description**

The Stadium Village Station would be a surface station with side platforms. The station area would occupy the area between 23rd Avenue SE and 25th Avenue SE just south of the University of Minnesota Transitway. A transit and future multimodal hub plaza would be provided on the south side of the tracks that could be configured to allow daily and event transit to transfer patrons between transit modes.

#### **3.3.3 Pedestrian/Bicycle Access**

##### **Pedestrian**

The plaza would connect to sidewalks on 23rd Avenue SE and on 25th Avenue SE that would be situated parallel to and on the south side of the tracks (Figure 15; S1). Each of the side platforms would be accessible from ramps located at both ends of the platform. A pedestrian track crossing would be provided at each end of the station.

The neighborhood to the south and east is urban and character and therefore has an extensive network of sidewalks. In addition to the sidewalk system, a trail is proposed along the 25th Avenue SE, starting at the Transitway and proceeding north (Figure 15; R1). An intersecting trail is provided at 6th Street SE (Figure 15; R2).

Transit patrons approaching the station by bicycle will have to dismount when entering the station area, but all trains will have provision for carrying bicycles similar to the Hiawatha cars. In addition to the surrounding roadway system, bicyclists will be able to take advantage of the trails along the U of M Transitway, 25th Avenue SE, and 6th Street SE described above.

##### **Disability Accessibility**

There will not be any stairs or barriers to wheelchair use in the station area. As noted above, access to the platform will be by way of short ramps that will comply with ADA requirements. Sidewalks in the nearby neighborhoods are or will be provided with the appropriate curb treatments at each intersection or crosswalk.



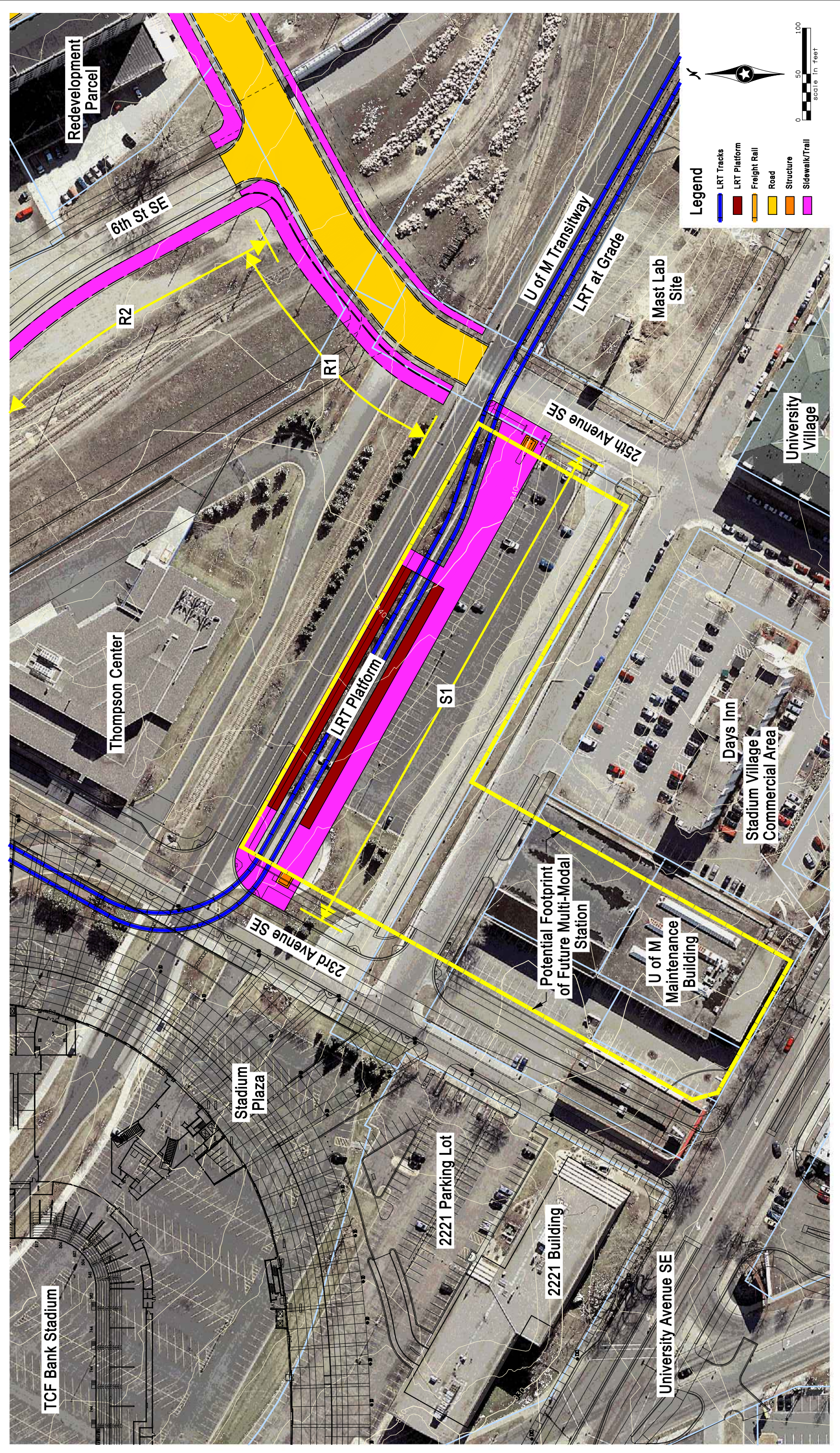

h:\projects\6399\HI-MULLAY\OUTFEASIBILITY STUDY\6399\_ StadiumStation.dgn



### 3.3.4 Existing Supporting Land Uses

The Stadium Village Station will be located on the Northeast corner of the University of Minnesota's Minneapolis campus (Figure 15). A 50,000-seat football stadium is already under construction one-block west of the station location. In addition to the football stadium, there are other athletic venues nearby including Mariucci Arena, which is a hockey arena, and Williams Arena, which is designed for basketball. These two arenas host U of M men's hockey and basketball respectively. Other athletic venues and related buildings are located in this area, including women's hockey and basketball and a natatorium. The Stadium Village Station is ideally suited to serve transit users attending or participating in sporting events at the University.

Adjacent to the station and extending several blocks to the south and west of the station is a commercial and medical research area known locally as Stadium Village (Figure 15). This is what may be described as a neighborhood commercial center because the mix of businesses includes restaurants, taverns and small convenience style food stores. There are also businesses, such as copy centers, that cater to the unique needs of the large college student population. An employment center epicenter, the U of M Medical Center employs over 4,500 people and serves countless patients each year.

South of this commercial area is medium density housing, also primarily serving the student population. Some of this housing is owned and managed by the University of Minnesota as on-campus dormitories. The balance of the housing is a mixture of medium sized apartment buildings and converted single-family homes. The most distant of these residential properties is within about a 1/2 mile of the station site.

One block southeast of the station is a 130-room Days Inn Hotel (Figure 15). Four blocks to the west is a 304-room Radisson Hotel.

South and east of the station are commercial and industrial uses, mainly on the north side of University Avenue SE and west side of 27th Avenue SE. Beyond this, but still within the 1/2-mile radius from the station, is another complex of apartment buildings and a single-family neighborhood known as Prospect Park-East River Road.

## 3.4 Comparison of Washington Avenue and Northern Alignment Stations

### West Bank Station

For the Northern Alignment, the West Bank Station is located farther to the west, centered on Cedar Avenue rather than 19th Avenue S. The Washington Avenue Alignment provides access from three locations, Cedar Avenue S, 19th Avenue S and the U of M skyway at Blegen Hall. The Northern Alignment would provide access from both Cedar Avenue S and 19th Avenue S, but not directly from Blegen Hall.

However, under the Northern Alignment, the redesign of Washington Avenue would allow the construction of a pedestrian walkway from Blegen Hall that would provide the same level of accessibility. Overall, U of M students may have a longer walk distance, but the station would be closer to the commercial areas of Cedar-Riverside and Seven Corners. It would also be closer to the high density housing west of Cedar Avenue.



### **East Bank and Dinkytown Stations**

The most significant difference between the two alignments is the location of the middle station. The East Bank Station on the Washington Avenue Alignment is on Washington Avenue near Union Street SE. The Dinkytown Station on the Northern Alignment is on the corner of 14th Avenue SE and University Avenue SE.

Although the station designs are very dissimilar, the main issue is the service area around the station locations. Each station would serve a different service area as shown on Figures 16 and 17. On the Washington Avenue Alignment, the entire U of M campus is within 1/2 mile of one of the three stations. On the Northern Alignment, several University buildings south of Washington Avenue and west of Harvard Street SE fall outside of the 1/2-mile radius. However, these buildings would still have transit service. Continuation of the Campus shuttle and Metro Transit busses would provide ready accessibility to either the West Bank or Stadium Village Stations from this area. Further, U of M statistics demonstrate that over 80 percent of the students with UPASSes are registered at colleges within a reasonable walking distance of the Dinkytown Station (see Figure 18). On the other hand, the Northern Alignment's Dinkytown station would expand service beyond the U of M to Dinkytown as well as the Marcy Holmes neighborhood.

### **Stadium Village Station**

The Stadium Village Station is virtually in the same location in both the Northern Alignment and the Washington Avenue Alignment and of similar design. The service area around each station should be the same, as would accessibility.